

And the light has come!

This year 2023 we are publishing our 7th edition of the 100%Chef & 100%Barman catalogue, in which we present our latest creations and selected additions, with the aim of continuing to promote the creative work of our customers.

We have been in our new headquarters next to Barcelona for almost two years and, in addition to having tripled the capacity of our facilities, with all the benefits that this entails, we have finally been able to inaugurate our own 100%Lab, a kitchen equipped with the most modern kitchen and bar machinery and accessories where we can test and evolve our equipment and create recipes, as well as videos and photographs of our latest tools, in an enlarged recording and editing studio.

Therefore, we increase our capacity to generate new technical and audiovisual material to share on Social Networks, showing day by day the small and big advances generated in this 100%Lab, highlighting and thanking the collaboration of the various sponsors who have wanted to join this initiative.

We complement this new opening with the creation of a new design and industrial engineering department, 100%Design, which will help us to satisfy the high professional demands of our designs and equipment.

So, let's talk about some of the new products coming out this year; from our new luminous bells, for restaurants and cocktail bars, as well as fluorescent plates that glow in the dark, glasses and cups filled with noble gases that light up with colored plasma beams when brought close to their base, to GN trays that illuminate the catering and beverage service. Also, backlit service trolleys made of state-of-the-art materials, so, at the last, the light was made.

A year in which we have established new and close partnerships with companies in the industry, thus contributing together to strengthen the creation and improvement of products and solutions, jointly expanding our offerings in international specialized distribution.

This year, in which nothing will be left in the dark, follow our latest news and you will surely see it more clearly.

Angel Salvador Esplugas

¡Y se hizo la luz!

**100%Chef**

Este año 2023 publicamos nuestra 7ª edición del catálogo 100%Chef & 100%Barman, en el que presentamos nuestras últimas creaciones e incorporaciones seleccionadas, con el objetivo de seguir impulsando el trabajo creativo de nuestros clientes.

Llevamos casi dos años en nuestra nueva sede al lado de Barcelona y, más allá de haber triplicado la capacidad de nuestras instalaciones, con todas las bondades que ello conlleva, hemos podido finalmente inaugurar nuestro propio 100%Lab, una cocina equipada con la más moderna maquinaria y complementos de cocina y bar donde probar y evolucionar nuestros equipos y crear recetas, además de videos y fotografías de nuestras últimas herramientas, en un ampliado estudio de grabación y edición.

Así pues, incrementamos la capacidad de generar nuevo material técnico y audiovisual que poder compartir en Redes Sociales, mostrando día a día los pequeños y los grandes avances generados en este 100%Lab, destacando y agradeciendo la colaboración de los diversos patrocinadores que han querido sumarse a esta iniciativa.

Complementamos esta nueva apertura con la creación de un nuevo departamento de diseño e ingeniería industrial, 100%Design, que nos ayudará a satisfacer las altas exigencias profesionales de nuestros diseños y equipos.

Hablemos pues ya de algunos de los nuevos productos que verán la luz este año; desde nuestras nuevas campanas luminicas, tanto para restaurante como coctelería, pasando por platos fluorescentes que lucen en la oscuridad, vasos y copas rellenos de gases nobles que se iluminan con rayos de plasma de colores al acercarlos a su base, hasta bandejas GN que alumbran el servicio de catering y de bebidas. También, carros de servicio retroiluminados fabricados en materiales de última generación, así que, por fin, se hizo la luz.

Un año en el que hemos establecido nuevos y estrechos lazos de colaboración con empresas del sector y contribuyendo así, entre todos, a fortalecer la creación y la mejora de productos y soluciones, ampliando conjuntamente ofertas en la distribución especializada internacional.

Este año, en el que nada quedará a oscuras, sigue nuestras últimas novedades y seguro que lo veras más claro.

Angel Salvador Esplugas

© 2023 - Cocina sin límites, S.L.

Imprenta / Print:  
Gráficas Grupo Giesa, Barcelona.

Fotografías / Photos:  
Cocina sin límites, S.L.  
Francesc Guillamet  
Frank Croes - [frankcroes.be](http://frankcroes.be)  
Vinyas Photography



5	Aladin
	Ahumado y aromatización · Smoking & Flavouring
25	Tool Concepts
77	Precision
	Higiene y medición · Hygiene and measurement
85	Sous Vide
	Cocina y técnicas al vacío · Vacuum cooking & techniques
107	Nitro
	Nitrógeno Líquido · Liquid Nitrogen & Dry Ice
119	Stone Age
151	PorceLand
173	Ceramics Era
187	Glass concepts
265	Hyperrealism
	Más allá de la realidad · Beyond Reality
275	Table Top
	Cutlery
319	Catering
363	BBQ
	Barbacoas · Barbecues
375	Inox
	Creatividad inoxidable · Stainless Creativity
397	Moulds
	Dale forma! · Shape it!





***Aladin***<sup>®</sup>  
Ahumado y aromatización  
Smoking & Flavoring

# Aladin Flavour 7

Aromatizador instantáneo para cócteles y cocina  
Instant aroma enhancer for cocktails and cooking



007 Flavour

10/0092 Gold

10/0091 Black

10/0082 Blue

007 Flavour© es el vaporizador aromático profesional diseñado especialmente para el uso en coctelería profesional y cocina, con el que aromatizar cócteles, bebidas y alimentos de forma espectacular, presentando pompas rellenas de vapor aromático de color blanco, que al romperse desprenden una densa niebla aromática. Rellena también envases, campanas o copas, generando el ambiente del aroma escogido.

007 Flavour© is the professional aromatic vaporizer designed specifically for use in the professional cocktail and culinary industry. It allows for spectacular aroma infusion in cocktails, beverages, and food, presenting bubbles filled with white aromatic vapor that, when burst, release a thick aromatic mist. It can also be used to fill containers, cloches, or glasses, creating a captivating aroma-filled ambiance.



**VAP sin nicotina**  
VAP without nicotine

Funciona con VAPS de aromas sin nicotina, fácilmente intercambiables y sin mezcla de sabores, tan solo saque y ponga un nuevo vaper.  
Works with nicotine-free aroma VAPS, which are easily interchangeable and do not mix flavors. Simply remove and replace the vaper with a new one.



**Aladin Cover©**

Con conexión rápida para nuestras campanas con válvula Aladin Cover© y Aladin CD©, obteniendo un vapor controlado, más aromático y estable dentro de copas, vasos, etc...  
With quick connection for our Aladin Cover© with valve and Aladin CD©, providing controlled, aromatic, and stable vapor within the glasses, cups, etc.













Aromatizador 007 Flavour, 4 VAPS, 2 baterías 9V recargables, cable de carga, manual de instrucciones, botella de Mixture Bubbler 100 ml

007 Flavour aromater, 4 VAPS, 2 rechargeable 9V batteries, charging cable, instruction manual, 100 ml Mixture Bubbler bottle.

## 007 FLAVOUR VAPS

Cargas de vapor aromatizado sin nicotina.  
Más de 120 aplicaciones con carga máxima.

Nicotine-free flavored vapor cartridges.  
Over 120 applications with full charge.

-  10/0078 Menta / Mint
-  10/0095 Chocolate Coffee
-  10/0099 Puro Habano Cigar
-  10/0097 Lavanda / Lavender
-  10/0096 Canela / Cinnamon
-  10/0079 Manzana Verde / Green Apple
-  10/0081 Citronela / Lemongrass
-  10/0077 Arándanos / Blueberries
-  10/0080 Plátano / Banana
-  10/0076 Piña / Pineapple
-  10/0093 Neutro / Neutral



10/0089  
Mixture Bubbler 200 ml

Gel especial para generar pompas rellenas de aroma. Este producto está autorizado para uso comestible. Compatible con otros modelos.

Special gel for creating aroma-filled bubbles. This product is approved for edible use. Compatible with other models.



10 uds  
pcs

10/0098  
VAP Rellenable / Refillable VAP

Rellene su VAP con 5 ml de esencias especiales para VAPS con el aroma escogido.

Fill your VAP with 5 ml of special essences for VAPS with the chosen aroma.



10/0083  
Conversion Kit

Transforme su Ahumador Super Aladin o 007 en un potente vaporizador con aromas y genere pompas rellenas de aromas o rellene campanas u otros recipientes con vapor aromático.

Transform your Super Aladin or 007 Smoker into a powerful aroma vaporizer, capable of creating aroma-filled bubbles or filling cloches and other containers with aromatic vapor..

100% Barman

# Genius Bubble - Kit

Instant Bubble Smoker  
and Aromatizer

Genius Bubble Kit genera de forma instantánea pompas transparentes sobre bebidas y recipientes con o sin humo. Aromatiza el humo con distintas maderas, aceites esenciales o tabacos saborizados para shisha. Además, funciona como ahumador instantáneo para campanas o recipientes cerrados.

Genius Bubble Kit instantly generate transparent bubbles on drinks and containers with or without smoke. Flavours the smoke with various woods, essential oils or flavoured shisha tobaccos. Also works as an instant smoker in closed cloches or containers.

10/1000  
Genius Bubble-Kit



Burbujas de gel alimentario  
Food grade gel bubbles

10/0089  
Mixture Bubbler 200 ml



# Super Aladin®

Ahumador  
Aromatizador Profesional  
Professional Flavouring  
Smoker

Super Aladin® es el único ahumador manual totalmente metálico, resistente al empleo diario o semi-industrial. La doble cámara permite combinar el ahumado con aromas y aceites esenciales.

Entirely made with aluminium, SuperAladin® is a unique heavy-duty indoor food smoker specially designed for professional use. Add extra scent to any recipe using the double chamber, combining essential oils and smoke.



Fácil limpieza, reparación y mantenimiento  
Easy cleaning, repair, and maintenance



Con doble cámara  
de aromatización  
With double  
aromatization  
chamber



Instrucciones en el interior  
User manual inside

Hélice de aluminio  
Aluminium fan

Nuevo interruptor frontal  
New easy switch







Videos completos  
técnicas de ahumado  
Full videos  
smoking techniques

**FREE EXTRA CONTENT**



AHUMADO EN CUBETA  
GASTRONORM FOOD SMOKING



10/0033

Tapa Gastronorm 1/1 con válvula  
Gastronorm lid 1/1 with valve

### Aladin Station

Ahora puede trabajar con su Super Aladin® totalmente horizontal, evitando la entrada de resina en el motor. ¡Humedezca el serrín tanto como quiera!

Work with your Super Aladin® in a flat position, preventing resin from entering the engine. An easy way to control the humidity of the sawdust!



10/0031  
Aladin Station



# Aladin®

Accesorios y complementos para Aladin, Super Aladin, 007 y Flavour  
 Accessories and complements for Aladin, Super Aladin, 007 and Flavour

10/0010  
 Super Aladin Rotor



10/0048  
 Super Aladin y 007  
 Conexiones eléctricas interruptor frontal  
 Electrical spare parts - frontal switch



10/0030  
 Super Aladin y 007  
 Conexiones eléctricas interruptor en la base  
 Electrical spare parts - bottom switch



10/0012  
 Heavy Wheel Kit

Motor con hélice  
 Engine with fan

10/0032  
 Motor / Engine

10/0100  
 007 Flavour  
 Conexiones eléctricas  
 Electrical spare parts



5 uds  
 pcs

10/0005  
 Aladin Filtros XS  
 Aladin Screens

Super Aladin  
 Ø 19 mm

5 uds  
 pcs

10/0006  
 Aladin Filtros XL  
 Aladin Screens

Super Aladin - Aladin 007  
 Ø 26 mm

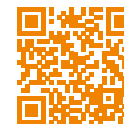

Tutorial de cuidados y mantenimiento  
 Maintenance and care video guide

**FREE EXTRA CONTENT**





Técnicas de ahumado  
para coctelería  
Smoking techniques  
for mixology

**FREE EXTRA CONTENT**

# Aladin 007®

Ahumador  
aromatizador  
Flavourer smoker

Aladin 007® es el ahumador profesional preferido por los bartenders de todo el mundo. Con Aladin 007, la técnica del ahumado frío sin combustión permite la incorporación de aromas añadidos y aceites esenciales, generando nuevas y creativas aplicaciones del ahumado en sus bebidas.

Aladin 007® is the most requested professional handheld smoker, specially designed for Bartenders. Add the powerful flavor of cold smoke to the cocktails really easy. Explore the intriguing scents that Aladin 007® can reveal in your drink creations.



10/1009  
Aladin 007 / Black Edition



Disco Aladin CD  
incluido en el kit  
Aladin CD  
included.

↓  
RECAMBIO  
SPARE PART



10/0012  
Heavy Wheel Kit



10/0009  
Aladin 007





10/0028  
Virutas de toneles  
Jack Daniel's  
Wood Chips

800 gr

## Aladin® Chips

Serrín para ahumado  
Smoking Sawdust

80 gr

10/0004	Haya / Beech Wood
10/0027	Roble / Oak Wood
10/0042	Jack Daniel's Original Tennessee Whiskey
10/0052	Olivo / Olive Wood
10/0054	Almendro / Almond Wood



## MATRIX·OSKA

Matrioska clásica pintada a mano, con válvula integrada para ahumar. Sorprenda a su cliente al abrir la muñeca.

Hand-painted classic Matryoshka doll with integrated smoking valve. Surprise your customer when opening the doll.

10/0060  
Matrix-Oska

Ø 10 cm - Altura / Height: 23 cm  
Interior / Internal: Ø 7.8 cm



Base de mármol  
Marble base

10/0061  
Ahumador para vasos  
Glass smoker

Ø 9.5 cm  
Altura / Height: 7 cm



# VOLCANO

Con un ingenioso cráter en el centro, este vaso de borosilicato, permite que el humo generado en la parte inferior pase, ahumando cualquier bebida. La base de mármol negro añade a la bebida un toque de elegancia y sofisticación.

With an ingenious crater in the center, this borosilicate glass allows the smoke generated at the bottom to pass through, infusing any beverage with a smoky flavor. The black marble base adds a touch of elegance and sophistication.



Con hielo seco  
With dry ice



Con serrín para ahumado  
With smoking Wood Chips



160/5095  
Volcano

Ø 18 cm  
Alt / Height 19 cm

10/0084  
Campana Ambar  
Ambar cloche



Ø 18 cm - Alt / Height 19 cm



## Campana Ambar "15 Aniversario"

Celebra con nosotros los 15 años del lanzamiento de nuestra primera campana con válvula Aladin, un modelo que ha sabido mantener su estilo, además de ser imitada por otros fabricantes.

En este aniversario presentamos una nueva versión fabricada con vidrio de borosilicato ambar transparente.

## Ambar cloche "15th Anniversary"

Celebrate with us 15 years since the launch of our first Aladin valved cloche, a model that has maintained its style and has been imitated by other manufacturers.

On this anniversary we present a new version made of amber borosilicate clear glass.



## Campanas para ahumado Smoking glass cloche

Aladin Cover® fué la pionera, el primer modelo de campanas con válvula que permiten la inyección de humo y aromas en los platos o recipientes para el servicio, sin tener que levantarlas.

Aladin Cover® was the creator of the first model of cloches with a valve that allows the injection of smoke and aromas into dishes or containers for service, without the need to lift them.



## Campana Aladin con válvula Aladin cloche with valve

10/0043    Ø 14 cm

10/0044    Ø 18 cm



10/0019  
Válvulas de silicona de recambio  
Replacement silicone valves

## Campana Aladin con válvula Aladin cloche with valve

10/0013    Ø 14 cm

10/0015    Ø 18 cm

10/0022    Ø 9 cm

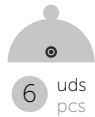

## Campana Aladin sin válvula Aladin cloche without valve

10/0014    Ø 14 cm

10/0016    Ø 18 cm

10/0023    Ø 9 cm

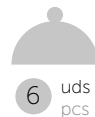



Fabricadas en borosilicato, extremadamente resistente al choque térmico.

Made with borosilicate glass, extremely resistant to thermal shock.

10/0039

Campana Buffet  
Buffet Cover

Ø 25 cm

Alt / Height: 21 cm



Buffets de quesos, pescados ahumados, barbacoas...

Buffet of cheese, smoked fish, barbecue to share...

**GastroNaut**  
cover

Elegantes e icónicas, estas nuevas campanas permiten presentar platos con humo, vapores aromáticos y hielo seco, convirtiéndose en unas auténticas herramientas gastronómicas.

Sleek and culinary-focused, these new cloches enable the presentation of dishes with smoke, aromatic vapors, and dry ice, transforming them into authentic culinary tools.

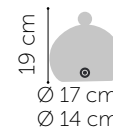

Gastronaut

10/0066 Campana sin válvula / Dome W/O valve

10/0063 Campana con válvula / Dome with valve



10/0017  
Campana Tajine con válvula  
Tajine plate cover with valve

10/0018  
Campana Tajine sin válvula  
Tajine plate cover without valve



160/0042  
Jarra Humo Frio  
Cold Smoke Pitcher

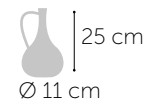

10/0046  
Campana Jarra XS  
Pitcher shaped cover XS

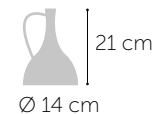

10/0047  
Campana Jarra XL  
Pitcher shaped cover XL

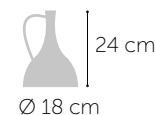

### Aladin CD

Conecte cualquier modelo Aladin a todo tipo de envases, vasos, cocteleras, sifones, tarros de conserva, etc.

Connect any model of Aladin Smoking Gun to any container, glass, cocktail shaker, siphon, or jar.



10/0029  
Aladin CD  
Ø 12 cm

XL Compatible con base iluminada 10/0085  
XL Compatible with illuminated base 10/0085



## Campanas Mixologist

Ahora podrá ahumar todas sus copas de cóctel con nuestras campanas Mixologist con válvula. Fabricadas en borosilicato, transformarán una presentación convencional en un regalo precioso para su cliente.

## Mixologist Cloches

Designed to fit any kind of cocktail glass, the Mixology Cloches are the detail that can transform a lousy drink presentation into a precious gift only for your customer's eyes.



Fabricadas en borosilicato, extremadamente resistente al choque térmico.  
Made with borosilicate glass, extremely resistant to thermal shock.



**A**  
10/0035  
Campana Cocktail  
Cocktail Cover

**B**  
10/0034  
Campana Long Drink  
Long Drink Cover

2 uds  
pcs

## LightYear Kit

10/0065

Kit Campana sin válvula / Dome W/O valve Kit

10/0064

Kit Campana con válvula / Dome with valve Kit

El kit se compone de campana, tapa de silicona, disco luz led, mando a distancia. Pilas no incluidas.

The kit includes a cloche, silicone lid, LED light disc, and remote control. Batteries not included.



## Campanas iluminadas

Campanas iluminadas con bases de luz LED, perfectas para crear una experiencia visual única gracias a las decenas de colores personalizados, diferentes intensidades y efectos temporizados. Diseñadas en respuesta a las peticiones de nuestros clientes, estas campanas son la solución segura para colorear el humo o vapor sin comprometer la salud. Además, el disco de luz es totalmente impermeable y podrá sumergirlo en una cubitera y lograr que el hielo adquiera tonalidades vibrantes y envolventes. ¡Transforme sus bebidas y emplatados en auténticas obras de arte!

## Light covers

Illuminated cloches with LED light bases, perfect for creating a unique visual experience with dozens of customized colors, different intensities, and timed effects. Designed in response to our customers' requests, these cloches are a safe solution for coloring smoke or vapor without compromising health. Additionally, the light disc is completely waterproof, allowing you to submerge it in an ice bucket and achieve vibrant and immersive color tones on the ice. Transform your drinks and platings into true works of art!



## LightYear Cloche

10/0074 Repuesto campana con válvula  
Replacement cloche with valve

10/0075 Repuesto campana sin válvula  
Replacement cloche without valve



18 cm  
Ø 17 cm

10/0070  
Silicona repuesto  
Spare silicone

Ø 13 cm  
Alt / Height: 4 cm



10/0071  
Luz LED repuesto  
Spare LED light

Ø 9 cm  
Alt / Height: 3,5 cm



## Long Drink Tube

Versátil campana tubular de doble posición con válvula para inyección de humo o vapor aromático. Con dos bases de iluminación independientes, permite combinar diferentes colores para crear un efecto de degradado.

Versatile double-position tubular cloche with valve for injection of smoke or aromatic vapor. With two independent lighting bases, it allows combining different colors to create a gradient effect.



### 10/0087 Kit Long Drink Tube

El kit se compone de campana tubular, base de madera, tapa de metacrilato, 2 discos de luz led, doble mando a distancia, soporte superior en silicona.

The kit consists of a tubular cloche, wooden base, acrylic cover, 2 LED light discs, double remote control, and a top silicone stand.

### 10/0069 Long Drink Tubo repuesto Long Drink Spare Tube

Ø 13 cm Alt / Height: 30 cm

### 10/0086 Base Long Drink con luz RGB Long Drink base with RGB light

Ø 16 cm Alt / Height: 5 cm



Long Drink Tube



10/0085  
Base Cocktail

Ø 21 cm Alt / Height: 5 cm  
El kit incluye: Base Cocktail, tapa de metacrilato, disco de luz LED RGB y mando a distancia.

The kit includes: Cocktail base, acrylic lid, RGB LED light disc, and remote control.

10/0101  
Kit Base Cocktail

El kit incluye: Campana Cocktail, Base Cocktail, tapa de metacrilato, disco de luz LED RGB y mando a distancia.

The kit includes: Cocktail cloche, Cocktail base, acrylic lid, RGB LED light disc, and remote control.



10/0085 + 10/0047  
Base Cocktail + Campana Jarra XL  
Base Cocktail + Pitcher shaped cover XL

## Base Cocktail

Esta base de madera natural con luz LED está diseñada especialmente para nuestras campanas Cocktail. Dé un toque de iluminación sofisticada a sus cócteles y bebidas mientras permanecen delicadamente cubiertos por la campana. Incluye una base de madera de cerezo, una tapa de metacrilato y un disco de luz RGB con mando a distancia, proporcionando un control total sobre la ambientación.

This wood base with LED light is specially designed for our Cocktail cloches. Add a touch of sophisticated illumination to your cocktails and beverages while they remain delicately covered by the cloche. It includes a cherry wood base, an acrylic lid, and an RGB light disc with a remote control, giving you complete control over the ambiance.



10/0086  
Base Long Drink con luz RGB  
Long Drink base with RGB light

Ø 16 cm Alt / Height: 5 cm

Base de madera lacada negra  
para campanas Long Drink de  
16 cm de diámetro

Black lacquered wooden  
base for 16 cm diameter  
Long Drink cloches



10/0102  
Kit Base Long Drink

2 uds  
pcs

Incluye 2 Kits completos de:  
Campana Long Drink, Base Cocktail, tapa  
de metacrilato, disco de luz LED RGB y  
mando a distancia.

Includes 2 complete Kits:  
Cocktail cloche, Cocktail base,  
acrylic lid, RGB LED light disc, and  
remote control.







| Tool Concepts



# VOM

EDIBLE CLOUD



Mire los vídeos de VOM  
en la web oficial  
Watch the VOM videos  
on the official website

**FREE EXTRA CONTENT**

## Un concepto para mentes voladoras

VOM es una nueva técnica que genera nubes voladoras de finas burbujas rellenas de gas helio, con infinidad de sabores y aromas, conformando nubes, figuras, discos o formas creativas que flotan y se elevan en el aire. Esto es posible gracias a las propiedades de su fórmula y sus múltiples accesorios.

Bartenders, Chefs y Pasteleros: con VOM la imaginación vuelve al poder. Ilimitadas posibilidades, recetas y sobre todo la sorpresa y admiración de sus clientes.

Estos etéreos bocados los podrá servir tanto como elemento decorativo, gustativo o efecto WOW.

## A concept for flying minds

VOM is a new technique that generates flying clouds of fine bubbles filled with helium gas, with an infinite number of flavours and aromas, forming clouds, figures, discs or creative shapes that float and rise in the air. This is possible thanks to the properties of its "Formula 1" emulsion and its multiple accessories.

Bartenders, Chefs and Pastry Chefs: with VOM, imagination comes back to power. Unlimited functions, recipes and above all the surprise and admiration of your customers.

These ethereal bites can be served as a decorative or gustatory element or to play with a WOW Effect.

Una técnica gastronómica con la que explorar y descubrir  
A new gastronomic technique to explore and discover

Infinitas formas de presentación y utilización  
Infinite ways of presentation and use

Presente aires comestibles o aspirables con sabor de forma original  
Present edible or breathable airs with flavor in an original way

El helio confiere el efecto de afinar la voz durante  
unos segundos si se aspira la suficiente cantidad  
Helium confers the effect of tuning the voice for  
a few seconds if enough quantity is breathed in





La nube se mantiene estable de 4 a 5 minutos dependiendo del PH del producto

VOM clouds remain stable for 4 to 5 minutes depending on the PH of the product



Efecto lluvia / Rain effect

Conexión rápida, fácil y segura

Quick, safe and easy connection

Regule la intensidad de salida del gas para cambiar el tamaño de las burbujas de helio según sus necesidades.

Adjust the gas output intensity to change the size of the helium bubbles according to your needs.



Incluido en el Kit Básico  
Included in Basic Kit

### Kit Técnico para gran consumo High Consumption Technical Kit

Debido a que cada país tiene diferentes tipos de conexiones, indiquenos el país de destino cuando haga su pedido o consulte este código QR

Because different countries have different types of connections, please indicate the Country of destination when placing your order or check this QR code



Mano reductor especial para cilindros de helio con conexión específica para ser adaptado a la válvula del Kit Básico VOM.

Special pressure reducer for pure helium cylinders, designed with specific connection to adapt it to the valve of the Basic Kit VOM.



Max 6 ATM

100/4000	Kit VOM Basic
100/4001	Kit VOM Basic USA

**Kit VOM BASIC** Este kit se compone de:  
This kit contains:



## SUBE DE NIVEL TAKE IT TO THE NEXT LEVEL

Ofrece la experiencia completa con nuestros kits \*  
Offering the complete experience with our kits \*

**\*Kit VOM PRO** Este kit se compone de:  
This kit contains:



**\*Kit VOM PREMIUM** Este kit se compone de:  
This kit contains:



\* Debido a que cada país tiene diferentes tipos de conexiones, indíquenos el país de destino cuando haga su pedido o consulte en la página web: [www.100x100chef.com](http://www.100x100chef.com).

\* Because different countries have different types of connections, please indicate the Country of destination when placing your order or check the website: [www.100x100chef.com](http://www.100x100chef.com)

# VOM EDIBLE CLOUD ACCESSORIES

Complete su kit básico con múltiples accesorios y conexiones especiales para grandes consumos

Complement your basic Kit with various accessories to continue surprising your guests with new effects.

## Vasos / Glasses

100/4003	Cuadrado / Square
100/4004	Tubo / Tube
100/4002	Cloud



4 uds  
pcs

100/4015  
Rejillas VOM  
Grids VOM

3 uds  
pcs

100/4016  
Domador VOM  
Ringmaster VOM

37 cm



Corte la nube, muévela y posicónela en el holder  
Cut the cloud, move and position it on the holder

100/4018  
Base silicona VOM  
Silicone Base VOM





100/4046  
Cala VOM

26 x 60 cm  
Alt / Height: 105 cm

6 uds  
6 pcs



100 g

Para más de 400 m de nube  
For more than 400 m of cloud

100/4017 Fórmula 1 VOM

100/4028 Fórmula 2 VOM\*

\* Fórmula bajo regulación FDA.

\* Formula under FDA regulation.

¿A qué saben las nubes?  
Sirve tus nubes voladoras sobre Cala para que  
puedan ser aspiradas. Crea una experiencia  
única en tu menú o tus cocktails más atrevidos.

What do clouds taste like?

Serve your floating clouds over Cala so they can  
be inhaled. Create a unique experience in your  
menu or your boldest cocktails.



# VOM

## TROLLEY

El VOM Trolley ha llegado para brindar a sus clientes una experiencia única, el impactante proceso de creación de nubes voladoras comestibles desde el carrito.

Combina ligereza, tamaño compacto y estabilidad. Sus ruedas se adaptan a cualquier superficie.

Está fabricado con el avanzado material "Solid Surface" que garantiza fácil limpieza y resistencia duradera.

The VOM Trolley has arrived to provide your customers with a unique experience—the breathtaking process of creating edible floating clouds right from the cart.

It combines lightness, compact size, and stability. Its wheels adapt to any surface. It is made with the advanced material "Solid Surface" ensuring easy cleaning and lasting durability.

100/0400  
VOM Trolley

26 x 60 cm  
Alt / Height: 105 cm

Personalice su VOM Trolley con logo, iluminación y colores corporativos.

Customize your VOM Trolley with your logo, customized lighting, and corporate colors.

No incluye grifería ni accesorios. Diseñado para ir equipado con un Kit técnico VOM y una botella de helio de 5 litros.  
Faucets and accessories are not included. Designed to be equipped with a VOM technical kit and a 5-liter helium bottle.

**Un espectáculo en la mesa para sus comensales**  
**An amazing show cooking for your customers**



Máxima Dureza  
Resistencia a la abrasión  
Resistencia a la humedad  
Impermeable y fácil limpieza



Maximum hardness  
Abrasion resistance  
Resistance to humidity  
Waterproof and easy to clean





Holders - Acrílico / Acrylic

100/4012	Drink S	10	uds pcs
100/4013	Drink L		
100/4014	Food		



Holder - Cobre /Copper

100/4011	Food	6	uds pcs
----------	------	---	------------

# VOM EDIBLE CLOUD HOLDERS

Soportes en 3 tamaños y 4 materiales para sostener la nube encima de vasos o platos, dejando que llueva frente a los comensales.

Stands in 3 sizes and 4 materials to hold the cloud on top of glasses or plates, letting it drip in front of the diners.



Holders - Inox / Stainless Steel

100/4008	Drink S	6	uds pcs
100/4009	Drink L		
100/4010	Food		



Holders - Titanium Negro / Black

100/4005	Drink S	6	uds pcs
100/4006	Drink L		
100/4007	Food		



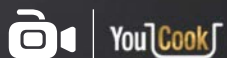

TECHNIQUES & RECIPES AT:  
www.100x100barman.com

# foamkit deluxe

50/0052  
Foam Kit



 Nuevo manual con técnicas y recetas incluidas  
New manual with techniques and recipes included



BOQUILLAS  
NORMALES  
COMMON  
NOZZLES



FOAM KIT

Acero inoxidable AISI 316  
Stainless steel nozzle



## Producción sencilla de aires y espumas

Cree en segundos "aires" homogéneos y estables, de forma continuada o de forma puntual, sin tórnix. Produzca aires con lecitina de soja, sucroester, o agentes espumantes, además de airear grasas fundidas. Foam Kit permite con muy poca cantidad de líquido, recoger tanta espuma como necesite controlando su producción tan solo pulsando un botón, sin necesidad de enchufes o cables, ya que funciona con 2 pilas. La base aireadora de acero inoxidable, garantiza una producción estable y de gran calidad, y permite una limpieza estricta después de cada producción.

## The easiest way to create foams and airs

Obtain homogeneous and stable foams within seconds with this special filter foamer without needing an immersion blender. It works even with small amounts of liquid. Add any foaming agent or stabilizer, as soy lecithin, sucroester. It works also with melted fat. Make as much foam as you want, controlling the production just by pushing a button. The compressor is operated by two batteries, so the device can be used anywhere.

The Foam-Kit nozzle is made with food-grade stainless steel that makes it really easy to clean thoroughly.



FOAM KIT + SOY LECITINE



EXTRA VIRGIN OLIVE OIL AIR



LIOFILIZADORA

Con Lyo Chef la tecnología de la liofilización es accesible a cualquier cocina o bar. Con un espacio de 5 y 6 bandejas respectivamente, se han diseñado para ser perfectamente integradas en las instalaciones de restaurantes, obradores, coctelerías y talleres de creatividad.

Permiten cubrir las necesidades de producción y elaboración de cartas y menús; optimizando la organización del trabajo gracias a la posibilidad de trabajar continuamente.

Lyo Chef aumenta radicalmente la vida útil de los productos en cualquier establecimiento, facilitando su estocaje y conservando intactas las características de los alimentos (color, sabor, aroma). También permite obtener texturas y elaborar bocados únicos a las mentes más creativas.

Lyo Chef incluye: Bomba de vacío premium, Aceite, Filtro de aceite, Jarra decantadora, Bandejas de acero inox (5 o 6 según modelo), Manual de uso, Bolsas Mylar (50 uds), Oxigen absorber (50 uds), Barra de sellado 40 cm.

Lyo Chef includes: Premier Oil Vacuum Pump, Oil, Decanter jar, Oil Filter, Stainless Steel Trays (5 or 6 depends on model), Guide to Freeze Drying, Mylar Bags (50 ct), Oxygen Absorbers (50 ct), Impulse Sealer 40 cm.

**0,435m<sup>2</sup> superficie de secado**  
**drying surface**  
**x 24 h**

**0,714m<sup>2</sup> superficie de secado**  
**drying surface**  
**x 24 h**







70/0053  
 Recambio Filtro aceite para bomba x 3  
 3 x Pump oil filter Replacement



Bomba de Vacío Premium  
 Premier Oil Vacuum Pump



70/0050  
 Aceite Recambio Lyo Chef  
 Spare Oil for Lyo Chef



LYOPHILIZER

With Lyo Chef, the technology of freeze-drying becomes accessible to any kitchen or bar. Designed with 5 and 6 trays respectively, these units seamlessly integrate into restaurant facilities, bakeries, cocktail bars, and creative workshops. They effectively meet the production and preparation needs of menus and dishes, optimizing workflow organization by enabling continuous operation. Lyo Chef significantly extends the shelf life of products in any establishment, facilitating storage while preserving the color, flavor, and aroma of the food. It unlocks endless possibilities for creative minds, allowing the creation of unique textures and bites.

Puede parametrizar y automatizar los procesos.

Parameterize and automate processes.

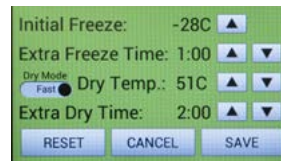

Tiempo de secado extra para productos con mayor humedad.

Extra drying time for products with higher humidity.



Descongelación forzada de la cámara para limpieza.

Forced defrosting of the cleaning chamber.





# Caviar-Box®

Más de 96 esferas  
por segundo  
More than 96 spheres  
for second

Caviar Box® es el accesorio ideal para trabajar la técnica de la esferificación: permite elaborar de forma muy rápida, una gran cantidad de bolitas de caviar líquido con mucha precisión. Ideal para alta restauración, banqueting y cocktail.

Caviar Box® is our best seller to realize the spherification technique. Produce precisely and quickly a large amount of imitation caviar. Designed to fasten the preparation for cocktail bars and catering.



20/0002  
Caviar Box desmontable  
Disassemblable Caviar Box

FÁCIL  
EASY

TOTALMENTE DESMONTABLE  
FÁCIL LIMPIEZA

FULLY DISASSEMBLABLE  
EASY TO CLEAN



12 uds pcs  
100/0048  
Lata dorada personalizable  
Customizable gold can

30 ml

Ø 6.5 cm Altura / Height: 2 cm

3 uds pcs  
20/0003  
Siliconas de recambio Caviar Box  
Caviar Box silicones replacement





100/0047  
 Latas de caviar Imitation  
 Caviar Imitation Cans

12 uds  
 pcs

30 ml

Ø 6.5 cm Altura / Height: 2 cm



Recetas en el interior  
 Recipes included



3 X

MEDIDAS BOQUILLAS  
 NOZZLES MEASURES

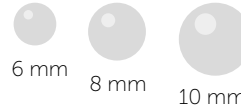

20/0006  
 Reverse Sphere Dispenser Kit

El kit incluye cuchara coladora  
 Strainer Spoon included



## Reverse Sphere®

Hasta 100 esferas por minuto  
 Up to 100 spheres for minute

Reverse Sphere® es el dosificador para la esferificación inversa o directa. Elabore sin esfuerzo esferas líquidas con tres diámetros diferentes. Produzca perlas líquidas con mucha antelación sin que endurezcan, para disponer en su mise en place de perfectas bombas de sabor sin apenas dedicación.

Reverse Sphere® has been developed to ease the production of a large amount of small liquid spheres by reverse or direct spherification with a minimum effort. Chose between the three diameters included in the kit, and produce little bursts of flavor for your plates well in advance.

Esferificación  
 fácil y rápida  
 Easy and quick  
 spherification



**FREE EXTRA CONTENT**



# Spherificator

## Authomatic Spheres

Dosifica automáticamente perlas de 4 tamaños distintos, 4, 6, 8 y 10 mm, produciendo más de 100 esferas por minuto. Este sistema permite elaborar caviar o perlas líquidas en gran cantidad con antelación, sin que endurezcan. Su sistema básicamente está diseñado para producir la esferificación inversa y poder tener en su mise en place una producción con gran rendimiento.

Completely automatic, Spherificator produces more than 100 spheres per minute, in four different diameters (4, 6, 8 and 10 mm). Prepare in advance huge quantity of imitation caviar for parties, corporate events and any sort of catering. Reverse spherification ensures the best yield needed by professionals.



¡Único en el mercado!  
Unique in the market!

20/0005  
Spherificator

- 4 mm
- 6 mm
- 8 mm
- 10 mm



¡Produce 2 Kg/hora!  
Produces up to 2 Kg/hour!



El ventilador interno garantiza el máximo rendimiento incluso con esferas pequeñas.  
The internal fan works even with small spheres



14K

20/2004  
Cuchara Lotus GOLD  
GOLD Lotus Spoon



Inox  
Stainless Steel

10 uds  
pcs  
20/0004  
Cuchara Lotus  
Lotus Spoon





30/0005  
Air Kit 2 \*

Ø 20 mm    Ø 17 mm    Ø 5 mm    Ø 3 mm



Tubos dispensadores  
Dispenser tubes

Agujas  
Needles

Spaghetti Kit

### Sujetasifón Whip Support

Aumenta el rendimiento un 25%, aprovechando al máximo el producto.

Increase the yield of the recipe up to 25%, taking the most advantage of your preparations.

30/0006  
Sujetasifón  
Whipper support



### Cargas sifón N2O N2O Whip Charges

30/0012

10 uds  
pcs

30/0012-B

360 uds  
pcs

8 g



30/0010  
Cargas Sifón CO2  
CO2 Whip Charges

10 uds  
pcs

## Air-Kit 3<sup>®</sup>

### Porta Boquilla Universal Universal Piping Tip

1 sola conexión para infinitas boquillas.  
1 unique adapter for infinite piping tips



Solo para boquillas de Ø 32 mm  
Only for Ø 32 mm piping tip

30/0009  
Air Kit 3 \*

Ø 32 mm



MODELO  
PATENTADO  
PATENTED  
MODEL

Boquillas no incluidas / Piping tips not included

## Turning-Kit®

Crea diferentes formas y tamaños de muelles  
Create spiral and springs in different sizes

La herramienta perfecta para crear diferentes formas y tamaños de muelle, con caramelo, chocolate u otras elaboraciones.

A perfect tool for creating different spiral shapes with caramel, chocolate or other preparations.



Este modelo no incluye el destornillador eléctrico: aconsejamos adquirir un destornillador recargable económico, pues no precisa un motor muy potente.

This model does not include electric screwdriver. We recommend purchasing economical rechargeable screwdriver, as the process does not require a very powerful motor.

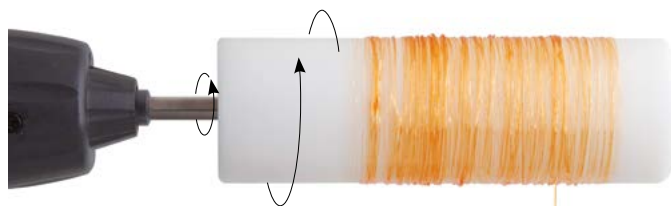

FÁCIL  
EASY

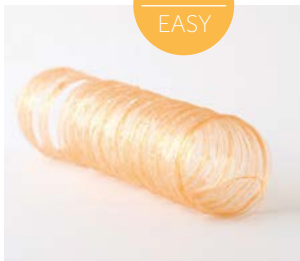

50/0004  
Turning-Kit

Cilindro Ø 4 cm  
Cilindro Ø 1.5 cm  
Cono de 1 cm hasta Ø 4 cm  
Llave Allen  
Punta de sujeción azúcar  
Eje giratorio intercambiable



Ø 4 cm cylinder  
Ø 1.5 cm cylinder  
Cone 1 cm to Ø 4 cm  
Hex Key  
Sugar Start Support  
Interchangeable rotating axis



RECETAS EN / RECIPES AT  
[www.100x100chef.com](http://www.100x100chef.com)

## SpaghettoKit®

Ideal para elaborar 5 Spaghetos de 1 m. de una vez  
Ideal kit for preparing 5 Spaghetto of 1 m. at once

- 01 5 tubos bridados de 1 m  
5 tubes of 1 m
- 02 1 biberón de relleno  
1 filler squeeze bottle
- 03 1 adaptador para sifón  
1 adapter for whipper

30/0001  
Spaghetto Kit Classic





# DekoSpray

Handheld airbrush

Easy-to-use handheld airbrush with rechargeable batteries. It offers great precision for decorating molds or small pieces and spraying on plates or glasses. It is perfect for stencil decoration.

Autonomía de 30 minutos de trabajo continuo.  
30 minutes of continuous work autonomy

Aerógrafo manual de fácil funcionamiento con baterías recargables. De gran precisión para decorar moldes o piezas pequeñas y pistolear sobre platos o vasos. Es perfecto para decoración con Stencils.

30/0095  
Deko Spray

Incluye 2 depositos con distintas capacidades (15 y 30 ml).  
Includes 2 tanks with different capacities (15 and 30 ml).



30/0096  
DKS Container  
Repuesto / Replacement



01

02

03

FACIL  
EASY

## Macarrón Kit®

Arpa de acero inoxidable ideal para la elaboración de tubos y cilindros de gelatina. Rápida producción e infinitas posibilidades de utilización.

Perfect tool for creating tubes and cylinders with flavored gelatines. Fast and easy production and many usages applications.

50/0017  
Macarrón Kit XL

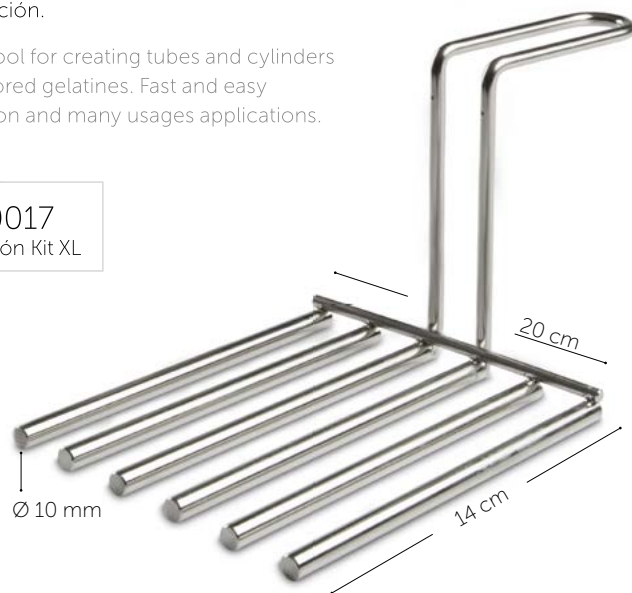

Técnicas y recetas de cocina molecular  
Molecular cuisine technique and recipes

FREE EXTRA CONTENT



Bol de acero inoxidable  
Cabezal giratorio macizo auto nivelable  
Stainless Steel Bowl  
Solid, auto-leveling spinning head



40/0011  
Cúpula transparente Super Cotton  
Super Cotton Clear Dome

Máquina profesional para algodón de azúcar  
Cotton Candy professional machine

SUPER SNACK COTTON es la máquina profesional de altas prestaciones. Una producción rápida y constante de algodón de azúcar blanco, con la posibilidad de añadir saborizantes y colorantes. Pensada para el uso comercial y larga duración. Fácil mantenimiento y limpieza.

Heavy-duty professional machine to produce high volumes of cotton candy. Add extra flavor and color in a rapid and steady production. Easy cleaning and maintenance.



Ø 50 cm



Ø 5, 7, 10, 13 cm

40/0012  
Molde empanadilla (4 tamaños)  
Dumpling Maker (4 sizes)



Empanadilla de frambuesas  
Raspberry small pasty



40/0010  
Super Cotton Candy Machine

230 V
50 Hz
1000W

40/1010  
Super Cotton Candy Machine [USA plugin]

110 V
60 Hz
1000W



Video curso Confi Kit  
por Martín Lippo  
Confi Kit video course  
by Martín Lippo

**FREE EXTRA CONTENT**



Pequeño bombo confitero  
Little coating pan

Para recubrir sin esfuerzo todo tipo de piezas con chocolate y garrapiñar los frutos secos o cereales con azúcar. Adaptable a cualquier modelo de robot Kitchen Aid o Kenwood.

For coating all sorts of nuts, truffles, and confections with tempered chocolate, sugar and other coatings. Also great for sugar coating almonds, dried fruits, cereals, turning them into succulent dragees.

Fits any model of Kenwood or Kitchen-Aid stand mixers.



**3 Kg**

Rampa incluida  
Ramp included

50/0002  
Confi-Kit Kitchen Aid

► Diseñado para todas las batidoras Kitchen Aid  
Designed to fit all Kitchen Aid stand mixers



50/0003  
Confi-Kit Kenwood NEW

► Diseñado para el nuevo modelo de Kenwood  
Designed to fit the last Kenwood model



50/0053  
Confi-Kit Kenwood OLD

► Diseñado para los antiguos modelos Kenwood  
Designed to fit the old Kenwood model



- Gelatinas • Garrapiñados saborizados • Crackins con Snack Cover • Frutos secos recapados • Grageas con chocolate saborizado • Frutas & vegetales recapados • Gelly Candies • Sugar-Coated Pills • Savoury Snacks • Coated Dried Fruit • Flavour-Coated Chocolates • Coated Fruits & Vegetables •





# Magic Drop

SPRAY EFECTO MERCURIO  
MERCURY EFFECT SPRAY

Aumenta la tensión superficial del plato impidiendo que los líquidos se esparzan, consiguiendo emplatados imposibles con salsas, coulis, jugos, aceites...

This spray increases the surface tension of the plate, preventing the liquids from spreading on it. So you can obtain impossible platings with sauces, coulis, juices, oils.



210/0053  
Magic Drop Spray 250 ml

Recomendado para platos esmaltados, porcelana, cerámicas y cristal

Recommended for enameled plates, porcelain, ceramics and glass

Resiste unos 10 lavados  
Resists up to 10 washes

con / with Magic Drop

# DJ

## Decor Food TURNTABLE

Soporte giratorio automático y regulable para decorar platos, pasteles, tartas, bandejas, vasitos y copas utilizando lápices alimentarios, brochas, salsas en botellines, mangas pasteleras. Perfecto para pintura de chocolate o aerografía. Puede cambiar el sentido del giro o utilizarlo de forma manual para trabajos de precisión.

This automatic spinning support offers easy way to decorate plates, cakes, tarts, trays, glasses and shots, by using food markers, brushes, bottled sauces, pastry bags. Perfect for painting with chocolate and airbrushing. It is possible to change spin direction or use it manually for works requiring more precision.

50/0051  
DJ Decor Food TurnTable

UP TO 8 Kg



MODELO COMPATIBLE | 230 V / 50 Hz  
COMPATIBLE MODEL | 110 V / 60 Hz

De 3 a 60 RPM  
From 3 to 60 RPM





Fabricadas completamente en acero inoxidable para un mayor control térmico y mayor higiene.  
Made entirely of stainless steel for enhanced thermal control and increased hygiene.

Funciones de extracción y limpieza automática.  
Extraction and automatic cleaning functions.



Agitadores que maximizan el volumen del helado (OVERRUN)  
Agitators that maximize ice cream volume (OVERRUN).



### UNA ICELAB PARA CADA NECESIDAD AN ICELAB FOR EVERY NEED

Ref.	Modelo Model	Capacidad Capacity	Medidas Measures	Mercado Market
30/3013	H-1	0,25 / 0,50 L	30 x 45 x 45,5 cm	Hogar Home
30/3015	H-2	0,7 / 1,4 L	35 x 50 x 57 cm	Restaurante - Lab Restaurant - Lab
30/3016	H-4	1,2 / 2,5 L	40 x 64 x 62 cm	Restaurante - Hotel Restaurant - Hotel
30/3017	H-6	2 / 4 L	42 x 60 x 70 cm	Hotel Hotel
30/3018	H-10	3 / 6,5 L	42 x 60 x 70 cm	Heladería Ice-cream shop



### MANTECADORA PROFESIONAL PROFESSIONAL ICE-CREAM MAKER

Obtenga helados cremosos, suaves, ligeros y homogéneos en tan sólo 10 minutos. ICELAB ofrece un proceso de elaboración controlado, manejo sencillo y de escaso mantenimiento. Una máquina robusta de reducidas dimensiones que le permitirá elaborar un helado de gran calidad sin necesidad de disponer de grandes conocimientos.

Get creamy, smooth, light, and homogeneous ice creams in just 10 minutes with ICELAB. It offers a controlled production process, easy handling, and low maintenance. This robust machine, despite its compact size, allows you to create high-quality ice cream without requiring extensive knowledge.

# SQUASHER

## Emulsionadora por presión Pressure homogenizer

Aplasta los productos extrayendo y homogeneizando el contenido. Utiliza una presión medida y exacta. Squasher repite las presiones cientos de veces por minuto. El líquido funciona como un disolvente, mientras recoge y se impregna con todo el sabor de los ingredientes.

No calienta el producto, no hay contacto con metal alguno evitando la oxidación, presiona sin extraer partículas amargas de algunas hojas, extrae aceites esenciales de los cítricos, emulsiona las partículas entre sí para obtener un sabor homogéneo y preservando la frescura de los aromas. Las partículas aromáticas se disuelven delicadamente en el líquido base: agua, alcohol o aceites.

Its plaques crush the products, extracting and homogenizing the content. Using a measured and exact pressure. Squasher repeats the pressure cycle hundreds of times per minute. The liquid works as a solvent, it collects and imbibes all the flavor of the ingredients.

Squasher does not heat the product, there is no contact with any metal avoiding oxidation. It presses just enough, but without extracting bitter particles from some leaves, extracts essential oils from citrus fruits, emulsifies the particles together to obtain a homogeneous flavor and preserving the freshness of the aromas. The aromatic particles are gently dissolved in the base liquid: water, alcohol or oils.

### SQUASHER

100/0200 230V · 50Hz	100/0201 110V · 60Hz
-------------------------	-------------------------



Recetas de cócteles  
con Squasher  
Cocktail recipes  
with Squasher



**FREE EXTRA CONTENT**



100/0203

Soporte para bolsas  
Bag Holder

Ø 8 cm Alt / Height: 25 cm  
Base: Ø 15 x 0.6 cm

Bolsas de envasado al vacío con filtro lateral interior de 100 µm. Ideales para preparaciones de mixología y ser empleados en la emulsionadora SQUASHER. Desde infusiones o caldos obtendrá un líquido limpio y clarificado sin residuos ni posos sin necesidad de colarlo. Capacidad útil 400 ml. No aptas para cocción.

Vacuum storage bags with 100 µm inner side filter. Ideal for the preparation of cocktails or mixology preparations and to be used in the SQUASHER homogenizer. Obtain a clean and clarified liquid without residues or grounds without the need to strain infusions and broths. Usable capacity 400 ml. Not suitable for cooking.

Además del uso en coctelería Squasher ofrece un gran recorrido en cocina por la intensidad del sabor en caldos en frío y caliente; café y té Cold Brew, infusiones de leche o nata para base de helados y cremas, elaboración à la minute de leches vegetales y horchatas, además como emulsionadora a presión y especialmente en el uso de grasas, pil-pil y elaboraciones con colágeno, holandesas y salsas con base grasa à la minute,...

Squasher destaca por su capacidad de emulsionado y de extracción del sabor, el respeto máximo del aroma, como recetas que incluyan cítricos (dulces o saladas), hierbas frescas (infusiones en frío o en caliente) y aromas florales (con mucha más presencia) pues en ninguno de ellos se le aprecia amargor.

100/0202  
Bolsas con filtro  
Filter Bags

50 uds  
pcs

30 x 19 cm

In addition to its use in cocktails, Squasher offers a wide range of applications in the kitchen due to its flavor intensity in hot and cold broths, coffee and cold brew tea, milk or cream infusions for ice cream and cream bases, à la minute preparation of vegetable milks and horchata, as well as a pressure emulsifier and especially in the use of fats, pil-pil and preparations with collagen, hollandaise and fat-based sauces à la minute.

Squasher stands out for its emulsifying and flavor extraction capacity, maximum respect for aroma, such as recipes including citrus fruits (sweet or savory), fresh herbs (hot or cold infusions) and floral aromas (with much more presence), as none of them show bitterness.



Caipirinha



Made with **SQUASHER**



## Centrífuga culinaria Culinary Centrifuge

Pensada para realizar trabajos muy precisos en cocina y coctelería, CentriCook separa los zumos de las fibras en suspensión y las concentra en la base, donde queda la esencia más pura del alimento con una textura sedosa y casi impalpable (la pomada). En la parte superior queda el zumo o jugo clarificado, muy útil en coctelería para obtener cócteles clarificados y sin partículas en flotación. Clarifique todo tipo de jugos, caldos o aguas vegetativas sin necesidad de utilizar pectinasas o espesantes ni aumentar la temperatura.

CentriCook acelera el proceso con respeto al uso de pectinasas o espesantes, sin calentar el producto. No acentúa la acidez y preserva de la oxidación. El producto final obtenido presenta un sabor más natural.

Designed for very precise work in cooking and cocktail making, CentriCook separates the juices from the suspended fibers and concentrates them at the base, where the purest essence of the food remains with a silky and almost impalpable texture (concentrated pulp). In the upper part remains the clarified juice, very useful in cocktails to obtain clarified cocktails without floating particles. Clarify all types of juices, broths, or vegetative waters without the need to use pectinases or thickeners or increase the temperature. CentriCook accelerates the process compared to the use of pectinases or thickeners, without heating the product. It does not accentuate acidity and preserves it from oxidation. The final product obtained has a more natural flavor.

### ANTES / BEFORE CENTRICOOK



### DESPUÉS / AFTER CENTRICOOK



## TAKE CLARIFICATION TO THE NEXT LEVEL



## CLARIFICA HASTA 3 LITROS EN 10 MINUTOS

Alcanza 4000 RPM en menos de 15 segundos,

## CLARIFIES UP TO 3 LITERS IN 10 MINUTES

It reaches 4000 RPM in less than 15 second,



**Fresa**  
Strawberry



**Agua de Fresa**  
Strawberry Water



**Pulpa pura de Fresa**  
Strawberry Pure Pulp



### CENTRICOOK

30/3000  
230V

30/3007  
110V

1 L. capacidad / capacity



Incluye 4 envases de 250 ml.  
Includes 4 containers of 250 ml.

### CENTRICOOK XL

30/3012  
230V

3 L. capacidad / capacity



Incluye 4 envases de 750 ml.  
Includes 4 containers of 750 ml.

12 uds  
pcs

30/3001  
Botellas CentriCook  
CentriCook Bottles

250 ml



4 uds  
pcs

30/3014  
Botellas CentriCook XL  
CentriCook XL Bottles

750 ml



# SLIMMER

## Plancha de presión mecánica Mechanical grill press

Inspirada en un snack callejero japonés, Slimmer ofrece resultados nunca vistos y expande las posibilidades de cualquier producto planchado.

Gracias al control preciso de la temperatura en sus dos placas de aluminio, y con una capacidad de presión de 2000 Kg/cm<sup>2</sup>, Slimmer es capaz de prensar cualquier ingrediente a un grosor de hasta 1 milímetro mientras lo cuece.

Proteínas, verduras, masas e incluso snacks dulces en un nuevo formato con apariencia inédita. En solamente dos minutos, ofrece un sorprendente snack fino, crujiente, con un atractivo único convirtiéndolo en un imprescindible para los más creativos.

Inspired by a Japanese street snack, Slimmer is a machine that offers unprecedented results and expands the possibilities of any pressed product.

With precise temperature control on its two aluminum plates and a pressure capacity of 2000 kg/cm<sup>2</sup>, Slimmer can press any ingredient to a thickness of up to 1 millimeter while cooking it.

Proteins, vegetables, doughs, and even sweet snacks take on a new format with an unprecedented appearance. In just two minutes, it delivers a surprising thin, crispy snack with a unique appeal, making it a must-have for the most creative individuals.

↓ ↓ ↓  
**2000 Kgs / cm<sup>2</sup>**  
**CAPACIDAD DE PRESIÓN**  
**PRESS CAPACITY**  
↑ ↑ ↑



**30/3008**  
Slimmer 220 V  
2400W 220V / 50 Hz

**30/3009**  
Slimmer 110 V  
2400W 110V / 60 Hz



**CONTROL PRECISO  
DE TEMPERATURA**

PRECISE TEMPERATURE CONTROL

**TEMPERATURA DE TRABAJO**

OPERATING TEMPERATURE RANGE

 **240°C**  
464°F



Disfrute del control de temperatura en la zona superior e inferior, permitiéndole ajustar de forma independiente cada parte.

Slimmer es una herramienta capaz de construir un concepto de negocio por sí sola. Diseñado con una medida de sobremesa, un peso práctico y de muy fácil manejo, es perfecto para cualquier tipo de proyecto gastronómico. Un nuevo camino para lo emprendedores más inquietos.

Enjoy temperature control over the upper and lower zones, allowing you to independently adjust each part.

Slimmer is a tool capable of crafting a business concept on its own. Designed with a compact size, convenient weight, and effortless handling, it's perfect for any gastronomic project. A new path for the most ambitious entrepreneurs.

**6** uds  
pcs  
**30/3019**  
Teflón Slimmer  
31 x 33 cm





# pacojet

Pacotizar® es un método único para transformar los preparados de alimentos ultracongelados frescos en texturas ultrafinas sin descongelar.

La Pacojet 4 destaca por sus numerosas características nuevas, que incluyen la opción de Pacotizar® ciertas recetas en solo 90 segundos. Una gran pantalla táctil ofrece una guía intuitiva al usuario, con una función de asistencia animada y un modo de detección de dispositivos inteligentes. La nueva Pacojet es excepcionalmente silenciosa y brinda resultados sobresalientes, garantizando una máxima productividad y cumpliendo los deseos de los usuarios.

Pacotizing® is a unique method for transforming fresh, ultra-frozen food preparations into ultra-fine textures without thawing.

The Pacojet 4 stands out with its numerous new features, including the option to Pacotize® certain recipes in just 90 seconds. It features a large touchscreen that provides intuitive user guidance with animated assistance and smart device detection mode. The new Pacojet is exceptionally quiet and delivers outstanding results, ensuring maximum productivity and fulfilling the desires of users.

30/5000

PacoJet 4 System

1500 W 220V

50 x 20 cm Alt / Height 36,5cm



Conoce más sobre PacoJet 4  
Learn more about PacoJet 4

PJ4 System incluye: Vaso sintético con tapa, Cuchilla PJ4, Vaso protector, Protector salpicaduras  
PJ4 System includes: Synthetic beaker with lid, PJ4 blade, Protective beaker, Spray guard

CONSULTAR DISPONIBILIDAD POR PAISES / CHECK AVAILABILITY FOR EACH COUNTRY





ACCESORIOS  
ACCESSORIES

**pacojet**



**30/5002**  
Pastillas de limpieza 60 uds.  
Cleaning tabs 60 pcs.



**30/5011**  
Cuchillas PJ4/PJ2 Plus  
PJ4/PJ2 Plus Blade



Vasos sintéticos Pacotizing con tapa  
Synthetic Pacotizing beakers with lid

**30/5010** 6 uds  
pcs

**30/5009** 12 uds  
pcs



**30/5019**  
Vaso protector PJ4 para sintético  
Protective beaker PJ4 for Synthetic



**30/5022**  
Raspador preliminar PJ4  
Preliminary scraper PJ4



**30/5005**  
Coupé Set PJ4



**30/5024**  
Kit Nitro PJ4



**30/5014**  
Vaso protector PJ4 para beakers de acero  
Protective beaker PJ4 for chrome steel

# OCOO

## PRO SYSTEM

Máquina de doble cocción y presión automática

**OCOO-PRO** cocina aplicando el principio de la doble ebullición, con temperatura y presión controladas para extraer el máximo sabor. Se obtienen extractos con un sabor intenso, aptos a ser utilizados como pre-elaboraciones y también como platos finalizados. Los aromas de la cocción se concentran en el interior de la olla y se preservan las cualidades organolépticas de los alimentos.

Automatic double pressure boiler

**OCOO-PRO** cooks applying the double boiling principle and controls temperature and pressure to extract the maximum flavor. Obtain extracts with an intense taste, suitable to be used as pre-elaborations and also finished dishes. OCOO keeps the aromas of the food locked inside the pot and preserves the organoleptic characteristics of the food.

Olla interior de germanio con vaporera para gran producción

Germanium inner cauldron with steamer for bigger production

Válvula doble de seguridad y presión Control de temperatura

Safety and pressure double valves Temperature control



—  —  
Instrucciones en  
User manual in:  
EN - SP - FR - IT

Detección del nivel de agua  
Water level detection



Coliflor fermentada  
Fermented cauliflower



Vinagreta de mango  
Mango vinaigrette



Almendras supertiernas  
Supersoft almonds



Consomé de mango  
Mango consommé



Queso fresco  
Fresh cheese



Video-recetas originales  
del restaurante Disfrutar  
Original video recipes  
from Disfrutar restaurant

**FREE EXTRA CONTENT**

*"Después del impacto de la cocción a baja temperatura en la cocina  
OCOO es sin duda la nueva revolución que marcará nuestra época"*

*"After the impact of low-temperature cooking in our trade,  
OCOO is undoubtedly the next revolution that will mark our era."*

¿Qué puedo hacer con OCOO-PRO?  
What can I do with OCOO-PRO?

- |  |                      |
|--|----------------------|
| Pre-elaborations<br>Elaboraciones              | Drinks<br>Bebidas    |
| Sauces and Syrups<br>Salsas y Jarabes          | Stews<br>Guisos      |
| Fermentations<br>Fermentados                   | Pastry<br>Pastelería |
| Slow Cooking<br>Largas Cocciones               | Dairy<br>Lácteos     |
| Color processes<br>Procesos de color           |                      |
| Curing and Aging<br>Envejecimiento y Curado    |                      |
| Low Temperature<br>Baja Temperatura            |                      |
| Extracts and Consommés<br>Extractos y Consomés |                      |



OCOO-PRO 230 V 60 Hz

30/0020 RE - Rojo / Red

30/0021 BR - Negro / Black

USA plugin

OCOO-PRO 110 V 50 Hz

30/1020 RE - Rojo / Red

Power Potencia 800 W

Pressure Presión 78.4 kpa

Recambios y accesorios disponibles en:  
Spare parts and accessories available on:  
[www.100x100chef.com](http://www.100x100chef.com)



Patata negra  
Black potato



Huevo al vapor  
Steamed egg

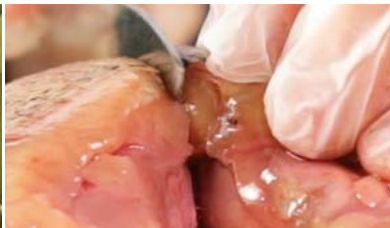

Pichón al vacío  
Sous vide squab pigeon



"Apio-vainilla" con gorgonzola  
Gorgonzola "celery-vainilla"



Sandía como tomate  
Watermelon as tomato



Nutrición saludable · Dieta macrobiótica · Superalimentos probióticos · Dieta Anti-Oxidación · Menú para aumentar su inmunidad  
Healthy Nutrition · Macrobiotic Diet · Probiotic Superfood · Anti-Oxidation Dietetics · Boost Immunity Menu

# Enzyme+

## Fermentador Automático Multifunción Multi-functional Smart Fermenter

Enzyme+ es la solución definitiva para la fermentación controlada, la esterilización y desinfección, los procesos de secado y la cocción a fuego lento.

Permite una distribución tridimensional del calor y mantiene la temperatura uniforme tanto en los bordes laterales como en la parte alta. Gracias a su aislamiento evita la pérdida de calor reduciendo así el consumo de energía. Equipada con cesta de acero inoxidable con 2 niveles para maximizar la producción.

Cada programa puede ajustarse en temperatura y tiempo, para obtener efectos de sabor variados y satisfacer múltiples requisitos.

Enzyme+ is the ultimate solution for Controlled Fermentation, Sterilization and Disinfection, Drying & Simmering Processes.

It makes possible the three-dimensional heating around and at the top, with uniform internal temperature. Highly insulated, it prevents heat loss and thus reduces energy consumption. Equipped with multi-layered stainless-steel cage, to maximize the production.

Every program can be set to meet different taste effects and different time requirements by changing temperature and time.



Ajo negro y cebolla  
Black garlic & Onion



Enzimas  
Enzyme



Vinagre de frutas  
Fruit vinegar



Cocción a fuego lento  
Simmer



Vino de arroz dulce  
Sweet rice wine

  
**CONTROL DE TEMPERATURA**  
TEMPERATURE CONTROL

  
**MANTIENE EL CALOR**  
KEEP WARM

  
**DESHIDRATA**  
DEHYDRATE

  
**SISTEMA DESINFECTANTE**  
DISINFECTION SYSTEM

**PROGRAMAS PRE-CONFIGURADOS:**  
PRE-SET PROGRAMS:

Ajo Garlic	Vino dulce de arroz Sweet Rice Wine
Ajo Solo Solo Garlic	Encurtidos Pickles & Sourdough
Yogur Yogurt	Masa madre Drying & Heat
Natto Natto	Secado Preservation
Enzima Enzyme	Conservación por calor Simmer
Vinagre de frutas Fruit Vinegar	Desinfección a fuego lento Disinfection
Vino de frutas Fruit Wine	

30/4000  
Enzyme+ 220 - 240 V / 50Hz

29 Ø Alt / Height: 27 cm  
90 - 110 W

30/4001  
Enzyme+ 110 V / 60 Hz

29 Ø Alt / Height: 27 cm  
90 - 110 W

**BAJO CONSUMO**  
LOW CONSUME

**Capacity 5 L**



**LIBRE DE BPA**  
BPA-FREE

**MANTIENE EL CALOR 288 HORAS**  
288 HOURS KEEP WARM

**REGULADOR CON SOFISTICADA TECNOLOGÍA MICRO-COM**  
FUZZY LOGIC MICRO-COM CONTROLLER







## Conchadora basculante de sobremesa

Por fin una cochadora compacta y versátil que trabaja hasta 3 Kg de producto a la vez.

Twin Stones es ideal para preparaciones tanto dulces como saladas, generando texturas y emulsiones perfectas e impalpables.

Equipada con motor de alto rendimiento, su doble pala y rodillos de granito reducen el tiempo de refinado, evitando sobrecalentarlos, mientras que su doble deflector dirige el fluido bajo las piedras. Se crea así una mejor aireación o conchado. Además, el bol es inclinable, para facilitar la retirada del producto.



## Table Top Wet Grinder

Finally a compact and versatile wet grinder can to works with 3 Kg of product at a time.

Twin Stones is ideal for both sweet and savoury preparations, it produces impalpable textures and emulsions.

Equipped with a high-performance motor, reinforced double-bladed shaft, wide rotating stones made of granite. Twin Stones refines the ingredients without overheating them. Its double-baffle directs the fluid under the rolling stones creating better conching and making it easier to remove the product.



Recetas y aplicaciones de Twin Stones  
Twin Stones recipes and applications

[FREE EXTRA CONTENT](#)

## TWIN STONES

30/0053  
230V · 50Hz

30/0054  
110V · 60Hz

Ø base 35 cm  
Altura / Height: 40 cm

**130 RPM** | motor de alto rendimiento  
high performance motor



2 piedras de granito actúan como un molino...  
¡para crear emulsiones y texturas perfectas!

2 granite stones act like a mill...  
to create perfect emulsions and textures!



Moler / Grind



Amasar / Knead



Rallar / Grate



Emulsionar / Emulsify

## bean-to-bar taste-to-bar

Gran capacidad  
Big Capacity

**3Kg** con producto cremoso o líquido  
with creamy or liquid products

**2Kg** con producto espeso  
with thick products

Ø 25 cm

Bol en inox con base en granito  
Stainless steel drum with granite base



30/0086

Soporte INOX Twin Stones  
Twin Stones Stainless Steel Support

Soporte de acero inoxidable que aumenta la presión del conchado, acelera el proceso y evita el calentamiento del producto. Saque el máximo rendimiento con este accesorio.

Stainless steel support that increases the conching pressure, speeds up the process and prevents the product from heating up. Get the most out with this accessory.





**Premier**<sup>®</sup>

*Chocolate Refiner*

21,5cm



36 cm

15 cm

### REFINADORA DE CHOCOLATE

Pequeña pero potente, esta refinadora de bajo impacto permite conservar al máximo el valor nutritivo y organoléptico, al tiempo que preserva la vida útil del producto ya que se realiza a baja temperatura.

Con una capacidad de 2,5 kg, dispone de un robusto motor que está diseñado para soportar trabajo continuado.

Las dos espátulas laterales redirigen la pasta hacia el centro donde los rodillos de granito natural aceleran el proceso de conchado, además de airear la mezcla durante su refinamiento.

Compacta en tamaño pero capaz de realizar grandes tareas.

### CHOCOLATE REFINER

Small but powerful, this low-impact refiner allows for maximum preservation of nutritional and sensory value while extending the product's shelf life by operating at low temperatures.

With a capacity of 2.5 kg, it features a sturdy motor designed to withstand continuous work.

The two side scrapers redirect the paste towards the center, where natural granite rollers accelerate the conching process and aerate the mixture during refining.

Compact in size yet capable of accomplishing significant tasks.

**120 - 140 Rpm**

**Refina a menos de 20 micras**  
Refine to less than 20 microns

**MOTOR ROBUSTO**  
**72 h de funcionamiento seguro**  
DURABLE MOTOR  
72 h continuous operation

**Pequeño y compacto**  
Small and compact

**No sobrecalienta la elaboración**  
Doesn't transfer heat to product

**Fácil desmontaje y limpieza**  
Easy disassembly and cleaning

### ELABORA CHOCOLATE Y PASTAS PURAS DE FRUTOS SECOS DESDE CERO

MAKE CHOCOLATE AND NUT BUTTERS FROM SCRATCH



*Cold Refiner*

30/0094  
Refinadora chocolate  
Chocolate refiner

220V / 50-60 Hz / 200W





## SODA CAN SEALER "Bronson"

Sella en apenas 5 segundos por lata de forma automática, y tan solo pulsando un botón, produciendo más 400 latas por hora. Puede sellar latas de Aluminio y Pet 250 y 330 ml siempre que los diámetros sean los apropiados para las bases suministradas.  
Con la máquina se proporcionan 2 bases diferentes para los diferentes tamaños de latas.

Seals in just 5 seconds per can automatically, and just by pressing a button. Producing more than 400 cans per hour. It can seal 250 and 330 ml Aluminum and Pet cans as long as the diameters are appropriate for the supplied bases.  
The machine is supplied with 2 different bases for different can sizes.

100/1046  
Cierralatas automático  
Automatic Can Sealer

220V 50Hz CE or UK Plug

100/1047  
Cierralatas automático  
Automatic Can Sealer

110V 60Hz USA Plug



100/1045  
Lata Soda PET 330 ml  
Soda Can PET 330 ml

100 uds  
pcs

100/1044  
Lata Soda PET 250 ml  
Soda Can PET 250 ml

100 uds  
pcs

Fabricado en PET tipo "Crystal" por su claridad semejante a la del vidrio. No contiene BPA. Resistentes entre -20 a 50 °C, siempre deben llenarse en frío.

Made of PET called "Crystal" type because of its glass-like clarity. It does not contain BPA. Resistant from -20 to 50 °C, they should always be filled cold.



PERSONALIZABLES  
CUSTOMIZABLE



# DryCook

## Deshidratador profesional Professional Dehydrator

Deshidratadores para uso profesional en cocina y pastelería. Controla la temperatura con una precisión de 0,5 grados desde 35 a 80°C. Deshidratación regular a gran escala con ventilación horizontal. Las bandejas regulables en altura permiten fermentar lácticos como yogurt, desecar todo tipo de frutas vegetales, especias para decorar o elaborar polvos, trabajos con azúcar, claras, Oblate®, secado de carnes y pescados, elaboración de hojas enteras, o bien pequeñas formas realizadas con Krokanters®. Al deshidratar por encima de los 75°C también permite trabajar con ovo-productos. Construido para durar, tiene unos motores muy silenciosos de gran rendimiento. Luz interior para ver el producto sin necesidad de abrir la puerta.

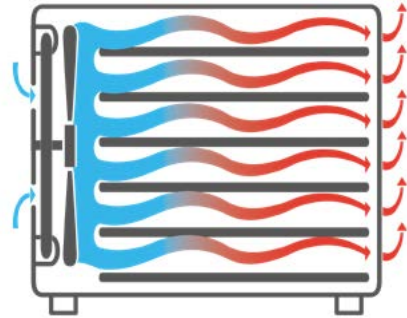

High performance dehydrators for professional kitchens and pastry shops. Control the temperature with a 0,5 degrees precision of from 35 to 80°C (95 °F to 176 °F). Regular dehydration with large-scale production and horizontal ventilation. Height adjustable trays allow you to ferment dairy products like a yogurt, dry all kinds of fruits and vegetables, spices for decorating or making powders, work with sugar, egg whites, Oblate®, drying of meat and fish, processing of whole leaves, or small shapes made with Krokanters®. Dehydration above 75°C (167 °F) also allows you to work with ovo-products. Built to last, have high-performance and very quiet motors. Interior light to see the product without opening the door.

## THE ULTIMATE GENERATION IN DEHYDRATION TECHNOLOGY FOR CHEFS



Acero Inoxidable  
Stainless-Steel

Controles digitales  
Digital display



## DIGITAL CONTROL



Exactitud y precisión  
Accuracy and precision

Fácil limpieza y mantenimiento  
Easy cleaning and maintenance

70/1000  
DRYCOOK

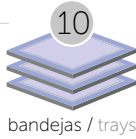

220V / 50 -60Hz 800 WATTS  
1 Ventilador / 1 Fan  
10 Bandejas / 10 Trays (30 x 28 cm)  
0.84 m<sup>2</sup> Producción / Production



70/1001  
DRYCOOK XL

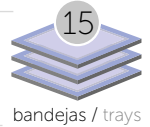

220V / 50 -60Hz 1500 WATTS  
2 Ventilador / 2 Fan  
15 Bandejas / 15 Trays (40 x 38 cm)  
2.28 m<sup>2</sup> Producción / Production

Equipado con pies antideslizantes para apilar dos máquinas o ruedas con freno para moverlas fácilmente.

Equipped with anti-slip feet for stacking two machines or castors with brakes for easy moving.

## Accesorios y complementos Accessories & Complements



Hojas de Teflón laminada de 150 µm y antiadherente por ambas caras. Garantiza más de 500 usos.

150 µm laminated Teflon sheets, non-stick on both sides. Guaranteed for over 500 uses.



Rejilla de silicona que facilita el paso de aire sin que vuelen por la acción del secado. Perfecto para productos delicados como flores y Obulatos.

Silicone grid that allows air to pass through without items flying due to drying action. Perfect for delicate products such as flowers and Obulatos.



Rejilla de recambio de acero inoxidable. Resistente, reutilizable, fácil de limpiar y aptas para el contacto alimentario.

Stainless steel replacement grid. Resistant, reusable, easy to clean, and food-safe.

**70/1002**  
Hoja de teflón DryCook XS  
Non-stick Teflon Sheet XS

5 uds  
pcs

**70/1004**  
Hoja rejilla DryCook XS  
DryCook grid sheet XS

5 uds  
pcs

**70/1006**  
Rejilla acero inoxidable XS  
Stainless-steel grid

Medidas / Measurements 30 x 28 cm For: 70/1000 DryCook, 70/0012 Excalibur 2400

**70/1003**  
Hoja de teflón DryCook XL  
Non-stick Teflon Sheet

5 uds  
pcs

**70/1005**  
Hoja rejilla DryCook XL  
DryCook grid sheet XL

5 uds  
pcs

**70/1007**  
Rejilla acero inoxidable XL  
Stainless-steel grid

Medidas / Measurements 40 x 38 cm For: 70/1001 DryCook XL

Compatible con Plantillas Krokanters, p.398  
Use with Krokanters Stencil, p.398

**Excalibur**  
 AMERICA'S BEST DEHYDRATOR  
 PROFESSIONAL SERIES

70/0004  
 Excalibur 4926 TM

Termostato + temporizador  
 Adjustable thermostat + timer



Instrucciones en  
 User manual in:  
 EN - SP

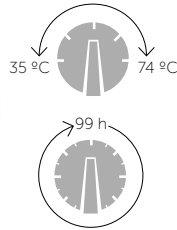

Excalibur 4926 TM & 4900

Motor: 220 V / 50 Hz  
 Ventilador: 18 cm / 600 Watts  
 Bandeja: 35 x 35 cm  
 Sup. secado útil: 1 m<sup>2</sup>  
 Fan: 18 cm / 600 Watts  
 Tray: 35 x 35 cm  
 Drying area: 1 m<sup>2</sup>

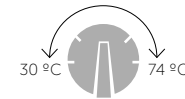

70/0003  
 Excalibur 4900

Regulador de temperatura  
 Adjustable thermostat



Accesorio / Spare Part:

70/0018  
 Puerta transparente Excalibur®  
 Excalibur® transparent door

Para serie / Fits series:  
 Excalibur 4900 / 4926T



bandejas / trays

Incluye 9 bandejas  
 y 9 rejillas.

No incluye  
 silicona ni Teflón

Includes 9 trays  
 and 9 grids.

Silicones and Teflon  
 not included

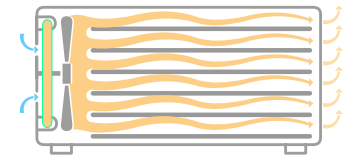

**Parallexx® Drying System**

**Excalibur**  
 AMERICA'S BEST DEHYDRATOR  
 PROFESSIONAL SERIES

**Excalibur PRO EXC10EL**

Motor: 230 V / 50 Hz  
 Ventilador: 18 cm / 600 W  
 Sup. secado: 1.4 m<sup>2</sup>  
 Bandeja: 38 x 38 cm  
 Fan: 18 cm / 600 W  
 Drying Sur. 1.4 m<sup>2</sup>  
 Tray: 38 x 38 cm



Instrucciones en  
 User manual in:  
 EN - SP - FR



70/0001  
 Excalibur PRO EXC10EL

bandejas de acero inoxidable  
 stainless steel trays

**EXTREME PRECISION  
 DIGITAL CONTROLLER**

2 ciclos de tiempo con diferentes temperaturas  
 2 zones 2 times/2 temperatures 99 hour timer

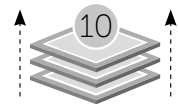

bandejas / trays  
 Parallexx® Drying System

**Excalibur**  
 AMERICA'S BEST DEHYDRATOR

**SMALL SERIES**

70/0012  
 Excalibur 4400



Regulador de temperatura  
 Adjustable thermostat

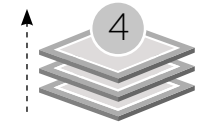

4 bandejas / 4 support trays  
 4 rejillas / 4 net trays

**Excalibur 2400**

Motor: 230 V / 50 Hz  
 Potencia: 235 W  
 Bandeja: 30 x 30 cm  
 Power: 235 W  
 Tray: 30 x 30 cm



70/1002  
 Hoja de teflón antiadherente  
 Non-stick Teflon Sheet

5 uds  
 pcs

Medidas / Measurements 30 x 30 cm



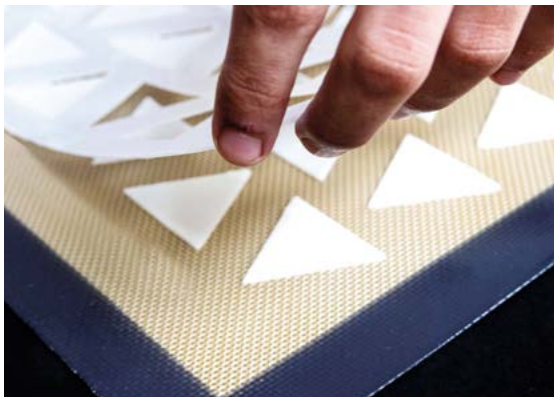

Compatible con Plantillas Krokanters, p.398  
Use with Krokanters Stencil, p. 398



Para serie / Fits series:  
4900 & 4926T

**70/0010**  
Bandeja soporte (recambio)  
Support tray (spare part)

**70/0011**  
Rejilla (recambio)  
Net tray (spare part)

**70/0051**  
Hoja de silicona pura  
Silicone sheet

**70/0039**  
Hoja de teflón antiadherente  
Non-stick Teflon Sheet

Medidas / Measurements 35,5 x 35,5 cm

#### Conserve:

- Liofilizados
- Trabajos de azúcar
- Aditivos
- Deshidratados
- Crujientes

#### Preserve:

- Lyophilized food
- Sugar crafts
- Additives
- Dehydrated ingredients
- Crispy and crunchy

Consiga un bajísimo grado de humedad ambiental para una mejor conservación del producto.

Designed to achieve an extremely low degree of relative humidity for a better conservation of the product.

5 uds  
pcs

5 uds  
pcs



**70/0041**  
Dry Food Box

31 L

230 V / 110 V  
50 x 40 cm  
Altura / Height: 27 cm

### Dry Food Box

Contenedor plástico hermético apilable con deshumidificador eléctrico a 12V. Bajísimo consumo. Regulable en 4 diferentes grados de humedad relativa 55 / 45 / 35 / 25%.

Stackable hermetic plastic container equipped with a 12V electric dehumidifier extremely. Low consumption. Adjustable to 4 different levels of relative humidity 55 / 45 / 35 / 25%.







## SLOW JUICERS TECHNOLOGY

Fácil limpieza  
Easy cleaning



Botón de seguridad  
Safety switch

Cepillo rotatorio  
Rotating brush



Salida zumo  
Juice outlet

Motor de baja velocidad  
Silencioso y duradero.



Low Speed AC Motor  
Quiet and stronger.

Pieles de 20 tomates cherry  
Amount of leftovers from 20 cherry tomatoes

Textura desligada  
Separate texture



Exprimidora tradicional  
Traditional juicer

+ 30%

Textura homogénea  
Homogeneous texture



Exprimidora Omega  
Omega slow juicer



Como usar las exprimidoras en gastronomía  
Inspirations for juicers applications in gastronomy

**FREE EXTRA CONTENT**

50/0008  
Exprimidora VRT 452 HDS  
Juicer

80 RPM

CLASSIC

**Omega  
Low Speed  
Technology  
System (LSTS)**





**50/0010**  
Exprimidora Superlenta  
Low Speed Juicer

**SUPERLENTA**

43 RPM

MANTIENE LAS ENZIMAS INTACTAS  
KEEPS INTACT HEALTHY ENZYMES

REDUCE LA FRICCIÓN Y EL CALOR  
REDUCES HEAT BUILDUP

SEPARACIÓN DE LA PULPA Y ZUMO  
DIVIDES PULP FROM JUICE

RETRASA EL PROCESO DE OXIDACIÓN  
DELAYS THE OXIDATION PROCESS

DOBLE SISTEMA DE FILTRAJE  
DOUBLE FILTERING SYSTEM

Omega VSJ843RS Juicer  
VRT 402HDS Juicer

Peso / Weight: 5 kg  
Altura / Height: 40 cm  
Voltage: 230 V / 50-60 Hz



8228 Nutrition Center Juicer

Peso / Weight: 9.7 kg

Dimensiones / Size: 16.5 x 37 cm  
Altura / Height: 40 cm

Voltage: 230 V / 50-60 Hz

EXTRAE ZUMO  
EXTRACTS JUICE

PICA  
MINCES

MUELE  
GRINDS

EXTRUDA PASTA  
EXTRUDES PASTA

HACE LECHE DE SOJA  
MAKES SOY MILK

MANTEQUILLA DE CACAHUETES  
NUT BUTTER

POSTRES HELADOS  
FROZEN DESSERT MAKER

DURADERA  
DURABLE

VERSÁTIL  
VERSATILE

POTENTE  
POWERFUL

SIMPLE  
SIMPLE

**SPECIAL FOR PULP**

**50/0035**  
Extractor de jugos  
Masticating juicer



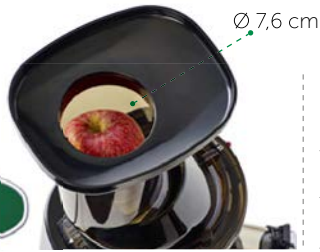

Omega Megamouth MMV700S

Peso / Weight: 5 kg

Altura / Height: 47 cm

Voltage: 230 V / 50-60 Hz

### SPECIAL SMOOTHIES

- MANZANAS** APPLES
- NARANJAS** ORANGES
- PEPINOS** CUCUMBERS
- KIWI** KIWI
- TOMATES** TOMATOES
- PERAS** PEARS

Sistema AUTO-CLEANING durante la producción de jugo, para aumentar la eficiencia.

The AUTO-CLEANING system during the juicing process increases the performance.



50/0016

Omega Megamouth MMV700S  
Slow Juicer

60 RPM

INTRODUZCA EL FRUTO ENTERO  
PUT IN THE WHOLE FRUIT

AHORRE TIEMPO DE PREPARACIÓN  
SAVE TIME DURING PREPARATION

ZUMOS SIN OXIDACIÓN  
HASTA 72 HORAS  
JUICES FREE FROM  
OXIDATION UP TO 72H

Blender Omega 3HP 442S

Peso / Weight: 3.4 kg

Dimensiones / Size: 20 x 23 cm

Altura / Height: 51 cm

Voltage: 230-240V / 50-60Hz

1500 Watts

### POWER BLENDER

50/0009

Batidora Blender Omega 3HP 442S  
Blender Omega 3HP 442S

VASO DE 2L DE  
CO-POLYESTER  
SUPER-RESISTENTE  
HIGH RESISTANCE 2-L GLASS  
MADE FROM CO-POLYESTER

CUCHILLAS ESPECIALES  
DE ACERO  
STAINLESS STEEL CROSS KNIFE

CONTROLES DE VELOCIDAD  
POWER CONTROLS



50/0012

Vaso de recambio con tapa  
Cup and Lid Replacement

Trabaje con un segundo vaso  
Work with two cups



# claribag

## Bolsas de filtrado Filter bags

Estameñas fabricadas 100% de poliamida, aptas para uso alimentario. Sedosas y maleables, no tienen costuras visibles, bordes de algodón o refuerzos de tela, lo que garantiza que siempre estén listas para volver a ser utilizadas. 9 bolsas de diferentes tamaños, equipadas con un aro de acero inoxidable para facilitar su llenado, asas para colgarlas y una etiqueta que identifica el modelo y el nivel de filtrado. Resistentes hasta 150°C. Ahorra esfuerzo y aprovecha al máximo las materias primas.

Muslin bags made from 100% polyamide, suitable for food use. Silky and pliable, they have no visible seams, cotton edges, or fabric reinforcements, ensuring they are always ready to be reused.

9 bags in different sizes, equipped with a stainless steel ring for easy filling, handles for hanging, and a label that identifies the model and filtration level. They can withstand temperatures up to 150°C.

Saves effort and maximizes the use of raw materials.



30/2005  
Conik 100 µ

6 L

Ø 29 X 29 cm

Para coladores cónicos  
For conical strainers



30/2007

OCOO Bag 100 µ

8 L

Ø 20 X 24 cm

Especial OCOO-PRO: elabore caldos e infusiones clarificadas extrayendo todavía mucho más.

Special OCOO-PRO: making broths and clarified infusions, extracting even more.



A

30/2004 Mini 100 µ  
Ø 10 x 23 cm 2 L

B

30/2008 Mini 50 µ  
Ø 10 x 23 cm 2 L

C

30/2002 Sauce 100 µ  
Ø 18 x 45 cm 8 L

D

30/2001 Sauce 250 µ  
Ø 18 x 45 cm 8 L

E

30/2003 Juice 100 µ  
Ø 15 x 32 cm 4 L

F

30/2000 Consommé 250 µ  
Ø 36 x 56 cm 52 L

G

30/2006 Long 100 µ  
Ø 18 x 82 cm 15 L

B

**Nuevo formato Mini 50 µ especial clarificados extremos.**  
**New Mini 50 µ format, specially designed for extreme clarifications.**



## TORCHETTO

### Prensa de 5 Litros 5-Liter Press

Prensa de tornillo para la extracción de zumos por presión de fruta madura como uvas, moras, melocotones, ciruelas...

En cocina es interesante su uso como prensa para extraer aguas vegetativas de pimientos asados, cebolla asadas, etc. o para una 2ª extracción de jugos una vez pasados previamente por el chino.

Cuenta con cesta de acero inoxidable y base antideslizante tipo ventosa.

Screw press for extracting juice by applying pressure to ripe fruits such as grapes, blackberries, peaches, plums...

In the kitchen, it's useful for pressing roasted peppers, roasted onions, etc., to extract vegetable waters, or for a second juice extraction after straining through a sieve.

Features a stainless steel basket and a non-slip suction cup base.

100/0204

Torchetto

5 L



72 - TOOL CONCEPTS

## Linterna de luz negra

## Black Light lantern

Ideal para detectar espinas o cáscaras de marisco dentro de farsas o picadillos. Las cáscaras de marisco y espinas de pescado contienen elementos fluorescentes que la linterna de luz negra resalta y permiten ser detectados en ambientes de cierta oscuridad.

Ideal for detecting spines or shells of shellfish in farces or hash. Shells of fish and fish bones contain fluorescent elements that will glow in the dark thanks to this light, permitting you to take them off easily.

¡Elaboraciones de pescado y marisco IMPECABLES!  
PERFECT preparation of fish and seafood!

30/0007  
Luz negra linterna  
Black light lantern

16 x 6 cm  
Altura / Height: 2 cm





## BRULEE

Soplete de cocina profesional  
Professional Culinary Torch

Cabezal de soplete profesional compatible con todas las botellas de gas azul desechables. Seguro, preciso y regulable con una sola mano, trabaja inclinado sin perder potencia ni precisión.

Professional torch head compatible with all disposable blue gas canisters. Safe, precise, and adjustable with one hand, it works at an angle without losing power or accuracy.

 Firepower  
1300°C

30/0004

Soplete de cocina profesional  
Professional Culinary Torch

## BRULEE MAX

Soplete de cocina de doble uso  
Double-use culinary torch

La llama concentrada tiene mayor poder calorífico que los sopletes comunes de cocina permitiendo sellar proteínas, marcar piezas grandes, complementar cocciones unilaterales, acelerar encendidos de carbón... La campana difusora expande la superficie de cocción y ofrece un calor regular y consistente, evitando el sabor derivado de sopletear los alimentos.

Con Brulee Max tendremos precisión y sabor en cada plato!

The concentrated flame has a higher heat output than regular kitchen torches, allowing for the searing of proteins, marking large pieces, enhancing one-sided cooking, and accelerating charcoal ignition... The diffuser bell expands the cooking surface and provides even and consistent heat, preventing the flavor derived from torching the food.

The diffuser bell expands the cooking surface and provides even and consistent heat, preventing the flavor derived from torching the food.

With Brulee Max, we'll have precision and flavor in every dish!



 Firepower  
1300°C - 1980°C

30/0200

Brulee Max

15 x 7 cm

Alt / Height: 31 cm

30/0201

Rejillas recambio Brulee Max  
Brulee Max Screens

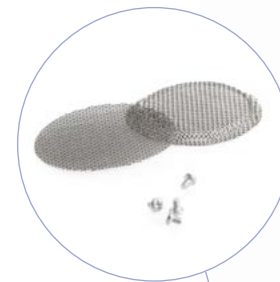

Base de seguridad anticaída  
Anti-fall and safety base



MAP-PRO



PROPANE

## TROLLEYS

Explore nuestra exclusiva línea de carros de servicio, diseñados meticulosamente para brindar experiencias y espectáculo frente al cliente.

Explore our exceptional range of service carts, meticulously crafted to deliver unforgettable experiences and captivating performances to your valued customers.

Fabricados en Solid Surface presentan:

- **Máxima Dureza**
- **Resistencia a la abrasión, no amarillean**
- **Impermeables y de fácil limpieza**

Manufactured in Solid Surface they have:

- **Maximum hardness**
- **Abrasion resistance, no yellowing**
- **Waterproof and easy to clean.**

Personalice su Trolley con logo, iluminación y colores corporativos.

Customize your Trolley with your logo, customized lighting, and corporate colors.

100/0402  
Trolley Gin&Tonic\*

26 x 60 cm  
Alt / Height: 105 cm

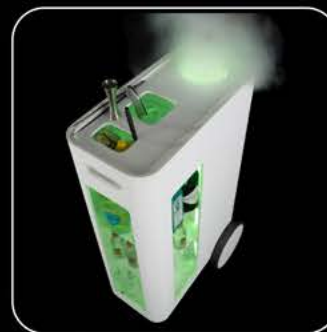

- Enfriador de copas -85°C integrado con CO<sup>2</sup>
- Cubitera
- Especiero
- Espacio para residuos
- Glass cooler -85°C integrated with CO<sup>2</sup>
- Ice bucket
- Spice tray
- Waste disposal area



- Capacidad para:
- 8 copas
  - 6 botellas
  - 8 tónicas

- Capacity for:
- 8 glasses
  - 6 Gin bottles
  - 8 Tonic water



- Luces led de distintos colores
- Mando a distancia
- Batería propia
- LED lights of different colors
- Remote control
- Own battery

\*No incluye botella CO<sup>2</sup>.  
\*CO<sup>2</sup> cylinder are not included.

100/0401  
Trolley Jabugo Premium

26 x 60 cm  
Alt / Height: 105 cm



El Trolley multifuncional  
The multi-functional trolley

100/0403  
Trolley Gueridon

26 x 60 cm  
Alt / Height: 105 cm



- Bandeja extraíble
- Pull-out tray



- Gran espacio de almacenaje
- Large storage space



Personalice su Trolley con logo, iluminación y colores corporativos.

Customize your Trolley with your logo, customized lighting, and corporate colors.





## Precision

Higiene y medición

Hygiene and measurement





### 130/0002

Balanza de alta precisión 0.005 g  
High Precision Scale 0.005 g

Ideal para un uso continuo. Pesa gramos, libras y quilates. Cálcula porcentajes y cuentapiezas, paravientos incluido, salida de datos en USB y RS-232-C para impresoras. Puede conectarse a la red eléctrica gracias a su batería recargable. Mueble de acero, y ABS con plato de acero inoxidable, rapidez en la puesta en marcha y estabilización.

Ideal for constant use, both with battery or plugged. Stainless steel chassis, and ABS with stainless steel plate, quick start and stabilization. Can weight: grams, pounds and carats. Piece counting function and percentage mode, wind protection included, USB data output and RS-232-C printer.

LCD display

Tara / Net tare

Pilas recargable / Rechargeable batteries

Precision: max: 150 g / min: 0,005 g



### 130/0001

Balanza de precisión 0.01 g  
Precision Scale 0.01 g

Ideal para el pesaje cotidiano de ingredientes que requieren muy poca cantidad y alta precisión. Estabilizantes para helados, azúcares, sal, trufa, agar-agar, especias. Pequeña, extraplana, fácil de usar, alta resistencia a los golpes debido a su caja cierre. Resistente a la caída de líquidos, rapidez en la puesta en marcha y estabilización.

Weight ingredients that require a very small amount and high accuracy. Ice cream stabilizers, sugar, salt, truffle, agar-agar, spices, etc.. Small, slim and easy to use, high shock resistance due to its closed box design. Liquid resistant, stable starting quickly.

LCD display

Tara / Net tare

Pilas / Batteries (4 x 1,5 tipo R03)

Precision: max: 100 g / min: 0,01 g



### 130/0003

Medidor digital de PH  
PH digital controller

Phimetro de bolsillo. Mide la acidez o alcalinidad de líquidos. Indispensable para los procesos de gelificación o esferificación. Sensor de temperatura. Totalmente estanco, incluso cuando cae en el agua flota y puede funcionar si está completamente sumergido.

Pocket pH meter. It measures the acidity or alkalinity of liquids. Essential in the process of gelification or spherification. Temperature sensor. Waterproof, it floats in water. Can work completely submerged.

PH: 0.00~14.00pH

Precisión / Accuracy:  $\pm 0.05$ pH

Resolución / Resolution: pH 0.01pH

Temp.: 0~60 °C



### 130/0004

Medidor digital de salinidad y PH  
Digital salinity and PH controller

Mida y domine el punto de sal de los alimentos en establecimientos, restaurantes, hospitales, escuelas, caterings o industria de la alimentación como queserías.

Accurately measure and control the salt in foods served in your company, restaurant, hospital, school, catering or food industry like cheese factories.

PH: -2.00~16.00pH

Precisión / Accuracy:  $\pm 0.01$ pH

Temp.: 0~60 °C

Salinidad / Salinity: 0.0 – 99.9 ppm 100 – 999 ppm 1–10 ppt

Baterías incluidas / Batteries included



Punta ultrafina para dosificación muy precisa  
Extra-thin tip for accurate use

### Botellín precisión Squeeze bottle

130/0011 50 ml 50 uds pcs

130/0012 150 ml 10 uds pcs

130/0013 300 ml



### Micro botellines

Micro squeeze bottle

130/0023 50 ml 20 uds pcs

130/0024 100 ml

Punta con aguja para trabajos de precisión

Needle tip for precision work





**DRACULA**  
Rollo papel absorbente  
Food pad roll

Papel plastificado y perforado con base de celulosa natural altamente absorbente. Su capa plástica aísla el alimento de la humedad y la celulosa retiene los jugos. Colocar en el fondo de los envases donde conservamos los pescados, mariscos o carnes crudas, quesos, frutas delicadas, ensaladas, flores, etc. obtendrá un producto de mejor calidad alargando su conservación considerablemente. La celulosa además regula la humedad del envase alargando la vida del alimento. Neveras libres de olores y contaminación cruzada.

CONSERVACIÓN ÓPTIMA  
GRANDES PRODUCCIONES  
ALIMENTOS MÁS FRESCOS POR MÁS TIEMPO

OPTIMUM PRESERVATION  
LARGE VOLUME PRODUCTION  
FRESHER FOOD FOR A LONGER TIME

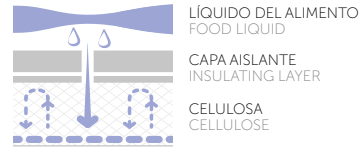

El líquido absorbido no toca el producto  
Liquid is absorbed and cannot touch the food

60 M

80/0041  
DRACULA  
Rollo papel absorbente  
Food pad roll

22 cm

Laminated micro perforated food pad, made with highly absorbent natural cellulose fibers. The upper layer isolates the food from moisture, while the cellulose fibers trap juices or liquids, increasing the shelf life of the produce. Optimal to stock fish, seafood shells, cheese, fruits, salad and flowers preserving their fragile aromas. This product prevents cross-contamination in the fridge.

Termómetro corporal digital con infrarrojos

Mide la temperatura corporal a distancia en 1 segundo. Precisión y rapidez sin necesidad de contacto. Pantalla LCD con retroiluminación, permite el uso en la oscuridad y cambia de color en función de la temperatura.

No contact infrared body thermometer

It measures the body temperature in 1 second with no contact. High precision and speed with no need for contact. With the backlight LCD screen, it allows the use in the dark and changes color depending on the temperature.

130/0022  
Termómetro Digital Infrarrojos  
No contact infrared thermometer



CARACTERÍSTICAS / FEATURES

Grados Celsius y Fahrenheit  
Celsius and Fahrenheit degrees

Almacena un histórico de hasta 20 mediciones  
It saves the history of the lasts 20 measurements

Alarma para mediciones superiores a 38°C o 100.4°F  
Alarm if the temperature is higher than 38°C or 100.4°F

Apagado automático después de 30 segundos  
Auto power off after 30 seconds



## Máscara Facial

Transparente, con certificado SGS. Indispensable para cocinas centrales, restaurantes, cátering, pastelerías, eventos, bares y obradores, manipulación alimentaria y todo tipo de tiendas de alimentación (mercados, supermercados).

Evita las salpicaduras de saliva durante el trabajo.

**ESTABLE Y CÓMODA:** se adhiere al mentón perfectamente gracias a su barra inferior y sus tensores regulables.

**USO PROLONGADO:** no se empaña, no se mueve, larga duración.

**LIMPIA Y TRANSPARENTE:** mejora la imagen de su negocio aportando higiene y seguridad y ofreciendo una imagen amable y cuidada.

**SOSTENIBLE:** puede ser desmontada, desinfectada, reutilizada, y finalmente reciclada.

## Facial Cover

Transparent protective cover, with SGS manufacturing certificate. It is an essential accessory for central kitchens, restaurants, catering, food handling and all kinds of food stores (markets, supermarkets).

**ERGONOMIC, STABLE AND COMFORTABLE:** through its lower bar and its adjustable tensioners, it adheres perfectly to the chin.

**PERFECT FOR EXTENDED USE:** it does not fog up, it does not move, it has a long life and can be repeatedly cleaned and disinfected with alcohol.

**CLEAN AND CLEAR:** it improves the image of your business by providing hygiene and safety and offering a friendly and carefully image.

**SUSTAINABLE:** it can be disassembled, disinfected, reused, and finally recycled.



Personalizable  
Customizable



## Máscara facial Facial Cover

130/0020 Base Transparente / Clear Lower Bar

130/0021 Base Blanca / White Lower Bar

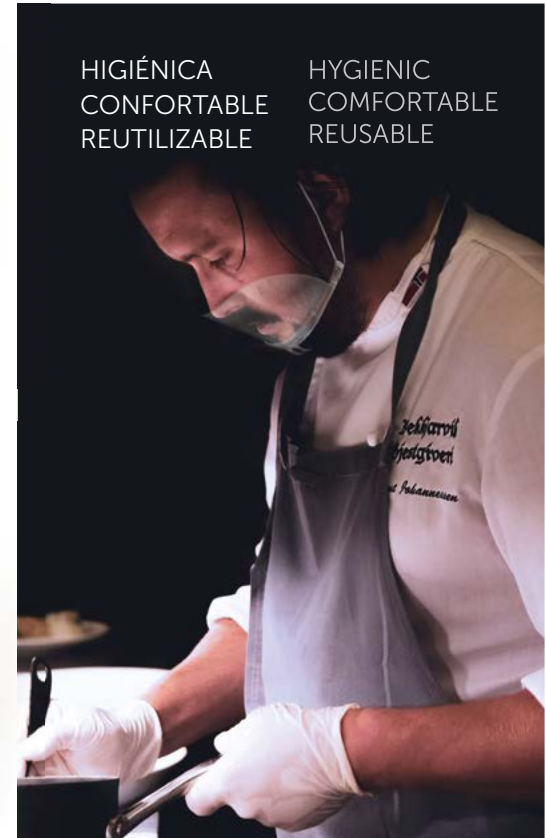

HIGIÉNICA  
CONFORTABLE  
REUTILIZABLE

HYGIENIC  
COMFORTABLE  
REUSABLE

# Needle



Agujas de baño  
Coating needle

El accesorio requerido para trabajar los miméticos y otros elementos bañados pequeños. Gracias a su finura, permite elaborar acabados perfectos (sin marcas); y operar con buena sujeción (para bañar y escurrir).

- Chocolates
- Trufas líquidas / Liquid truffles
- Falsos esféricos / False spheres
- Miméticos / Trompe l'oeil

The required accessory for working with small coated elements and other mimetics. Thanks to its finesse, it allows for perfect finishes without marks and provides a good grip for coating and draining operations.

30/0101  
Agujas de baño  
Coating needle

100 uds  
pcs



O2 Absorber



Sobres que contiene polvo de hierro que actúa de barrera contra la oxidación producida por el aire. Elimina o disminuye el nivel de oxígeno en el embalaje, ayudando a mantener la seguridad alimenticia del alimento y prolongar su vida útil. En un recipiente correctamente sellado, puede duplicar e incluso triplicar la vida útil del producto a conservar.

Envelope containing iron powder that acts as a barrier against oxidation produced by air. It eliminates or reduces the level of oxygen in the packaging, helping to maintain the food safety of the food and prolonging its shelf life. In a properly sealed container, it can double or even triple the shelf life of the product to be preserved. Each sachet can protect an area of 100 ml.

70/0047  
Oxygen absorber

150 uds  
pcs

1 sobre cada 100 cc.  
1 sachet for 100 cc.





# silca bag

Gel secante de sílice  
Desiccant silica gel

Un secante altamente higroscópico, con una gran capacidad de absorber la humedad ambiental, alargando así la vida útil de secos, liofilizados, caramelos, crujientes y deshidratados.

A highly hygroscopic drying agent with a great capacity to absorb ambient moisture, thereby extending the shelf life of dried, freeze-dried, candies, crisps, and dehydrated products.

Disponible en 3 formatos  
Available in 3 formats

70/0044 100 uds pcs  
SilcaBag S 10 g

Pensado para poder disponer una o dos bolsas en botes cerrados y así mantener cualquier deshidratado. Polvo, galleta, caramelo, etc. perfectamente crujiente.

Designed to allow you to place one or two bags in sealed containers, keeping any dehydrated product, such as powder, cookies, candies, etc. perfectly crispy.



10 uds pcs

70/0045  
SilcaBag M 150 g

Añádalo a recipientes de gran tamaño para absorber la humedad en producciones de restaurante, catering y obrador, manteniendo los crujientes, galletas, caramelos, etc. perfectos desde su elaboración hasta su uso.

Add it to large containers to absorb moisture in restaurant, catering, and bakery productions, keeping crisps, cookies, candies, etc., perfect from preparation to serving.



1 uds pc

70/0046  
SilcaBag L 1000 g

El aliado definitivo contra la humedad. Este formato de bolsa permite reutilizar el gel de Sílice, secándolo para reactivarlo en horno, microondas o deshidratador. Para detectar fácilmente cuándo hay que renovarlo, Silcabag incorpora una parte de perlas naranjas, que cuando se humedecen cambian a color verde.

The ultimate ally against moisture. This bag format allows you to reuse the Silica Gel by drying it to reactivate it in an oven, microwave, or dehydrator. To easily detect when it needs to be replaced, Silcabag incorporates orange beads that change to green when they become damp.





# Sous Vide

Cocina y técnicas al vacío

Vacuum Cooking Techniques



# NOON®

## FORCE & CLASSIC

80/1058  
Noon Force - 2250 W - 230V



Watt  
2250

Noon es la herramienta profesional definitiva para cocer con precisión alimentos envasados al vacío, infundionar, pasteurizar alimentos previamente cocinados o regenerar cualquier tipo de producto con total seguridad y comodidad, además de realizar cocciones programadas con un alto nivel de precisión. Esta referencia ya clásica de nuestro catálogo ha sido revisado y mejorado aumentando con ello su eficiencia productiva.

Noon is the ultimate professional tool for cooking vacuum-packed foods with precision, infuse ingredients, pasteurize, heat up any type of produce. Noon Immersion Circulator ensures a safe and easy programmed cooking, with accurate time and temperature control. This already classic reference in our catalog has been revised and improved, thus increasing its production efficiency.

### ¿QUÉ NOON ESCOGER? HOW TO PICK YOUR NOON?

NOON FORCE		NOON CLASSIC
54 L	100°C	27 L
65 L	80°C	35 L
75 L	70°C	45 L
100 L	60°C	54 L

\*Temperaturas medidas en cubetas isotérmicas Noon

\*Temperatures measured in isothermal containers Noon

80/0058  
Noon Classic - 1800 W - 230V

80/0059  
Noon Classic - 1400 W - 110V



Watt  
1800



Técnicas de cocina a baja temperatura y vacío  
Sous vide  
cooking techniques

**FREE EXTRA CONTENT**



Estabilidad térmica en recipientes profundos  
Thermal stability in deep containers

Precisión de temperatura 0.1 °C  
Temperature accuracy 0.1 °C

Presión de la bomba  
Pump pressure 115 Mbar

Caudal de agua  
Water flow 6 L / min



Control presión de agua  
Water control pressure



Dos ventiladores  
Two fans



Tubo conexión bomba de agua  
Water pump connecting pipe



**Control de parámetros en 10 idiomas**  
**Controllers in 10 Languages**





80/0044

Container térmico inox con tapa  
Stainless Steel Thermal Container with lid

80/0040

Tapa / Waterlight cover

Para baños GN 1/1  
For GN 1/1 baths



Los baños térmicos mejoran la estabilidad de la temperatura del agua, facilitan su calentamiento además de permitir una enorme comodidad en su vaciado y, lo que es más importante, un ahorro de un 30% en energía.

Todas la series de baños térmicos noon están equipadas con tapa estanca, asa y desagüe.

Thermal containers improve water temperature stability, make its heating easier, allow comfortable emptying, and save up to 30% of energy.

All our Noon thermal baths series are equipped with a sealed cover, a handle and a drain.



80/0055

Sujetasifón y botellín regulable  
Adjustable Whip Clip



80/0051

Cinta adhesiva rotulable 55 m  
Writable tape 55 m



6 colores  
6 colors

Ancho / Wide: 2 cm



El mejor sistema para el marcaje de bolsas de vacío, barquetas y todo tipo de recipientes, cristal, plástico, acero inoxidable. Resistente al agua. Puede emplearse en hornos de vapor, baños, congelador, nevera, o estufas calentaplatos. Puede escribirse con cualquier lápiz, bolígrafo o rotulador permanente. Al despegar no deja residuos.

Label vacuum bags or any food container with this water resistant writable tape. It can be used with any kind of container, from glass to plastic to stainless steel. Use it in steam oven, immersion circulator, freezer, refrigerator, hot plates or stove. No trace glue.



Descubra todas la aplicaciones de Vortex

Discover all applications with Vortex

**FREE EXTRA CONTENT**

# vortex

El agitador al vacío  
The Vacuum Stirrer

Consiga emulsiones y texturas sin airear y sin ninguna burbuja de aire sin necesidad de castigar su máquina de vacío. Mezcla gluconolactato, alginato, goma xantana, gelatina, aceites y estabilizantes, todo en frío.

Achieve impossible emulsions and textures with no ventilation and obtain bubble-free juices without the need to overuse your vacuum machine.

Mix portion of cold gluconolactate, alginate, xanthan gum, jelly, oils and stabilizers. Use not recommended with fibrous fruit purées or aired products.



20/0007  
VORTEX

MODELO COMPATIBLE | 230 V / 50 Hz  
COMPATIBLE MODEL | 110 V / 60 Hz



**3000 RPM**



Vacío con máquina de vacío, con o sin conexión externa  
Sous-vide with Vacuum Machine, with and without external connection



Sous-vide with Vacuum Pro



1300W



80/0096  
Noonie

220-240V 50-60 Hz

# noonie

EL MÁS GRANDE ENTRE LOS PEQUEÑOS  
THE BIGGEST AMONG THE SMALL

Precisión temperatura +/- 0,1°C  
Temperature accuracy +/- 0,1°C

Temperatura máxima 90°C  
Max. temperature 90°C

Para baños de 6 - 15 L  
For baths of 6 - 15 L

Alarma bajo nivel agua  
Low water level alarm

Pinza sujeción universal  
Universal clamping pliers

Válido GN 1/2 20 cm  
GN 1/2 20 cm valid

4 modos de cocción  
4 cooking modes

Temporizador hasta 99 h  
Timer up to 99 h



CIRCULADOR A BAJA TEMPERATURA SEMI-PRO  
SEMI-PRO LOW TEMPERATURE CIRCULATOR

Noonie utiliza la tecnología más avanzada en circuladores del mercado. Con una precisión de 0,1°C, incluso a temperaturas inferiores a 50°C, este circulador garantiza resultados precisos y consistentes en cada preparación.

Su versatilidad destaca al poder ser acoplado en una amplia variedad de recipientes, adaptándose a sus necesidades. Además, su potencia de 1300W permite calentar baños de hasta 15 litros en cuestión de minutos. Perfecto para producciones de menor volumen, regeneraciones, desayunos, buffets, sifones, salsas y mucho más.

Noonie utilizes the most advanced technology in circulators available in the market. With a precision of 0.1°C, even at temperatures below 50°C, this circulator guarantees precise and consistent results in every preparation. Its versatility stands out as it can be easily attached to a wide variety of containers, adapting to your needs. Additionally, its power of 1300W allows for heating baths of up to 15 liters within minutes. Perfect for smaller volume productions, regenerations, breakfasts, buffets, siphons, sauces, and much more.

**NOONIE EN LAS COCINAS PROFESIONALES**

En las cocinas tenemos equipos potentes para asegurar producciones, pero también necesitamos equipos de menor potencia en las partidas, para producciones de menor volumen, regeneraciones, desayunos, buffets, sifones, salsas, etc.

**¡¡AVISO PARA BARTENDERS Y BARISTAS!!**

Circulador rápido para volúmenes medios y pequeños, compatible en la propia barra de servicio. No renuncie a crear sus propias bebidas calientes, infusiones, etc.

**NOONIE IN PROFESSIONAL KITCHENS**

In the kitchens we have powerful equipment to ensure production, but we also need less powerful equipment in the batches, for smaller volume production, regenerations, breakfasts, buffets, siphons, sauces, etc.

**NOTICE FOR BARTENDERS AND BARISTAS!!**

Fast circulator for medium and small volumes, compatible with the service bar itself. Don't renounce to create your own hot drinks, infusions, etc.



15 L

80/0097

Cubeta con tapa Noonie  
Container with cover Noonie

GN 1/2 20 cm / GN 1/2 20 cm valid

# Cal Attack

DESCALCIFICADOR / DESCALER

Limpia la cal y oxidación de las resistencias, bombas de agua, sondas o materiales metálicos o plásticos de los baños térmicos de precisión, baños maría del pase o del buffet, lavavajillas, calentadores de agua, etc. Mantenga todos sus equipos Sous Vide en perfectas condiciones ahorrando agua y sobre todo electricidad.

Cleans scale and oxidation from electric resistances, water pumps, probes or metal or plastic materials of precision thermal baths, water baths of the pass or buffet, dishwashers, water heaters, etc.

Keep all your Sous Vide equipment in perfect conditions saving water and electricity.

80/0110  
Cal Attack

700 gr

Dosificación: 50 gr x 10 l  
Disolver y trabajar a 60°CDosage: 50 gr x 10 l  
Dissolve and work at 60°C

# iSensor

La nueva generación de envasadoras al vacío

## Envasado inteligente.

Equipadas con sistema iSensor, para bajos costes en mantenimiento, reparaciones y consumo. Ajusta automáticamente el vacío óptimo para cada producto: incluso líquidos, alimentos húmedos y alimentos porosos. iSensor permite realizar un envasado sin supervisión alguna y optimizar el tiempo de ciclo de envasado de forma automática, permitiendo la perfecta extracción de aire de espumas, masas, y batidos. [Barra de sellado inteligente](#) "Envase el doble de rápido".

Envase dos bolsas superpuestas en la misma posición con el tiempo de una.

## Nueva electroválvula.

Mejor eficiencia de cualquier ciclo de vacío independientemente de su presión.

## La envasadora al vacío 100% automática programada para infusiones y osmosis

## The 100% automatic vacuum packing machine programmed for infusions and osmosis

New Generation Vacuum sealer

## Intelligent Vacuum Sealer.

Perform the vacuum sealing level for each product: even for liquid, moist or porous food. iSensor optimizes the packing cycle.

## Special Sealing Bar "Packing in half the time".

The special design of the sealing bar makes possible to pack two bags placed on top of each other in the same position.

This way, twice the number of bags can be packed in the same amount of time.



8 m<sup>3</sup>/h

80/0060 iSensor S - 230V  
80/1060 iSensor S - 115V

38 x 54 cm Altura / Height: 38 cm  
Barra sellado / Sealing bar: 31 cm

Panel de control en modo AUTO o MANUAL  
Control display with AUTO or MANUAL mode



Modo AUTO ▶ Envase de manera automática sin supervisión

Modo MANUAL ▶ Ideal para combinar técnicas culinarias específicas, como impregnaciones, marinados, y colorear y aromatizar

AUTO mode ▶ Automatic sealing with no supervision

MANUAL mode ▶ Ideal for combining specific culinary techniques, such as impregnations, marinated, and color and flavor.





Conexión para vacío externo  
External Vacuum Connection



80/0070 Para iSensor · Fits iSensor

80/0025 Para Vacuum Pro y Girovap  
Fits Vacuum Pro and Girovap

- Equipadas con Bomba BUSCH de última generación
- Sistema de autolimpieza del aceite incluido
- Barra de sellado sin conexiones
- Cumple con los estándares CE, UL y NSF
- Equipped with the last generation BUSCH pump
- Self-cleaning oil system included
- Seal bar without connections
- Meets CE, UL and NSF standards

10 m<sup>3</sup>/h

80/0061 iSensor M - 230V  
80/1061 iSensor M - 115V

48 x 56 cm Altura / Height: 45 cm  
Barra sellado / Sealing bar: 41 cm



20 m<sup>3</sup>/h

80/0062 iSensor M - 230V  
80/1062 iSensor M - 115V

48 x 56 cm Altura / Height: 45 cm  
Barra sellado / Sealing bar: 41 cm



20 m<sup>3</sup>/h

80/0064 iSensor L - 230V  
80/1064 iSensor L - 115V

62 x 57 cm Altura / Height: 47 cm  
Doble barra sellado / Double sealing bar: 41 cm x 2

DOBLE  
BARRA SELLADO  
DOUBLE  
SEALING BAR

# Vac-andcook

Bolsas de cocción para uso profesional  
Professional use cooking bags

Las bolsas Vac-andcook, al contrario de las bolsas tradicionales, están producidas para resistir y mantener sus propiedades para cocción a baja temperatura y pasteurización.

Vac-andcook bags, on the contrary to the usual bags, are produced to resist and keep its properties for low temperature and slow cooking.

Agua o vapor hasta **+24h** **120°C/248°F**  
Water and steam up to

Microondas y ultracongelación **-40°C/-140°F**  
Microwave and deep-freezing

Grosor **95 microns**  
Thickness

Composición: 20 micras Poliamida, 75 micras Polipropileno  
Composition: 20 microns Polyamide, 75 microns Polypropylene



## Cocción / Cooking

80/0072	XS	20 x 15 cm	100	uds pcs
80/0074	S	20 x 30 cm		
80/0076	XL	35 x 50 cm	50	uds pcs
80/0100	XS	20 x 15 cm	500	uds pcs
80/0101	S	20 x 30 cm		
80/0102	M	25 x 35 cm		
80/0103	L	30 x 40 cm		
80/0104	XL	35 x 50 cm		



Marcadas con el sello de calidad COOKING 120°C / 248°F  
Quality mark COOKING 120°C / 248°F

# Vac-andsave

Bolsas de conservación para profesionales  
Storing bags for professionals

Perfectas para el empaquetado en fresco de productos de todo tipo.

La gran variedad de tamaños permite adaptar cada envasado a la bolsa idónea.

Permiten congelación y atemperado hasta 85°C en cocciones de corto tiempo de exposición al calor.

Perfect bags for fresh packaging of all kinds of products.

The wide variety of sizes allows each packaging to be adapted to the ideal bag.

They allow freezing and tempering up to 85°C for short cooking times.

Grosor  
Thickness **90 microns**

Composición: 20 micras Poliamida, 70 micras Polipropileno  
Composition: 20 microns Polyamide, 70 microns Polypropylene



## Conservación / Storing

80/0105	XS	20 x 15 cm
---------	----	------------

80/0106	S	20 x 30 cm
---------	---	------------

80/0107	M	25 x 35 cm
---------	---	------------

80/0108	L	30 x 40 cm
---------	---	------------

80/0109	XL	35 x 50 cm
---------	----	------------

500 uds  
pcs



Fabrique bolsas a medida. Cierre todo tipo de bolsas plásticas de polipropileno hasta galga 300, poliamidas, PVC fino. Específicamente apropiada para la elaboración de preparados con Oblat

Produce your own bags of any size. Close all kinds of polypropylene plastic bags, PVC. Specifically suitable for the preparation of recipes with Oblat

## Selladora Oblat® Oblat® sealer

50/0005 [C 200]	Soldadura / Seal length: 20 cm
-----------------	--------------------------------

50/0006 [C 300]	Soldadura / Seal length: 30 cm
-----------------	--------------------------------





# VACUUM PRO

Bomba de vacío compacta y portátil  
Compact and portable vacuum pump

La tecnología a doble ciclo: más potente y rápida que la empacadora de sobremesa.

Equipada con conexión externa, compatible con todo tipo de válvulas o envases al vacío, vacuómetro de precisión para controlar el nivel de vacío, fácil mantenimiento y una gran versatilidad para aplicar cualquier técnica de vacío en su cocina.

Double cycle technology: much more powerful and faster than a countertop vacuum machine. Equipped with external connection, it is compatible with all types of valves or vacuum packaging. Equipped with precision vacuum gauge to control the vacuum level.

Vacuum Pro is easy to maintain and features a great versatility to apply any vacuum technique to your kitchen.



VACÍO PRÁCTICO Y VERSÁTIL DONDE Y CUANDO QUIERAS  
PRACTICAL AND EASY SOUS VIDE WHENEVER YOU WANT

Vacuum Pro

80/0028 | 230V

80/0029 | 115V

4 -4.8 m<sup>3</sup>/hour

230 V - 50 Hz: 150 W

110 V - 50 - 60 Hz: 150 W

CE + UL Certificate

Garantía / Warranty: 1 año / year







80/0025

Conexión Vacuum-Pro Standard (recambio)  
External Vacuum Pro Connection (replacement)

01

80/0026

Aceite Atóxico para Vacuum Pro  
Vacuum Pro Atoxic Oil

02

80 ml



VACÍO CON EL VASO VORTEX  
SOUS VIDE WITH VORTEX GLASS

## Spider Pipette

Disco rellenador de pipetas automático  
Automatic disc filler for pipettes

SPIDER PIPETTE

80/0023

Pipetas Rectas y Mini / Straight & Mini Pipettes



63

Pipetas a la vez  
Pipettes at the time

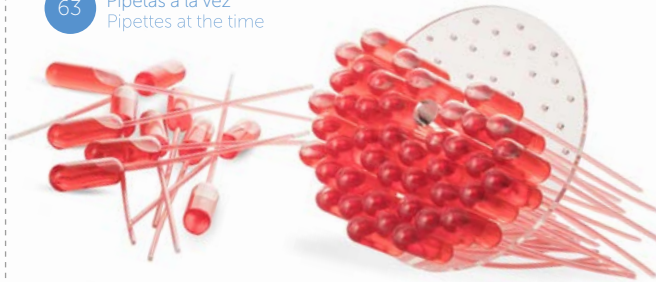

VACÍO CON MÁQUINA  
SOUS VIDE WITH VACUUM MACHINE





## BrickVac

### Cubetas para vacío Vacuum Containers

Conserve productos al vacío sin que la presión o la humedad los dañen. Ideal para: verduras, ensaladas, rocas de chocolate o queso, infusiones e impregnaciones de salmueras, jarabes, productos liofilizados o deshidratados, trabajos de azúcar y caramelo, crujientes, pastas y Obulatos.

Sous-vide store your products (like salads, greens etc.) without damaging them with pressure or moisture. Now you can easily make chocolate or cheese aero, vacuum brining, vacuum impregnation and so on. BrickVac allows short term storage of freeze-dried or dehydrated products, as well as preserving sugar crafts, caramel, biscuits, crunchy snacks, pastry and Obulato.

### BrickVac GN1/1

Cubetas Inox / Stainless Steel Containers

80/0080 | GN1/1 100 53 x 33 cm Altura / Height: 10 cm **7.6 L**

80/0081 | GN1/1 150 53 x 33 cm Altura / Height: 15 cm **13 L**

80/0082 | GN1/1 200 53 x 33 cm Altura / Height: 20 cm **20 L**

Tapa policarbonato / Polycarbonate Cover

80/0084 | GN1/1 53 x 33 cm Altura / Height: 4 cm

### BrickVac GN1/2

Cubetas Inox / Stainless Steel Containers

80/0083 | GN1/2 150 33 x 27 cm Altura / Height: 15 cm **5.6 L**

Tapa policarbonato / Polycarbonate Cover

80/0085 | GN1/2 33 x 27 cm Altura / Height: 4 cm



White Chocolate Soufl-Air

Complemente sus cubetas con las conexiones externas para las máquinas de vacío Vacuum Pro (p. 96), iSensor (p.92).

BrickVac containers also work with external vacuum plugs for Vacuum Pro (p. 96), iSensor (p.92).



Técnicas y consejos de vacío manual express  
Smart sous vide techniques and tips

**FREE EXTRA CONTENT**



Conservación en botes  
Storage glass container



Impregnación al vacío  
Vacuum impregnation



Cocina a baja temperatura  
Vacuum cooking



Conservación en bolsas  
Small quantities conservation

# Click-it

## Sistema de vacío manual Smart Sous-Vide System

Click-it es el sistema manual más sencillo para envasar al vacío cualquier tipo de producto sin utilizar ninguna máquina. Válvula con clip reutilizable para transformar cualquier bolsa de plástico o bote en un envase perfecto para el vacío.

Click-it is the simplest system to pack sous-vide any type of product without using a machine. The kit contains reusable clips and valves made to transform any plastic bag or jar into a sous-vide food container.



80/0091  
Click-It Kit

Click-it contiene:

- la bomba manual de vacío
- 3 válvulas
- 3 clips
- 3 bolsas de cocción

Click-it Kit contains:

- the manual vacuum pump
- 3 valves
- 3 clips
- 3 Click-it Cooking bags

20 uds  
pcs

80/0093  
Click-it Bolsas de cocción  
Click-it Cooking Bag

20 uds  
pcs

80/0092  
Click-It Bolsas de conservación  
Click-it Storing Bag





## Destilador Profesional para alimentos y bebidas

Diseñado para ofrecer respuestas a las necesidades de los Chefs y Bartenders, Girovap agiliza y perfecciona los procesos de destilación, re-destilación, extracción, descomposición y re-composición, reducción y concentración, abriendo espacios para nuevas preparaciones.

**BOMBA DE VACÍO DE MEMBRANA**  
Succión 15L/min, alto nivel de vacío.

**VASO DE DESTILACIÓN**  
Hasta 3,5L de producto trabajado, sin giro, sin fugas de líquidos.

**SISTEMA DE ROTACIÓN MAGNETICO**  
Homogeneización de temperatura  
Trabajo con productos semi-sólidos y espumantes.

## Professional Distiller for food and drinks

Designed to respond to the needs of Chefs and Bartenders, Girovap improves and refines the distillation, re-distillation, extraction, breakdown and re-composition, reduction and concentration processes, opening up spaces for new preparations.

**DIAPHRAGM VACUUM PUMP**  
15L/min suction, high vacuum level.

**DISTILLATION VESSEL**  
Up to 3,5L of working capacity with no turns, without liquid leaks.

**MAGNETIC ROTATION SYSTEM**  
Homogenisation of temperature  
It works with semi-solid and sparkling products.



**GIROVAP**  
Destilador Profesional  
Professional Distiller

30/0050  
230 V

30/1050N  
110 V

57.5 x 40 cm Altura / Height: 38 cm



El manual de usuario incluye explicaciones detalladas y un curso de iniciación sobre los procesos de combinación entre el vacío y la temperatura

The user manual includes detailed explanations and an initiation course to understand the processes of the combination between vacuum and temperature



Acceso directo a las técnicas de destilación  
para gastronomía y coctelería  
Free access to distillation techniques  
for gastronomy and mixology

**FREE EXTRA CONTENT**

- 🔥 Menor coste de producción / Lower cost of production
- 🔥 Fácil mantenimiento / Easy maintenance
- 🔥 Accesorios modulares / Modular accessories
- 🔥 Múltiples usos en un solo equipo / Multiple uses in a single unit
- 🔥 Tamaño Reducido / Reduced size
- 🔥 Alto nivel de vacío / High vacuum level
- 🔥 Mayor precisión de temperatura / Higher temperature accuracy
- 🔥 Gran capacidad y velocidad / High capacity and speed
- 🔥 Fácil Manejo / Easy Handling

## ¿Qué puedo hacer con Girovap?

Re-destilaciones alcohólicas con sabores y aromas  
Destilación de hidrolatos y esencias  
Desalcoholización en vinos y licores  
Coulis, confituras y mermeladas sin azúcares añadidos  
Concentración de azúcares naturales de pulpas de fruta  
Reducción de lácteos a leches condensadas (animales o vegetales)  
Reducción de elementos grasos (yema), de vinagres, sojas, tabascos,  
Aromatización de ingredientes mediante impregnación (nibs de cacao, granos de café, frutos secos, azúcares, sales,...)

## What can I do with Girovap?

Re-distillation of alcohol with the addition of flavors  
Distillation of hydrolates and essences  
Dealcoholization of wines and liquors  
Coulis, confitures and jams without added sugars  
Concentration of natural sugars from fruit pulps  
Reduction of any milk to condensed milks (animal or vegetal)  
Reduction of fatty elements (yolk)  
Reductions of vinegars soy sauces, tabascos,...  
Aromatization of ingredients by impregnation (cocoa nibs, coffee beans, nuts, sugars, salts,...)



El futuro de la destilación para la cocina y la coctelería  
The future of distillation for cooking and cocktails





## Vinos desalcoholizados / De-alcoholized wine

Girovap permite rebajar el grado alcohólico de cualquier vino o bebida alcohólica de su carta sin perder sus propiedades organolépticas en apenas 20 minutos.

Girovap allows to decrease the alcohol content of any wine or alcoholic drink of your menu without to lose its organoleptic properties, in just only 20 minutes.



Mire ahora el vídeo de las recetas creadas por nuestros clientes  
Watch now the video containing the recipes created by ours clients  
[FREE EXTRA CONTENT](#)

## Cocteleria / Mixology

La destilación abre nuevos caminos en la coctelería en la creación de bitters y tinturas, en la utilización de los hidrolatos en la producción a escala, o para perfumar hielos o combinados con matices de autor ... y muchas más técnicas posibles.

Distillation opens new paths in the cocktail industry to create bitters and tinctures, to use floral waters in scale production, or to perfume ices or cocktails with signature nuances... and many more possible techniques.



¡Aplique las técnicas de perfumería en sus recetas y cócteles!

Apply perfume-making techniques to yours recipes ans cocktail-making!



## Cocina

**DESTILAR:** lo importante es el producto resultante del proceso: un líquido con apariencia de agua -alcohol, vinagre o agua- totalmente transparente y con un sabor y un aroma marcado)

**CONCENTRAR:** -el camino más interesante para los chefs-, se pueden obtener elaboraciones ultra concentradas: reduciendo el agua de los productos: obteniendo texturas de coulis o confituras sin azúcares añadidos para base de sorbetes; productos grasos concentrados (cremas dobles, natas con un alto % MG, leches condensadas de cualquier leche animal o vegetal, pomada de yema de huevo; caldos, jugos y reducciones sin temperatura (salsas colagenosas, demi glaces,...); reducciones de vinagres hasta conseguir salsas cremosas con un potencial inexplicable.

Además podemos impregnar ingredientes con presión y cocción a baja temperatura (tales como frutos secos, granos, sales,...) para posteriormente obtener elaboraciones con un carácter único (chocolates y pralinés estables de alcohol,...).

<b>Sake</b> Sake	<b>Cerveza</b> Beer	<b>Vino tinto</b> Red wine	<b>Vino dulce</b> Sweet wine	<b>Vino blanco</b> White wine
<b>Jerez</b> Sherry	<b>Vermouth</b> Vermouth	<b>Bitter</b> Bitter	<b>Aperitivos</b> Appetizers	<b>Cordiales</b> Spirits

## Cooking

**DISTILLING:** the important thing is the product resulting from the process: a liquid with the appearance of water - alcohol, vinegar or water - totally transparent and with a marked flavor and aroma)

**CONCENTRATING:** -the most interesting way for chefs-, ultra concentrated elaborations can be obtained: reducing the water of the products: obtaining coulis textures or jams without added sugars for sorbet base; concentrated fatty products (double creams, creams with a high % Fat, condensed milks of any animal or vegetable milk, egg yolk pomade; broths, juices and reductions without temperature (collagenous sauces, demi glaces,..); vinegar reductions to obtain creamy sauces with an inexplicable potential.

We can also impregnate ingredients with pressure and low-temperature cooking (such as nuts, grains, salts,...) to subsequently obtain elaborations with a unique character (alcohol stable chocolates and pralines,...).



# Girovap

distiller-pro

Accesorios originales  
Original accessories



80/0025  
Conexión Girovap para vacío externo  
Girovap external Vacuum Connection

2 uds  
2 pcs  
30/0078  
Juntas vaso Girovap  
Joints Girovap Vessel



2 uds  
2 pcs  
30/0102  
Hoja teflón Girovap  
Girovap teflón sheet



3 uds  
3 pcs  
30/0079  
Juntas VA032 para chupón  
Vacuum connection joints VA032



10 uds  
10 pcs  
30/0076  
Frasco y gotero de cristal graduado  
Bottle and graduated glass drippers 120 ml



30/0052  
Alcoholómetro con probeta 100 ml  
Alcoholmeter with test tube



30/0051  
Decantador Kit 500 ml  
Decanter Kit

Incluye: decantador, pinza de sujeción y pie  
Includes: decanter, clamp and foot



1,5 L



Vasos graduados Girovap  
Girovap measuring glasses

30/0071	1,5 L
30/0070	3 L
Ø 15 cm	



3 L

Vaso especial 5 L  
Special 5 L glass

Vaso de gran capacidad con el que podrá hacer producciones de hasta 4 L en una sola destilación.

Large capacity glass with which you can make productions of up to 4 L in a single distillation.

30/0083  
Serpentin vaso 5 L  
Serpentine for 5 L Glass

Necesario para trabajar con el vaso de 5 L  
Necessary to work with the 5 L glass



30/0081  
Vaso Girovap  
Girovap Glass

5 L

Ø 15 cm







| nitro®





Más info en: / Find out more on:  
www.100x100barman.com

100% Barman

cool\*bar

## Escarchador de copas clásico Classic Glasses Froster

Alto rendimiento y mucha rapidez en el trabajo. Enfríe copas y recipientes de cristal o cerámica en segundos, sin necesidad de instalación previa y sin mantenimiento. Coolbar enfría copas y vasos a -45°C instantáneamente.

Diseñado para un gran volumen de copas, puede ser utilizado en lugares donde su explosividad es irrelevante, tales como clubs, bares o discotecas donde la música es predominante y lo que el cliente busca es rapidez y espectacularidad.

High-performances, quick work. Cool and frost cocktail glasses or any glass or ceramic container in few seconds. Coolbar does not require special tools or maintenance. It can instantly frost glasses and cups up to -45°C.

Designed for high volume production of iced cups: it can be used in places where its noise is irrelevant, such as clubs, bars, crowded places where the music covers the noise and where the customer wants rapidity and spectacular effects.

THE  
BARTENDER'S  
FAVORITE!

COBRE / COPPER

120/0028  
CoolBar Classic 230 V

120/0030  
CoolBar Classic 115 V



PLATA / SILVER

120/1028  
CoolBar Classic 230 V

120/1030  
CoolBar Classic 115 V

PERSONALIZADO  
CUSTOMIZED

120/3000





YouCook

NITRO & CO2 TECHNIQUES AT:  
www.100x100barman.com



FROST GLASSES



80s

PRODUCE DRY ICE



DRY ICE PELLETS

120/2028  
CoolBar 2 - 230 V Cobre - Copper

120/3038  
CoolBar 2 - 115 V Cobre - Copper

120/4048  
CoolBar 2 - 230 V Plata - Silver

120/5058  
CoolBar 2 - 115 V Plata - Silver

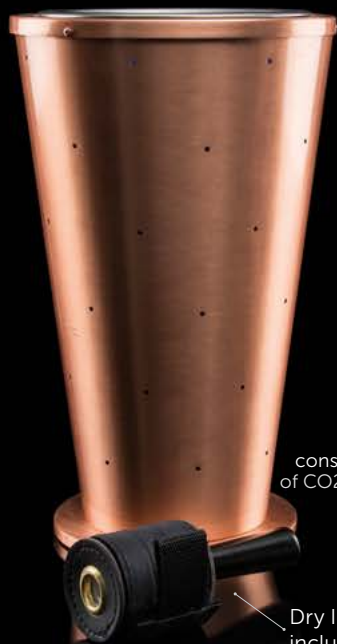

-30%  
consumo de CO2  
of CO2 consumption

Dry Ice Black  
incluido / included



coolbar.2

Escarchador de copas con Dry Ice  
Glasses Froster with Dry Ice

¡2 en 1!

CoolBar 2 le permite congelar copas y crear sus propias pastillas de hielo seco y delante del cliente sin tener que cambiar de botella o conexión. Gracias a su nuevo sistema reductor de salida del gas podrá congelar sus copas en unos segundos y, enroscando el condensador CO2 Dry Ice Black, podrá fabricar pellets de hielo seco al momento. Particularmente silencioso, permite un alto rendimiento en bares de hoteles, restaurantes, coctelerías y lugares que necesiten discreción.

2 in 1!

CoolBar 2 frost your glassware or produce your dry ice tablets on demand, all in front of a client and with no need to change a bottle or connection. The new gas exit reduction system means you can freeze your glassware in just seconds and with the CO2 Dry Ice Black Condenser attached, you can instantly make dry ice pellets. Particularly quiet. It allows a high performance in lounge bars, and more discrete venues.

CoolBar2 is suitable for RESTAURANTS · LOUNGE BAR · HOTELS

Más info en: / Find out more on:  
[www.100x100barman.com](http://www.100x100barman.com)

**100% Barman**



## DRY ICE BLACK

Condensador de hielo seco

Dry Ice Condenser

Dry Ice Black es el condensador de hielo seco más completo del mercado. Pensado para agilizar el trabajo del profesional frente al cliente, garantiza efectos espectaculares y de calidad.

**RÁPIDO:** menos de 1 minuto para una pastilla de 30 g 12 segundos para pastillas de 11 g.

**EFICIENTE:** reduce el desgaste de CO2 del 30%

**SEGURO:** podrá utilizarlo sin riesgo alguno en cocktelería, buffets, presentación de platos, etc.

**FÁCIL:** Compatible con todas las botellas de CO2 líquido con tubo sonda. Incluye manual de instrucciones.

Dry Ice Black is the most complete dry ice condenser in the market, designed to fasten the professional work and to bring special effect to your venue.

**RAPID:** One 30 g tablet is ready in less than 1 minute. Only 12 seconds to produce a 11 g tablet.

**EFFICIENT:** Equipped with a pressure reduction filter, it lessens the CO2 expense up to 30%.

**SECURE:** Use it safely in cocktail bars, buffets, catering and plate presentation.

**EASY:** Compatible with any liquid CO2 cylinder equipped with probe tube. User guide included.

Ø 5 cm  
30 g in 20 seconds

CO2 - DRY ICE BLACK  
Condensador de hielo seco  
Dry Ice Condenser

120/1015 EU Connection

120/2015 USA Connection

Ø 5 cm  
90 g in 60 seconds

CO2 - DRY ICE BLACK TRIPLE  
Condensador de hielo seco  
Dry Ice Condenser

120/0053 EU Connection

120/0054 USA Connection



120/0046  
DRY ICE PELLETS  
Moldeador instantáneo  
Dry Ice Instant Mold



11 g Pellet  
Ø2 x 2.5 cm



## DRY ICE **BLACK TRIPLE**

Big-production

Las mismas propiedades y facilidad de uso, pero ¡multiplicadas por 3!

Produzca una tableta de 90 g de hielo seco al instante, listo para utilizar, ahorrando tiempo y esfuerzo.  
Ideal en caterings, coctelerías y restaurantes de gran producción.

The same properties and ease of use, but multiplied by 3!

Produce a 90 g tablet of dry ice instantly, ready to use, saving time and effort.  
Ideal for caterers, cocktail bars and high production restaurants.



4 uds  
pcs  
**160/5109**  
DRY ICE CAPSULE

Ø 2,5 cm x 7 cm

Inserte la cápsula de hielo seco dentro de sus bebidas con seguridad.

Insert the dry ice capsule safely into your beverages.

2 uds  
pcs  
**120/0047**  
DRY ICE MIXER  
Mezclador de hielo seco  
Dry Ice Stirrer

22 cm



Disponible también en formato más grande para cócteleras:  
Also available in bigger size for cocktail mixers:  
Mix&Dry Kit - 160/0111, p. 245.





## Nitro Bowl

120/0019	S	∅ 8 cm	125 ml	120/0016	L	∅ 18 cm	0.8 L
120/0018	M	∅ 13 cm	350 ml	120/0029	XXL	∅ 22 cm	2.5 L

Todos los diámetros son exteriores, sin contar el asa / All diameters exclude the handle

Debido al proceso de producción artesanal, las medidas pueden variar hasta  $\pm 20\%$   
 Sizes can vary by about  $\pm 20\%$  due to the artisanal creation process

Boles de varios tamaños de doble cámara térmica con vidrio reforzado. Perfectos para elaborar delante del cliente cocktails, helados y sorbetes con LN<sup>2</sup>, así como coctelería molecular u originales presentaciones en cáterings o eventos con hielo seco o LN<sup>2</sup>.

Double-chamber thermal bowls, made with stronger glass, available in different sizes. Prepare perfect liquid nitrogen ice cream and sorbets in front of the client, mix molecular cocktails and original show-cooking for events or catering with dry ice or LN<sup>2</sup>.



## Nitro Glass

120/0017  
Nitro Glass

0.75 ml

∅ 9 cm





## Vaso Dewar Dewar Flask

Vaso Dewar con forma de bowl, fabricado en vidrio borosilicato con aislamiento por vacío. Ideal para la elaboración de helados y sorbetes con nitrógeno líquido, así como envase para la cocción en nitrógeno y elaboraciones a la vista del cliente.

Hemispherical Dewar flask, made with borosilicate and vacuum insulated. An indispensable tool for liquid nitrogen cooking, to prepare ice creams and sorbets in front of the client thanks to its perfect capacity.

120/0003  
Vaso Dewar  
Dewar flask



Diámetro interno  
Internal diameter  
Ø 20 cm

## Jarra nitro + Nitro jug +

120/0051	0.6L	Ø 13 x 17 cm
120/0052	1 L	Ø 14 x 21.5 cm

Jarra térmica especial para los trabajos con LN<sup>2</sup>, fabricada íntegramente en acero inoxidable, con doble cámara sellada al vacío. Mantiene el nitrógeno durante horas sin apenas pérdida. Tapón de seguridad especial para nitrógeno.

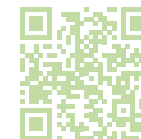

Sea un maestro  
en nitrógeno líquido  
Be a master  
in liquid nitrogen

**FREE EXTRA CONTENT**

Special thermo jug designed to work with LN<sup>2</sup>. Made entirely of stainless steel, with double vacuum-sealed chamber. It keeps the nitrogen for hours with hardly any loss. With a special security cap for liquid nitrogen.





## Salva-G® TEPPAN NITRO

Su gran térmica permite tener un consumo moderado de nitrógeno. La plancha es capaz de llegar a muy bajas temperaturas. Excelente en el trabajo continuo.

The nitrogen consumption is moderate, due to its outstanding insulation properties. The included radial griddle reaches very low temperatures. Excellent in continuous work.

120/0002  
Teppan Nitro Salva-G

3.5

Teppan: 27 x 21 cm  
Container: 43 x 27 x 15 cm

120/0020  
Plancha adicional para  
Teppan Nitro Salva-G  
Griddle for Teppan  
Nitro Salva-G



3 mm Plancha  
Griddle

Doble cubeta con 2 tapas y 1 plancha  
Double basin with two lids and a griddle



# Salva-G® MINI

Plancha nitro para efectuar trabajos en la mesa del cliente o presentaciones para cocktelería.

Prepare small showcooking directly on the table or the bar.

120/0021

Plancha Teppan mini Salva-G  
Teppan nitro mini Salva-G

0.3 L

12 x 12 cm Altura / Height: 9 cm

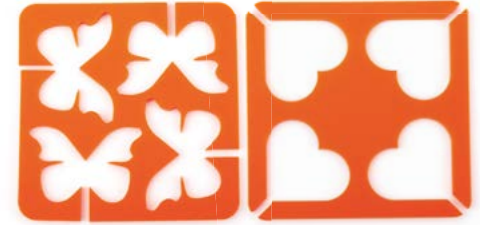
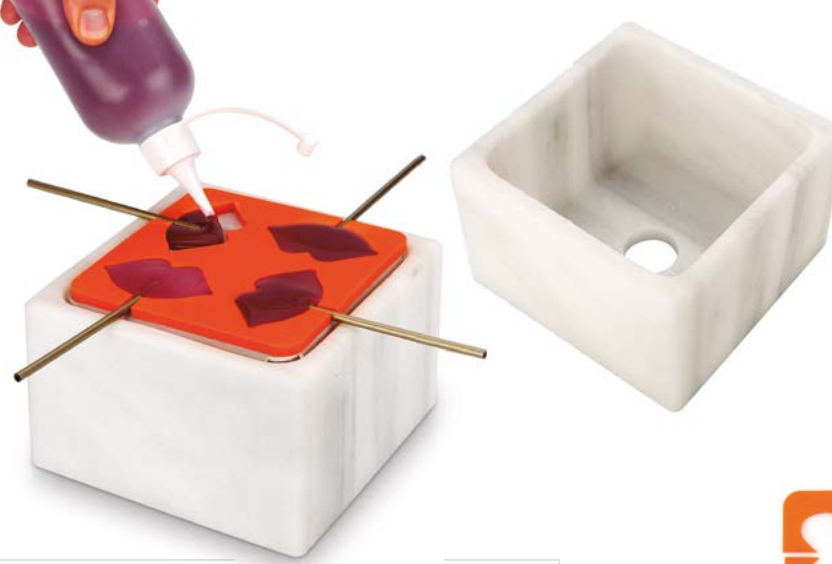

120/0043

Estuche presentación marmol de blanco para Teppan mini  
White Marble Presentation Container for Mini Teppan

14 x 14 cm Altura / Height: 9 cm

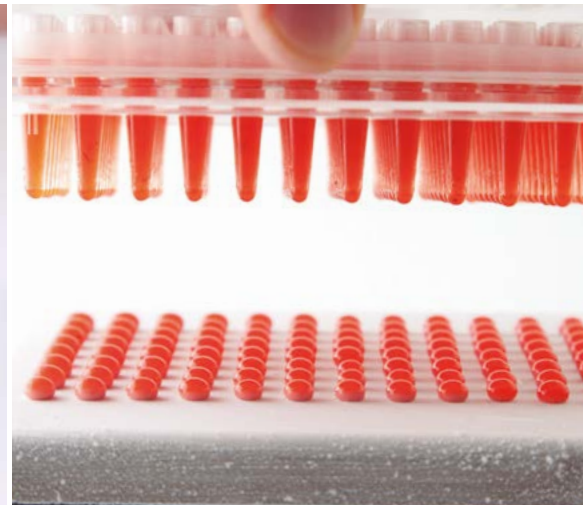

## Nitro Mould Lollipop

120/0038 Gingerman

120/0040 Mariposa · Butterfly

120/0041 Corazón · Heart

12 x 12 cm



## Termo Contenedores DEWAR para LN<sup>2</sup> LN<sup>2</sup> DEWAR Insulated Containers

**120/0027**  
Transferidor INSTANT  
INSTANT transfer kit

Permite extraer de manera sencilla y eficaz el nitrógeno líquido de su contenedor. Compatible con cualquier tamaño y marca de contenedor Dewar.

A simple and efficient way to extract liquid nitrogen from your storage tank.

For any Dewar container size or model.



**120/0004**  
Par de guantes Nitro  
Nitro Gloves (pair)



**120/0012**  
Máscara de protección  
Face shield



**120/0007**  
Contenedor de nitrógeno  
Nitrogen Container

Ø: 33 x Altura / Height: 62 cm

20 L



Conexión NV50

Para todos los modelos  
For all models

**120/0006**  
Contenedor de nitrógeno  
Nitrogen Container

Ø: 30 x Altura / Height: 56 cm

10 L



**120/0008**  
Contenedor de nitrógeno  
Nitrogen Container

Ø: 45 x Altura / Height: 65 cm

30 L



Todos los contenedores llevan funda de protección / All Dewar containers are equipped with protective sleeve



### Nitro Coulant Mould

120/0025 Redondo · Round

120/0026 Cuadrado · Square

4 x 4 cm / Ø: 4 cm  
 Altura / Height: 8 cm



### Spray Nitro

120/0013 300 ml

120/0014 500 ml



Sea un experto en  
 nitrógeno líquido  
 Be a expert  
 in liquid nitrogen

**FREE EXTRA CONTENT**

### NITRO Relief

Grabador de bronce macizo con grabado en oblicuo para facilitar el formado de logos o formas en espumas o coulis realizadas en Teppan Nitro Salva-G. Personalizamos todo tipo de formatos, consúltenos, somos especialistas!

Solid bronze seal, customized with diagonal engraving, to perform techniques with liquid nitrogen.

Imprint your logo on mousses, foams and coulis on Teppan Nitro Salva-G. Contact us to get more info and a professional advice.

100/0162  
 Nitro Relief









Stone Age



## Ebanon

190/1002 Negro · Black Ø 20 cm

190/1003 Marrón · Brown Ø 22 cm

Alt / Height: 3 cm

## STONE AGE

Platos y soportes tallados en exclusivo mármol de Macael. Todas las piezas son únicas e irrepetibles, talladas y pulidas para ofrecer a nuestro cliente una experiencia única.

Nuestro amplio y original catálogo puede personalizarse a la medida y color en muy poco tiempo de producción y cantidades mínimas.

Plates and trays carved in pure Macael marble. All pieces are unique and unrepeatable.

They are carved and polished to offer our customers a unique experience. All the marble plates of our catalogue can be personalized to any size and little minimum order quantities.



### 190/1004

Reef

10 x 13 cm \*

Alt / Height: 5 cm



## Imperator

190/0013 Amarillo / Yellow

190/0014 Verde / Green

190/0101 Rojo / Red

20 x 10 cm \*

Alt / Height: 2 cm





2 uds  
pcs  
190/1001  
Trevolato

Ø 29 cm  
Alt / Height: 3 cm



190/1008  
Pluma  
Feather

35 x 11 cm  
Alt / Height: 3 cm



Baya cacao  
Cocoa bean

170 ml

190/0055 Verde · Green

190/0056 Blanco · White

21 x 8 cm  
Alt / Height: 6 cm



Ø 11.5 cm

190/1005  
Ovalo

25 x 17 cm  
Alt / Height: 3 cm



\* Las medidas son aproximadas pudiendo variar entre un 20/30% / The marble plates sizes can vary between 20/30%

## MÁRMOLES DE COLOR COLORED MARBLE

Un proceso natural acelerado por un sistema único de teñido con pigmentos minerales.

A natural process accelerated by a unique dyeing system with mineral pigments.

190/1015  
Bol coral rojo  
Red coral bowl

700 ml

Ø 18 cm  
Alt / Height: 7.5 cm



190/1010  
Corvus

Ø 20 cm \*  
Alt / Height: 1.5 cm

2 uds  
pcs



Agarre fácil  
Easy to grasp

190/1016  
Intellato

30 x 20 cm  
Alt / Height: 1.5 cm

2 uds  
pcs



### Atención:

Los platos pueden presentar texturas variadas y veteados con diferentes colores debido a que están fabricados con mármol natural. El teñido puede no quedar uniforme debido a las diferentes compactaciones de la piedra natural en la cantera. Los platos son únicos e irrepetibles.

### Please note:

The plates may present varied textures and veining with different colours due to the fact that they are made from natural marble. The dyeing may not be uniform due to the different compaction of the natural stone in its quarry. The plates are unique and unrepeatable.





### Abaco

190/1017 Naranja · Orange

190/1018 Azul · Blue

190/1019 Rojo · Red

2 uds  
pcs

Ø 28 cm  
Alt / Height: 1 cm



Canto rústico  
Rustic Rim





### Circus

190/0016 XS 17 x 15 cm

190/0048 XL 25 x 23 cm

Alt / Height: 3 cm



Campanas Aladín / Aladín cloches: 10/0013 - 10/0014



Campanas Aladín / Aladín cloches: 10/0015 - 10/0016



Campana  
NO incluida.  
Debe encargarse  
por separado.

Cover not  
included.  
It must be  
ordered separately.







190/0015  
Rhombus

25 x 24,5 cm  
Alt / Height: 2 cm



### Compagne

190/0111 Verde / Green

190/0112 Rojo / Red

18 x 26 cm Alt / Height: 2 cm



190/1000  
Syro

Ø 35 cm  
Alt / Height: 3 cm



Ø 17 cm



lado plano  
flat side

190/0010  
Granito doble cara  
Granite double face

300 ml

22 x 12 cm  
Alt / Height: 4 cm



lado ahuecado  
hollowed side



190/0021  
Rústico doble / Rustic double

20 x 10 cm \*  
Alt / Height: 2 cm



Jordi Cruz / Abac Restaurant

190/0011  
Granito / Granite

20 x 15 cm  
Alt / Height: 2 cm



190/0020  
Rústico hondo / Rustic deep

19 x 12 cm \*  
Alt / Height: 2 cm



190/0019  
Rústico llano / Rustic flat

19 x 12 cm \*  
Alt / Height: 2 cm



190/0022  
Fortuna / Fortune

19 x 11 cm  
Alt / Height: 2 cm



190/0023  
Fuente / Fountain

19 x 11 cm  
Alt / Height: 2 cm

190/0040  
Meteorite

Ø central 4 cm  
17 x 15 cm \*  
Alt / Height: 2 cm



190/0044  
Circus Purpurina / Glitter Circus

25 x 18 cm  
Alt / Height: 2 cm



190/0041  
Golf

21 x 17 cm \*  
Alt / Height: 2 cm







190/0114  
Block  
4 x 18 cm  
Alt / Height: 4 cm

2 uds  
pcs



190/0008  
Lágrima / Tear  
20 x 9 cm  
Alt / Height: 2 cm



190/0009  
Petit Fours  
20 x 7 cm  
Alt / Height: 2 cm



190/0001  
Roman XS  
11 x 22 cm



190/0002  
Roman XL  
13 x 27 cm



190/0018

Doble Laguna / Double Lagoon

40 ml

19.5 x 9.5 cm  
Alt / Height: 2 cm

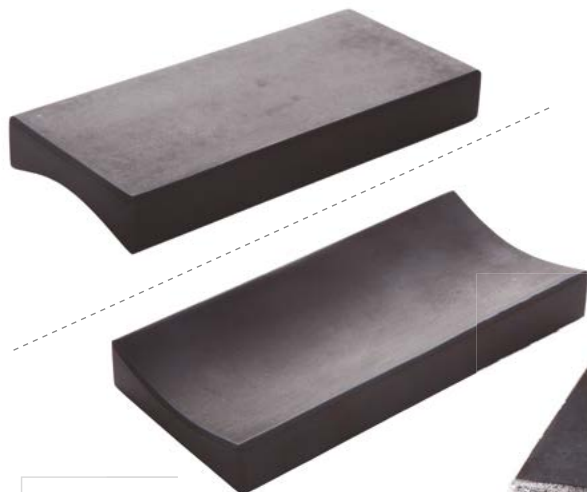

190/0006

Lingote / Ingot

15 x 7 cm  
Alt / Height: 2 cm



190/0007

Coliseum

30 ml

10 x 10 cm  
Alt / Height: 2 cm

Ø 7 cm

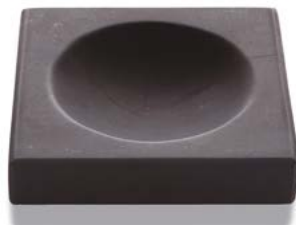

190/0017

Laguna / Lagoon

60 ml

18 x 14 cm  
Alt / Height: 2 cm



Como mantener los platos de piedra en perfectas condiciones.  
Tips for keeping stone plates in perfect condition.

**FREE EXTRA CONTENT**

190/0034

Laguna blanco / White Lagoon

60 ml

18 x 14 cm  
Alt/Height: 2 cm





## Barbacoa Fría / Cold BBQ

190/0115 MINI 16 x 17 cm Alt / Height: 6 cm

190/0024 XS 30 x 11 cm Alt / Height: 6 cm

190/0025 XL 30 x 16 cm Alt / Height: 6 cm



190/0012

Barbacoa mini  
Mini BBQ

15 x 11 cm\*  
Alt / Height: 10 cm



190/0116

Espeto

13 x 13 cm  
Alt / Height: 4 cm

25 cm







**190/0097**  
Mini Robata  20 cm  
16 x 13 cm  
Alt / Height: 5.5 cm



**190/0069**  
BBQ Charcoal Grill  25 cm  
20 x 13 cm  
Alt / Height: 15 cm

**190/0082**  
BBQ Robata  20 cm  
25 x 16 cm  
Alt / Height: 6 cm



Malla inox media  
Medium Stainless Steel Mesh  
+ info p. 385



 Pincho robata 25 uds pcs  
180/0008 S 20 cm  
180/0007 L 25 cm



\* Las medidas son aproximadas pudiendo variar entre un 20/30% / The marble plates sizes can vary between 20/30%  
Pinchos y malla no incluidos / Skewers and Mesh not included





Corner plate

190/0037	Simple	8 x 8 cm	2 uds pcs
190/0038	Double	16 x 8 cm	

190/0053	XL	13 x 13 cm
----------	----	------------

190/0054	XXL	20 x 17 cm
----------	-----	------------

Alt / Height: 0.5 cm



190/0064  
Osaka

20x13 cm  
Alt / Height: 2 cm



190/0092

Corner Plate Textura Madera  
Wood Textured Corner Plate

2 uds  
pcs

20 x 9 cm  
Alt / Height: 0.5 cm



190/0065  
Tokyo

21 x 21 cm  
Alt / Height: 3 cm

190/1006

Giove

600 ml

Ø 18 cm

Alt / Height: 7 cm



190/0090

Plato Sushi Mármol  
Marble Sushi Plate

24 x 8 cm

Alt / Height: 3+1 cm



190/0087

Olla de mármol con tapa cerrada  
Marble pot with lid

300 ml

Ø 15 - Alt / Height: 10 cm

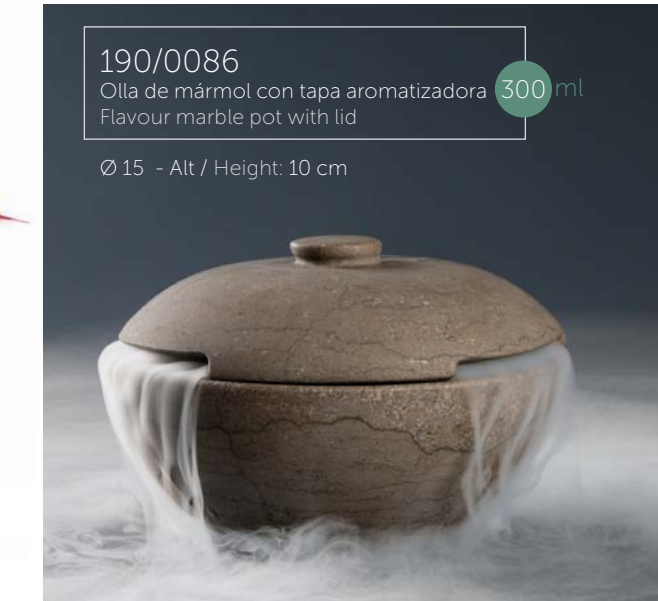

190/0088

Paleta pintor de mármol  
Marble Painter Palette

23 x 18 cm

Alt / Height: 1,5 cm



190/0086

Olla de mármol con tapa aromatizadora  
Flavour marble pot with lid

300 ml

Ø 15 - Alt / Height: 10 cm



Plato redondo blanco  
White round plate

190/0075 XS Ø 25 cm

190/0076 XL Ø 30 cm

Alt / Height: 3 cm



190/1011  
Abaco Orion

2 uds  
pcs

Ø 25 cm  
Alt / Height: 2 cm



Aprenda cómo curar los platos  
de piedra para una larga duración  
Learn how to cure stone plates  
for a long life

**FREE EXTRA CONTENT**



Grabado laser / Laser Engraving

190/0070  
Plato Blonda  
Stone Doily Plate

Ø 20 cm

Plato Al-Ándalus rojo  
Red Al-Ándalus plate

190/0098 XS Ø 25 cm

190/0099 XL Ø 30 cm

Alt / Height: 2 cm



Plato redondo negro  
Black round plate

190/0073 XS Ø 25 cm

190/0074 XL Ø 30 cm

Alt / Height: 3 cm

Negro y rojo con canto rústico  
Black and Red with Rustic Rim

Longo

190/2035 Tray 40 x 16 cm

190/2036 Plate 27 x 12 cm

Alt / Height: 2 cm







Crocodile

2 uds  
pcs

190/1020 Redondo / Round Ø 25 cm

190/1021 Rectangular 30 x 20 cm

Alt / Height: 1 cm

Bol frío  
Cold bowl

450 ml

190/0077 Vintage

190/0027 Blanco / White

Ø 20.5 cm Alt / Height: 6 cm



Ø 12 cm



190/0079  
Disco Nitro / Nitro Disk

Ø 14 cm

190/2037

Cúpula  
Dome

Ø 14,5 cm

Alt / Height: 7cm





## Jabugo

190/0106	Tapa	Ø 20 cm
190/0107	Ración	Ø 25 cm
190/0108	Homenaje	Ø 30 cm

Plato de mármol blanco abombado con superficie texturizada para evitar adherencias y diseño curvo para un fácil agarre. Personalizable en tamaño y color.

White marble curved dish with textured surface to prevent sticking and curved design for easy grip. Customizable in size and color.



## Atoll

190/2032 Blanco / White

190/2033 Gris / Grey

190/2034 Sierra Elvira

Ø 27 cm Alt / Height: 2 cm

190/2040  
Mini mortero  
Mini mortar  
Ø 11,5 x 5,6 cm





Esfera / Sphere

190/0042 Blanco / White

190/0043 Gris / Grey

Ø 15 cm Alt / Height: 9 cm



190/0039  
Big Sphere

Ø 20 cm  
Alt / Height: 8 cm



190/1013  
Bol Rustic  
Rustic Bowl

Ø 18 cm  
Alt / Height: 6 cm

190/1007  
Bol colmena  
Beehive Bowl

250 ml

Ø 18 cm  
Alt / Height: 6 cm

190/1014  
Diamond

600 ml

Ø 18 cm  
Alt / Height: 6 cm





190/1009  
Starfish

250 ml

18 x 8 cm  
Alt / Height: 6 cm



190/0047  
White Moon

Ø 8 cm  
16 x 16 cm  
Alt / Height: 2 cm



Canto Rústico / Rustic Rim

### Imperial

190/0102 Blanco / White

200 ml

190/0103 Gris / Grey

17 x 17 cm Alt / Height: 7 cm



190/0078  
Super Bowl

700 ml

Ø 20 cm  
Alt / Height: 6 cm





190/0080

Plato Apicius  
Apicius Plate

ØExt: 22 cm\*  
Altura / Height: 2 cm



Compatible con / Use with:  
Ø 14 cm, 10/0013 y 10/0014



190/0031  
Planet

90 ml

10.5 x 4 cm  
Campana incluida  
Cloche included



190/0032  
Iceberg

Campana no incluida  
Cloche not included

23 x 20 cm  
Alt / Height: 2 cm

Faraon

190/0028    Amarillo / Yellow

190/0029    Verde / Green

15 x 17 cm \*  
Alt / Height: 2 cm



190/0030

Faraón cúpula recambio  
Spare Faraon cover

Ø 10 cm  
Alt / Height: 10 cm

Campana incluida / Cloche included

Ø 14 cm

Campanas Aladín  
Aladín cloches  
(10/0013 - 10/0014)

Roca porta brochetas  
Rock skewer support

190/0059	Verde / Green	2 agujeros / holes
190/0060	Blanco / White	12 x 6.5 cm - Alt / Height: 5 cm *
190/0061	Verde / Green	4 agujeros / holes
190/0062	Blanco / White	14 x 9 cm - Alt / Height: 7 cm *



190/0089  
Piedra raíz con huecos  
Root stone with holes

10 x 14 cm \*  
Alt / Height: 7 cm



Soporte pinza sushi  
Sushi tong stand

2 uds  
pcs

190/0072-B	Blanco / White
190/0072-G	Gris / Grey
190/0072-V	Verde / Green

\* 9 x 7 cm  
Alt / Height: 4 cm



Hueco/Hole:  
Ø 3 mm

Ramas no incluidas Branches not included

\* Las medidas son aproximadas pudiendo variar entre un 20/30% / The marble plates sizes can vary between 20/30%

190/0091  
Posa cubiertos  
Cutlery Support

12 x 4 cm  
Alt / Height: 2.5 cm

4  
uds  
pcs



190/0071  
Soporte helados  
Ice Cream Tray

14 x 7 cm  
Alt / Height: 2 cm

Stand corcho  
Cork stand

190/0050	Single	10 x 7 cm
190/0051	Double	12 x 10 cm
190/0052	Triple	10 x 24 cm
190/0100	Champagne	12 x 10 cm

Alt / Height: 2 cm

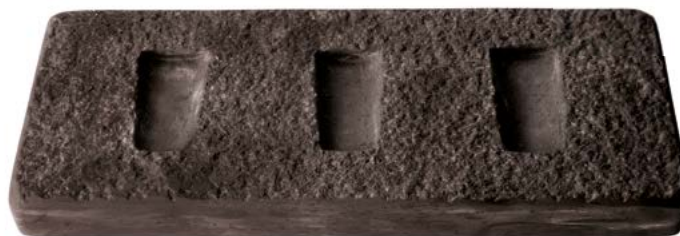





Aprenda cómo curar los platos de piedra para una larga duración  
Learn how to cure stone plates for a long life

**FREE EXTRA CONTENT**



190/0045  
Cube

Ø 4 cm  
6 x 6 cm  
Alt / High: 6 cm



190/0104  
Rubicube

9 x 9 cm  
Alt / High: 9 cm



190/0036  
Soporte cono Macael  
Macael Cone Support

Ø 4.5 cm 8 x 8 cm  
Alt / High: 8.5 cm



Dado  
Dice

190/0066 Pinzas y brochetas / Tongs and skewers

190/0067 Conos / Cones

5 x 5 x 5 cm

6 uds  
pcs









Puente / Bridge

190/0026 25 x 6.5 cm Alt / Height: 6 cm

190/0096 XS 14 x 6.5 cm Alt / Height: 5.5 cm

Huevos de porcelana no incluidos  
Porcelain eggs not included

Caesar

- |          |                   |   |
|----------|-------------------|---|
| 190/0003 | Amarillo / Yellow |  |
| 190/0004 | Verde / Green     |  |
| 190/0005 | Gris / Grey       |  |



Bloque de sal no incluido  
Salt block not included



190/0007  
Coliseum





Soporte mármol  
Marble support

- |          |                   |
|----------|-------------------|
| 170/0005 | Amarillo / Yellow |
| 170/0007 | Azulado / Bluish  |
| 170/0008 | Gris / Grey       |

15 x 10 cm \*  
Alt / Height: 12 cm

Para planchas de / For block sizes:

- |   |                                  |   |                                  |
|---|----------------------------------|---|----------------------------------|
|  | 10 x 10 cm<br>Alt / Height: 2 cm |  | 10 x 14 cm<br>Alt / Height: 2 cm |
|---|----------------------------------|---|----------------------------------|

El Kit se compone de / The kit includes:

Base mármol  
Marble base

Tubo de ensayo 90 ml  
One 90 ml probe tube

Tapón negro de silicona  
Silicone black cap

Accesorios extra / Extra accessories:

Cepillo para limpieza / Cleaning brush:  
Ref. 100/0145, pag.353.

Tubos y tapones extra / Extra tubes and caps:  
Ref. 100/0172,100/0173, pag.322.



**190/0081**  
Kit Soporte Labo Soup  
Test Tube Soup Kit

12.5 x 6 cm  
Alt / Height: 3.5 cm

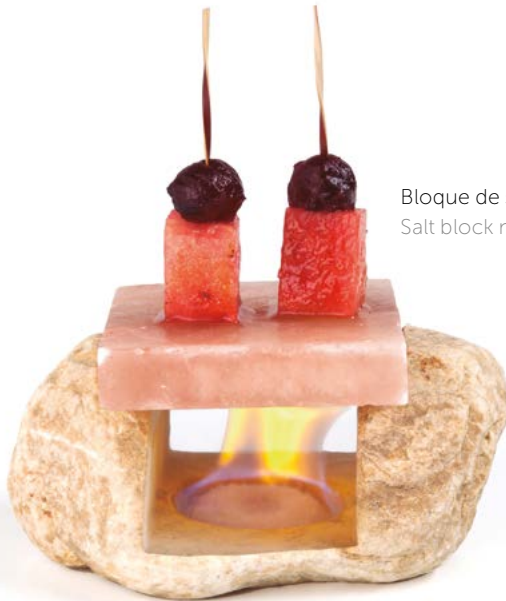

Bloque de sal no incluido  
Salt block not included



**190/0063**  
Roca porta conos  
Yellow Cones Support

9.5 x 9 cm \*  
Alt / Height: 7 cm  
2 agujeros / holes



**190/0113**  
Paradiso Club

8 x 19 cm Ø 1,6 cm  
Alt / Height: 5 cm

\* Tubo de ensayo no incluido  
\* Probe tube not included

## NEKON

Nekon es un material innovador similar al mármol, con características únicas para la fabricación de platos y piezas de servicio.

Su composición no porosa previene la proliferación de bacterias y su elevada dureza le confieren una resistencia superior.

Es fácil de limpiar, su textura no produce ruido ni causa abrasión por el uso de cubiertos metálicos. Ligero y resistente a los ácidos de los alimentos.

Nekon looks like marble, is an innovative material with unique bacteria and its high hardness provides superior resistance. It is easy to clean and its texture does not produce noise or cause abrasion when used with metal cutlery. Light weight and resistant to food acids.

### Agreste

190/2024 Blanco / White

190/2025 Negro / Black

30 x 10 cm Alt / Height: 2 cm



### The hand

190/2030 Blanco / White

190/2031 Negro / Black

24 x 11 cm Alt / Height: 5 cm



### Cave

190/2026 Blanco / White

190/2027 Negro / Black

15 x 13 cm Alt / Height: 5 cm



## Pool

190/2028 Blanco / White

190/2029 Negro / Black

41 x 25 cm Alt / Height: 2 cm

## Silk

190/2038 Blanco / White

190/2039 Negro / Black

19 x 19 cm Alt / Height: 2 cm



## NEKON



Ultra resistente, el Nekon no se hace añicos, y es perfecto para un uso intensivo, así como apto para áreas de piscina o playa.

### **NO SE DESCONCHA NI SE MANCHA**

Ultra-durable, the Nekon is perfect for heavy-duty use and won't shatter easily and perfect in pool or beach areas.

### **CHIP RESISTANT, DOESN'T STAIN**



## Panal

190/2022 Blanco / White

190/2023 Negro / Black

Ø 17 cm Alt / Height: 5 cm



# Himalaya

## Planchas de sal

La placa de cristal de sal puede ser calentada o refrigerada llegando a temperaturas extremas, desde -196°C hasta el fuego directo. La superficie transmite la temperatura de forma uniforme. El grosor del bloque mantiene la temperatura durante 20-30 minutos.



Salt blocks



Salt crystal plates can be heated or cooled to reach extreme temperatures, from -196°C to direct fire. The surface of the salt transmits the temperature evenly. The thickness of the block keeps the temperature up to 20-30 minutes.



**170/0004**

Plancha de sal  
Salt block

29 x 21 cm  
Alt / Height: 4 cm

**170/0002**

Plancha de sal rectangular  
Rectangular salt block

14 x 10 cm  
Alt / Height: 2 cm

**170/0001**

Plancha de sal cuadrada  
Square salt block

10 x 10 cm  
Alt / Height: 2 cm

170/0003

Soporte metal Himalaya  
Himalaya metallic support

40 x 24 cm

Alt / Height: 14 cm

Para ref / For ref: 170/0004



**AISI  
316**

Acero inoxidable  
Stainless-steel

Bloque de sal no incluido.  
Pensado para calentar encima  
de nuestra cocina o llevar  
la piedra caliente a la mesa  
y cocinar frente a nuestro  
cliente.

Salt block not included.  
Designed to be used right  
on your stove or to bring  
hot directly to the table  
and to cook in front of your  
customer.

Kit Himalaya

170/0006

Kit Himalaya



PARA COCINAR EN LA PROPIA MESA  
SALT BLOCK COOKING SUPPORT

Soporte de dos módulos ensamblables  
(acero inoxidable 18/10)  
Two interlocking modules support  
(Stainless-steel 18/10)

Plancha de sal 29 x 21 x 4 cm  
Pink Himalayan salt block



Fogones de alcohol (2 uds.)  
Alcohol stove (2 pcs.)



Las planchas de sal pueden  
adquirirse de recambio:  
Ref. 170/0004

Spare salt blocks are available:  
Ref.170/0004



Porcelain





## Caníbal

Colección inspirada en elementos naturales, la réplica del original permite presentar esta variedad de piezas en exclusivos platos de porcelana.

## Cannibal

Inspired by the original natural shapes, they allow presenting food in its original form transformed into a porcelain dish.



210/0016  
Paletilla  
Shoulder Blade

Textura mate  
Matte Texture

33 x 20 cm Alt / Height: 6 cm



210/0020  
Brocheta Hueso  
Bone Skewer

3 uds  
pcs

Textura mate  
Matte Texture

Largo / Length : 18 cm



210/0017  
Gran Femur  
Big Femur

Textura mate  
Matte Texture

25 x 10 cm Alt / Height: 10 cm



TEXTURA:  
interior esmaltada  
exterior mate  
TEXTURE:  
glossy inside  
matte outside





Spa Drink XS 175 ml

210/0048 Blanco / White

210/0097 Oro / Gold

15 x 7 cm Alt / Height: 7 cm

Spa Drink XL 300 ml

210/0049 Blanco / White

210/0098 Oro / Gold

17 x 8 cm Alt / Height: 9 cm



210/0119  
Huevera  
Egg holder

2 uds  
pcs

19 x 12 cm Alt / Height: 8 cm



3 uds  
pcs

210/0100  
Sponge Porcelain

11 x 6,5 cm  
Alt / Height: 3,5 cm



210/0023  
Huevo avestruz  
Ostrich Egg

2 uds  
pcs

350 ml

Ø 8 cm Alt / Height: 10 cm \*





210/0022  
Huevo Roto  
Broken Egg

10 uds  
pcs

50 ml

Ø 4.5 cm Alt / Height: 5 cm

Interior brillo  
Glossy finish inside



35 ml



Huevos porcelana  
Porcelain eggs

6 uds  
pcs

210/0082 Blanco / White

210/0083 Naranja / Light brown

210/0084 Rosado / Blush pink

Ø 4.5 cm Alt / Height: 4 cm

Todos los modelos combinan con los siguientes soportes:  
All the models combine with the following supports:  
190/0040, 190/0045, 190/0036, 190/0026, 190/0096

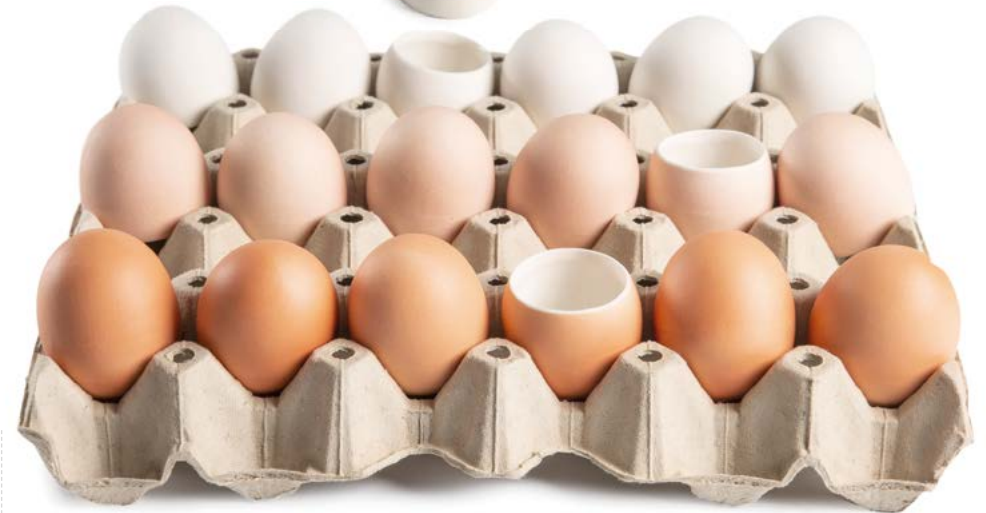

\*Soportes no incluidos / Supports not included



## SOFT TEXTURES

Piezas de porcelana con textura que imitan fibras o materiales, necesitará tocarlas para ver que no son de verdad. Ligeras y sorprendentemente realistas, permiten agasajar a sus clientes con presentaciones únicas y fuera de lo común.

Porcelain pieces with a texture that imitates fibres or materials. It is impossible to understand what it is made from!

Lightweight as feathers and surprisingly realistic, it allows to entertain your customers with unique and out of the ordinary presentations.

210/0025  
The Pillow

24 x 24 cm  
Alt / Height: 7 cm

2 uds  
pcs



280/1203  
Croquet pillow

25 x 13 cm  
Alt / Height: 2,5 cm

3 uds  
pcs



210/0041  
Lata conserva porcelana XL  
Porcelain can XL

Ø 10 cm Alt / Height: 18 cm

4 uds  
pcs



500 ml

210/0024  
Lata conserva porcelana XS  
Porcelain can XS

Ø 9 cm Alt / Height: 13 cm

4 uds  
pcs



220 ml



Gorro Ski  
Ski Beanie

210/0074 Blanco / White

210/0085 Azul / Blue

29 x 19 cm Alt / Height: 2 cm



210/0096  
Viga de porcelana  
Porcelain Beam

22 x 9 cm - Alt / Height: 11 cm



Acabado negro mate  
imitando el hierro  
Black Matte Finish  
mimicking iron



210/0075  
Sinatra

25.5 x 21.5 cm  
Alt / Height: 11 cm



210/0069  
Gaudi Bowl

3 uds  
pcs

Ø 20 cm  
Alt / Height: 4 cm



Brillo / Glossy

Mate / Matte

210/0081  
Caracola  
Seashell

350 ml

20 x 13 cm  
Alt / Height: 9 cm



Nacarado / Pearly



210/0070  
Gaudi XL

3 uds  
pcs

28 cm x 22 cm



210/0071  
Gaudi XS

3 uds  
pcs

22 cm x 19 cm





210/0118

Mejillón  
Mussel

18 x 9 cm

Alt / Height: 2 cm

3 uds  
pcs

210/0099

Pulpo a feira

22 x 20 cm

Alt / Height: 5 cm



210/0076

Txangurro  
Spider Crab

15.5 x 13 cm

Alt / Height: 4 cm

175 ml

210/0117

Escargot

22 x 20 cm

Alt / Height: 5 cm



Pruebe a ahumar sus escargots!  
Try smoking your escargots!





210/0029  
Mini Rock

Plato / Plate: 13 x 5 cm  
17 x 8 cm Alt / Height: 4 cm

210/0026  
Long Rock

Plato / Plate: 12.5 x 9.5 cm  
32 x 15 cm Alt / Height: 10 cm



210/0030  
Soup Rock

600 ml

Ø 14 cm Alt / Height: 10 cm



Interior textura brillo  
Glossy texture inside



Brillo / Glossy

210/0028  
Small Rock

Plato / Plate: 15 x 6 cm  
22 x 10 cm Alt / Height: 6 cm

Mate / Matte

210/0027  
Big Rock

Plato / Plate: Ø 10 cm  
22 x 19 cm Alt / Height: 8 cm



210/0120

Long Rock Deco

Plato / Plate: 12.5 x 9.5cm  
32 x 15 cm Alt / Height: 10 cm



210/0121

Mini Rock Deco

Plato / Plate: 13 x 5 cm  
17 x 8 cm Alt / Height: 4 cm



210/0123

Small Rock Deco

Plato / Plate: 15 x 6 cm  
22 x 10 cm Alt / Height: 6 cm



210/0122

Big Rock Deco

Plato / Plate: Ø 10 cm  
22 x 19 cm Alt / Height: 8 cm



Dune XS

210/0060 Brillo / Glossy

210/1060 Mate / Matte

Ø 23 cm Alt / Height: 7 cm



Dune taco

210/0061 Brillo / Glossy

210/1061 Mate / Matte

Ø 17 cm

Alt / Height: 7 cm



Dune XL

210/0059 Brillo / Glossy

210/1059 Mate / Matte

Ø 27 cm Alt / Height: 7 cm



210/0115  
Dune Craqueler Taco

Ø 17 cm  
Alt / Height: 7 cm



210/0113  
Dune Craqueler XS

Ø 23 cm  
Alt / Height: 7 cm

210/0114  
Dune Craqueler XL

Ø 27 cm  
Alt / Height: 7 cm







## SPHERIC

Inspirada en diseños y formas repetidas en multitud de culturas de los 5 continentes, esta vajilla permite emplatar aperitivos, líquidos, platos de cuchara o bebidas e incluso petit fours.

Inspired by designs and shapes repeated in cultures of the 5 continents, this tableware allows you to serve appetizers, liquids, spoon dishes or drinks, even petit fours.

### Spheric Dome

210/0104 Blanco / White

210/0112 Tabaco / Tobacco

210/0108 Negro / Black

Ø 16 cm Alt / Height: 10,5 cm



### Spheric Plate\*

210/0103 Blanco / White

210/0111 Tabaco / Tobacco

210/0107 Negro / Black

Ø 23 cm Alt / Height: 6 cm

\*Spheric Dome no incluido  
Spheric Dome not included



### Spheric Bowl\*

210/0102 Blanco / White

210/0110 Tabaco / Tobacco

210/0106 Negro / Black

Ø 16 cm Alt / Height: 8 cm

\*Spheric Dome no incluido  
Spheric Dome not included



### Spheric Sake

210/0101 Blanco / White

210/0109 Tabaco / Tobacco

210/0105 Negro / Black

Ø 12,5 cm Alt / Height: 5,5 cm



## Globus XS

210/0091	Azul / Blue
210/0092	Amarillo / Yellow
210/0093	Blanco / White
210/0094	Negro / Black
210/0095	Rosa / Pink

20 x 16 cm  
Alt / Height: 7 cm

Más medidas y colores disponibles bajo demanda  
More sizes and colors available on demand



210/0058  
Globus Bowl

500 ml

Ø 13 cm  
Alt / Height: 15 cm

Ø 10 cm



Globus XL

210/0056 Rosa / Pink

210/0086 Azul / Blue

210/0087 Amarillo / Yellow

210/0088 Blanco / White

210/0089 Negro / Black

23 x 20 cm  
Alt / Height: 7 cm

Más medidas y colores disponibles bajo demanda  
More sizes and colors availables on demand







210/0064  
Tronco Pequeño  
Trunk Small Plate  
Ø 17 cm  
Alt / Height: 10 cm

210/0065  
Plato Rama Alta  
Branch High Plate  
Ø 9 cm  
Alt / Height: 20 cm



210/0066  
Plato Rama Baja  
Branch Low Plate  
Ø 10 cm  
Alt / Height: 13 cm

## WOOD PLATES

Platos de porcelana simulando la madera natural. Textura, color y diseño realista. Vacío en su interior, lo convierte en un soporte ligero ideal para presentar platos y snacks.

Painted porcelain plate simulating natural wood. Texture, color and realistic design, its slight cavity makes it a stand ideal for the presentation of snacks or dishes.



210/0063  
Tronco Grande  
Trunk Big Plate  
Ø 23 cm  
Alt / Height: 7 cm



Carpaccio maderas  
Carpaccio wood

3 uds  
pcs

210/0068 XS 22 cm x 18 cm

210/0067 XL 27 cm x 21 cm



210/0040  
Wood Slice

Ø 32 cm Alt / Height: 4 cm





210/0078

Bandeja trenzada de porcelana  
Porcelain Braided Tray

30 x 15 cm

Alt / Height: 2 cm



210/0077

Plato trenzado de porcelana  
Porcelain Braided Plate

24 x 24 cm

Alt / Height: 2 cm

Panera de porcelana  
Porcelain Bread Basket

210/0079 XS Ø 21.5 x 1.5 cm

210/0080 XL Ø 26 x 1.5 cm





Tela de sacco  
Burlap plate

3 uds  
pcs

210/0073 XS 22 cm x 18 cm

210/0072 XL 27 cm x 21 cm



210/0039  
The Frame

Plato / Plate: 17 x 13 cm  
Marco / Frame 23.5 x 18.5 cm  
Alt / Height: 2.8 cm

Solicitelo con marco dorado  
Ask for golden frame







Ceramics Era



## Ceramics Era

Creaciones artesanales de gres  
Stoneware plates and supports

Platos y soportes modelados en gres y arcillas refractarias por las expertas manos de nuestros artesanos locales. Utilizando técnicas con esmaltes extremadamente resistentes, son ideales para presentaciones calientes o frías, ya que el material ayuda a mantener la temperatura más tiempo.

Dishes and supports modelled in stoneware and refractory clays by the expert hands of our local craftsmen. Using techniques with extremely resistant glazes. Ideal for hot or cold presentations, because the material helps to maintain the temperature for longer.



### Iluro

Vaporera / Steamer

280/0001	Morena / Moray
280/0002	Gris metálico / Metallic grey
280/0003	Arena / Sand
280/0004	Blanco / White

Ø 12 cm Alt / Height: 11 cm

Vaporera en miniatura con tapa, compuesta de 3 piezas. Ideal para servir pequeños bocados. Introduzca aromas en su vapor o bruma generada con hielo seco para una mayor experiencia sensorial del cliente.

Miniature steamer with lid composed of 3 pieces, ideal for serving small steamed creations. Introduce aromas in the lower piece, for a greater sensory experience for the customer.





280/0051 Caesar llano / Flat



280/0053 Caesar llano liso / Flat Smooth Rim

## EGARA



Egara  
Paleta / Palette

4 uds  
pcs

280/0041 Acabado metal / Metal finish

280/0042 Acabado madera / Wood finish

31.5 x 21 cm Alt / Height: 1 cm

## CAESAR PALACE

Ø 17 cm Alt / Height: 9 cm



280/0052 Caesar hondo / Deep



280/0054 Caesar hondo liso / Deep Smooth Rim





## TARRACO

Platos ultraligeros que gracias a su cámara térmica permiten conservar los alimentos calientes más tiempo una vez emplatados.

Ultra-lightweight plates, their thermal chamber allows food to keep warm for longer once it has been plated.



Tarraco  
Plato / Plate

3 uds  
pcs

280/0021

Morena / Moray

280/0022

Gris metálico / Metallic grey

280/0023

Arena / Sand

280/0024

Blanco / White

280/0025

Turquesa / Turquoise

Ø 25 x 17 cm Alt / Height: 5.5 cm

## BARCINO

La cerámica refractaria contiene partículas de esmalte del mismo color de la superficie para cada modelo.

The refractory ceramic contains glaze particles of the same colour as the surface for each model.



Barcino  
Plato / Plate

4 uds  
4 pcs

280/0011

Morena / Moray

280/0012

Gris metálico / Metallic grey

280/0013

Arena / Sand

280/0014

Blanco / White

280/0015

Turquesa / Turquoise

Ø 27 cm Alt / Height: 3.8 cm





PERSONALIZABLE  
CUSTOMIZABLE

Todas nuestras cerámicas pueden ser personalizadas tanto en esmaltes de diferentes colores, combinaciones de color, y acabados especiales.

All our ceramics can be customised both in glazes of different colours, colour combinations, and special finishes.



## GADES



1 L



### Gades

Bol / Bowl

6 uds  
pcs

280/0031

Morena / Moray

280/0034

Blanco / White

280/0032

Gris metálico / Metallic grey

280/0035

Turquesa / Turquoise

280/0033

Arena / Sand

Ø 21 cm Alt / Height: 6 cm





8 42CB32 P5TACH

# Serigrafood

Platos personalizados con sabor  
Customized dishes with flavour

Imprima sobre un plato llano, en tan solo 5 segundos y tantas veces como quiera, cualquier dibujo, escritura, logo o diseño, con salsas, mantequillas, purés de fruta... Con esta técnica puede realizar cualquier diseño y presentar platos de infinitas maneras y sabores.

Screen print on a flat plate in only 5 seconds!  
Customize your dishes by printing logos, designs and writings with handcrafted edible ink made with sauces, flavored butter or fruit purées.  
Who said it's forbidden to play with food?  
Wash the plate and repeat as much as you desire.



## CÓMO FUNCIONA HOW IT WORKS

1. Tensar la tela en el bastidor
  2. Encajar la tela encima del plato
  3. Extender la crema con la ayuda de una espátula
1. Tense the screen on the frame
  2. Place the screen on a perfectly dried plate
  3. Spread the chosen creamy texture with a spatula



## Serigrafood

Rectangular 28 x 43 cm

210/0050 Tela / Canvas

210/0051 Marco / Frame

Cuadrado / Square 43 x 43 cm

210/0054 Tela / Canvas

210/0052 Marco / Frame





## MARINE CREATURES

Platos escultóricos de gres que rinden un exquisito homenaje al mar.

Sculptural stoneware plates that pay exquisite homage to the sea.



280/1200  
Blue Fin

10 x 33 cm  
Alt / Height: 16 cm



280/1201  
Octopus

Ø 20 cm  
Alt / Height: 8 cm

280/1202  
Black Sorli

Ø 25 cm  
Alt / Height: 5 cm

3 uds  
pcs



210/0046  
TIKI TIKI  
Vaso Coctel  
Cocktail Cup

3 uds  
pcs

450 ml

Ø 8 cm Alt / Height: 14 cm



My way

280/1204 Blanco / White

280/1213 Negro / Black

Ø 30 cm Alt / Height: 5 cm



## IRATI / AEKI

Producidos localmente con arcilla km 0 de gran dureza, cada pieza se elabora de forma tradicional y manual.  
 Dos colores, dos inspiraciones, para servir cualquier tipo de plato.

IRATI	1 <sup>ud</sup> <sub>pc</sub>	3 <sup>uds</sup> <sub>pcs</sub>	3 <sup>uds</sup> <sub>pcs</sub>	3 <sup>uds</sup> <sub>pcs</sub>
280/1205		280/1206	280/1207	280/1208
Bandeja / Tray		Plato pan Bread plate	Plato llano Plate	Cuenco Bowl
31 x 14 cm Alt / Height: 1,5cm		Ø 15 x 1,5 cm	Ø 25 x 1,5 cm	Ø 20 x 6 cm



AEKI	1 <sup>ud</sup> pc	3 <sup>uds</sup> pcs	3 <sup>uds</sup> pcs	3 <sup>uds</sup> pcs
280/1209	280/1210	280/1211	280/1212	
Bandeja / Tray	Plato pan Bread plate	Plato llano Plate	Cuenco Bowl	
31 x 14 cm Alt / Height: 1,5cm	Ø 15 x 1,5 cm	Ø 25 x 1,5 cm	Ø 20 x 6 cm	

## IRATI / AEKI

Locally made with km. 0 highly durable clay.  
Each piece is handcrafted using traditional methods.  
Two colors, two inspirations, to serve any type of dish.







# TERRA XTREM

Cerámica para uso intensivo, resistente a la humedad y las manchas de aceites o salsas. No mantiene los olores. No usar con fuego directo.

High resistance ceramic. It prevents the humidity absorption as well as oil and sauce stains. Free from accumulation of smells. Do not use with direct fire.

## TIESTO flower pot

12 uds  
pcs

220/3011	XS	Ø 7 cm Alt / Height: 6 cm	125 ml
220/3010	M	Ø 8 cm Alt / Height: 7.5 cm	175 ml
220/3006	L	Ø 10 cm Alt / Height: 9 cm	350 ml
220/3009	XXL	Ø 12 cm Alt / Height: 11 cm	600 ml



6 uds  
pcs  
220/3015  
Tejas XS / Roof Tiles XS

7 x 15 x 3.5 cm



2 uds  
pcs  
220/3012  
Roast & Toast TerraXtrem

19 x 12 x 1.5 cm

220/3008  
Bocadillo TerraXtrem

20 x 9 x 5 cm



Especificaciones  
Specifications

Fabricada con productos 100% naturales  
Made with 100% natural materials

Esmaltes libres de plomo y cadmio  
Lead and cadmium free varnish

Resistentes a microondas, horno, lavavajillas y congelador  
Microwaves, oven, dishwasher and freezer resistant







| Glass Concepts



160/5094

Campana Tesla Ne  
Tesla Cloche Ne

Ø 12 cm  
Alt / Height: 25 cm



160/5110

Estación portátil Tesla  
Portable Tesla Station

13 x 13 cm  
Alt / Height: 4,5 cm  
AC 100-240V 50/60 Hz

160/5091

Base Tesla Red  
Tesla Base Plug-in

13 x 13 cm  
Alt / Height: 4,5 cm  
AC 100-240V 50/60 Hz

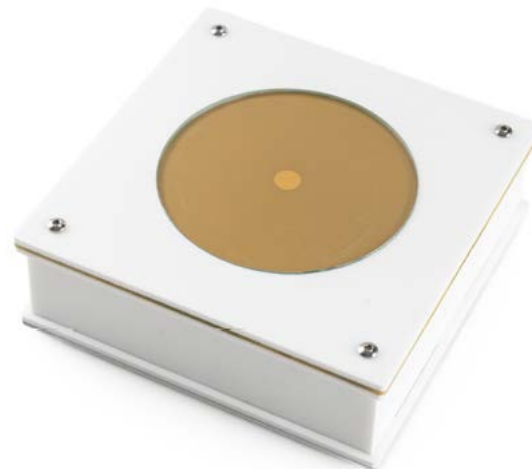

Más info en: / Find out more on:  
[www.100x100barman.com](http://www.100x100barman.com)

100%Barman

160/5092  
High Ball Tesla Ne

Ø 7,5 cm  
Alt / Height: 16 cm

400 ml



160/5093  
Vaso Whisky Tesla Ne  
Tesla Whisky Glass Ne

Ø 9 cm  
Alt / Height: 10 cm

300 ml





## BAR & COCKTAIL

### TESLA BAR & COCKTAIL COLLECTION

Sirva sus cócteles en vasos donde se emplea la tecnología creada por Nikola Tesla en el año 1893.

La electricidad se transmite por el aire de forma inalámbrica gracias a las bobinas Tesla que hay en el interior de nuestras estaciones.

Esta energía acelera las moléculas del gas Neón (Ne) contenido entre las paredes de vidrio de los recipientes.

La electricidad crea en contacto con el gas una fluorescencia de color rojo producida por este tipo de gas inerte. Otros gases como el helio (He), argón (Ar), kriptón (Kr), xenón (Xe) y radón (Rn) emiten otras gamas de color al paso de la electricidad.

Aprovecha esta tecnología para servir tus cócteles y bebidas de forma espectacular incluso utilizando el posavasos personalizado de su bar entre la base y el vaso.

### TESLA BAR & COCKTAIL COLLECTION

Serve your cocktails in glasses using the technology created by Nikola Tesla in 1893.

Electricity is transmitted through the air wirelessly thanks to the Tesla coils inside our stations. This energy accelerates the Neon (Ne) gas molecules contained between the glass walls of the containers. The electricity creates in contact with the gas a red fluorescence produced by this kind of inert gas. Other gases such as Helium (He), Argon (Ar), Krypton (Kr), Xenon (Xe) and Radon (Rn) emit other color ranges when electricity passes through them.

Take advantage of this technology to serve your cocktails and drinks in a spectacular way even using the personalized coaster of your bar between the base and the glass.





400 ml

160/5081  
TODO CORAZON\*

10 x 10 cm  
Alt / Height: 20 cm

160/5038  
SUPER LONG DRINK

400 ml

Ø 10 cm  
Alt / Height: 34 cm



170 ml

160/5107 2 uds  
COPA TWIST MARTINI  
Ø 10,5 cm  
Alt / Height: 20 cm



250 ml

160/5108 2 uds  
COPA TWIST FLAUTA  
Ø 5,5 cm  
Alt / Height: 23 cm

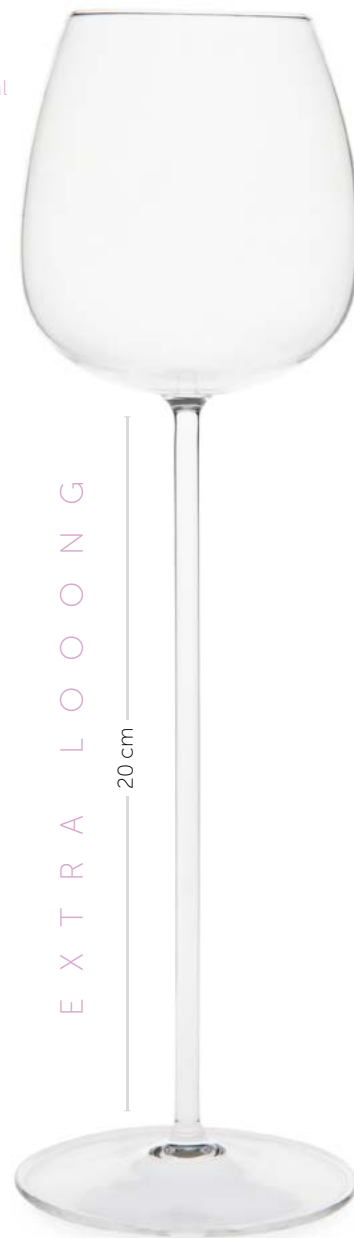

E X T R A L O O N G

20 cm



260 ml

160/5087  
ICE CREAM\*

2 uds  
pcs

Ø 9 cm  
Alt / Height: 20 cm

\*Soporte incluido  
Holder included



160/5042  
SOLERO\*

110 ml

Ø 8 cm  
Alt / Height: 22 cm



Más info en: / Find out more on:  
[www.100x100barman.com](http://www.100x100barman.com)

100% Barman

\*Incluye una pajita de vidrio / Glass straw included.

THE  
ALCHEMIX  
EXTRA-COOL B&B



Más info en: / Find out more on:  
[www.100x100barman.com](http://www.100x100barman.com)

**100% Barman**



**160/5031**  
PIGGY BANK\*

360 ml

15 X 9 cm  
Alt / Height: 9 cm



Fabricados artesanalmente en borosilicato  
Handcrafted with borosilicate in Spain

**160/5035**  
PENGUIN\*

350 ml

11 cm x 10 cm  
Alt / Height: 15 cm



**160/5111**  
ATLAS\*

600 ml

Ø 11 cm Glass  
11 x 17 Alt / Height: 20 cm Kit



160/5024  
ALADDIN

230 ml

20 cm x 7.5 cm  
Alt / Height: 12 cm

160/5036

CINDERELLA PUMPKIN\*

340 ml

19 X 11 cm  
Alt / Height: 17 cm

Desmontable para su limpieza  
Removable for cleaning

160/5030  
SWEET CANDY\*

290 ml

18 x 9 cm  
Alt / Height: 9 cm



THE  
**ALCHEMIX**  
CENTRO-COCKTAIL BAR

Más info en: / Find out more on:  
[www.100x100barman.com](http://www.100x100barman.com)

**100% Barman**

## AIRE DE MAR

Colección inspirada en formas del mar, que recrea corales y animales marinos con la intención de aportar nuevas presentaciones tanto en bebidas como en presentación de platos.

## SEA BREEZE

Inspired by sea shapes, this collection delves into the forms of corals and marine animals with the intention of contributing new presentations in both drinks and presentation of dishes.



160/0089  
GREEN ALGAE

250 ml

Ø 8.5 cm  
Alt / Height: 13 cm

160/0090  
ESTRELLA DE MAR  
STARFISH GLASS

150 ml

Copa / Glass: Ø 8 cm  
Base: Ø 18 cm  
Alt / Height: 11 cm



160/0088  
MINI CORAL REEF

2 uds  
pcs

60 ml

Ø 5 cm  
Alt / Height: 10 cm

160/0120  
OCTOPUS

250 ml

Ø 8.5 cm  
Alt / Height: 13 cm





160/0087  
CORAL REEF

250 ml

Ø 8.5 cm  
Alt / Height: 13 cm



160/6002  
SQUID\*

280 ml

Ø 10 cm  
Alt / Height: 23 cm



## MEDUSA

160/0085    Transparente · Clear

160/0086    Rosa · Pink

Ø 10 cm  
Alt / Height: 16 cm

100 ml



## BIG MEDUSA

160/0130    Transparente · Clear

160/0134    Rosa · Pink

Ø 11 cm  
Alt / Height: 19 cm

200 ml







125 ml  
160/0050  
Erizo / Sea Urchin

Ø ex. 17 cm  
Ø in. 7 cm

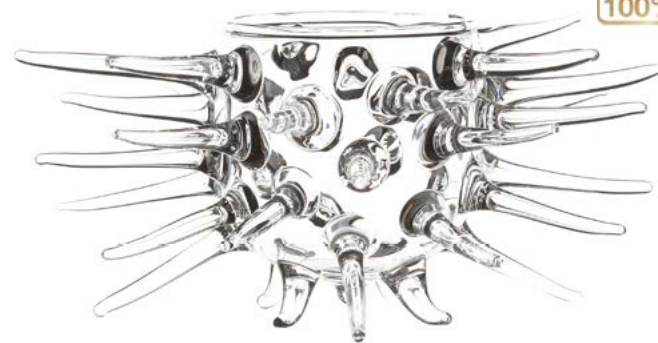

100% Barman

150 ml  
160/0058  
Erizo Alto / Tall Sea Urchin

Ø ex. 15 cm  
Ø in. 5.5 cm

160/5070  
Erizo Gigante\*  
Giant Sea Urchin\*

300 ml

Ø ex. 18 cm  
Ø in. 8.5 cm



150 ml  
160/5101  
Erizo Stand\*  
Stand Sea Urchin\*

2 uds

Ø ex. 14 cm  
Ø in. 7 cm  
Alt / Height 15 cm



\*Copa para beber o comer  
\*Glass for Eat & Drink



**160/5104** 300 ml  
 Erizo Gigante Snow\*  
 Giant Snow Sea Urchin\*  
 Ø ex. 18 cm  
 Ø in. 8.5 cm

Nuestro Erizo con efecto Snow,  
 igual de elegante, igual de espectacular.

Our Snow Effect Urchin, just as elegant,  
 just as spectacular.

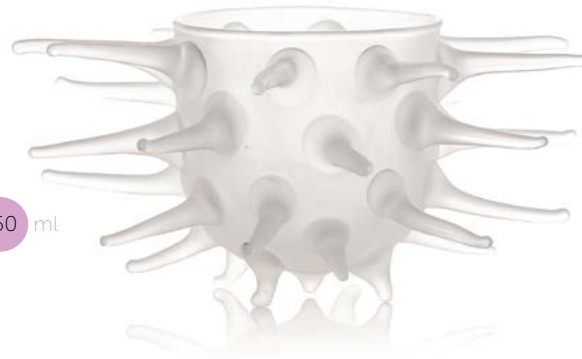

**160/5103** 150 ml  
 Erizo Alto Snow  
 Tall Snow Sea Urchin  
 Ø ex. 15 cm  
 Ø in. 5.5 cm

**160/5102** 125 ml  
 Erizo Snow  
 Snow Sea Urchin  
 Ø ex. 17 cm  
 Ø in. 7 cm



Debido al proceso de fabricación artesanal de las copas y vasos de vidrio borosilicato, las medidas pueden variar ligeramente.  
 Due to the artisanal manufacturing process of our borosilicate glass cups and glasses, sizes may vary slightly.

Más info en: / Find out more on:  
[www.100x100barman.com](http://www.100x100barman.com)

**100% Barman**

**160/0049**  
OSTRA / OYSTER

Ø 12 cm  
Alt / Height: 13 cm



**160/0092**  
CARACOL DE MAR  
SEASHELL

250 ml

8.5 x 16 cm  
Alt / Height: 8.5 cm



**160/0046**  
CAÑAILLA / MUREX SEA SNAIL

21 x 10 cm  
Alt / Height: 12 cm





Fabricados  
artesanalmente en  
borosilicato

Handmade  
Artisanal  
Borosilicate



160/5066  
BLOWFISH

140 ml

18 x 13 cm  
Alt / Height: 8 cm



\*Incluye una pajita de vidrio / Glass straw included.



160/0093  
FUGU\*

250 ml

16 x 10 cm  
Alt / Height: 22 cm



160/0096  
PERA / PEAR\*

400 ml

Ø 11 cm  
Alt / Height: 18 cm



## VEGETALIA COLLECTION

Inspirado en la variedad de formas de la fruta, plantas o flores, estas originales copas despiertan los sentidos y añaden un toque fresco y original a sus bebidas y creaciones.

Inspired by the fruit shapes diversity, this collection wakes up the senses and gives an original fresh touch to your drinks and creations.

Designed with a special hole to fill with ice and a smaller hole for straw. Made of borosilicate withstands hard daily work, blows and scratches.

\*Incluye una pajita de vidrio / Glass straw included.

Agujero especial para  
rellenar el vaso con hielo.  
Special hole to fill with ice.

Ø 3 cm

Pajita de vidrio incluida  
Glass straw included

Agujero para caña  
Hole for straw



160/0094  
APPLE\*

250 ml

Ø 11 cm  
Alt / Height: 14 cm





Fabricados artesanalmente en borosilicato  
Handcrafted with borosilicate in Spain

Más info en: / Find out more on:  
[www.100x100barman.com](http://www.100x100barman.com)

**100% Barman**



160/5021  
BACCHUS\*

330 ml

24 cm x 24 cm  
Alt / Height: 12 cm



160/5064  
BANANA\*

250 ml

23 x 5 cm  
Alt / Height: 10 cm

160/0097  
ANANAS\*

300 ml

Ø 9 cm  
Alt / Height: 23 cm

Ø 3 cm

Agujero especial para  
rellenar con hielo.  
Special hole to fill with ice.

Agujero para caña  
Hole for straw



160/0095  
MANGO\*

400 ml

Ø 11 cm  
Alt / Height: 17 cm



\*Incluyen una pajita de vidrio / Glass straw included.





iPlato tropical!

Tropical plate!

160/0045

PIÑA / PINEAPPLE

60 ml

31 x 9 cm

Alt / Height: 9 cm





160/5027  
BOLETUS\*

370 ml

Ø 9 cm Alt / Height: 14 cm



160/0098  
LACTARIUS\*

150 ml

Ø 15 cm  
Alt / Height: 13 cm

www.rfoodrevolution.com



160/5028  
TOMATO\*

500 ml

Ø 12 cm Alt / Height: 10 cm



Más info en: / Find out more on:  
[www.100x100barman.com](http://www.100x100barman.com)

**100% Barman**

160/0083  
CORNUCOPIA

350 ml

Ø 8 cm  
Alt / Height: 21 cm



Saber más en / Know more on:  
[www.100x100barman.com](http://www.100x100barman.com)

100% Barman

160/0079  
VIKING

350 ml

Ø 7 x 20 cm  
Alt / Height: 19 cm



160/5045  
HEART\*

290 ml

Ø 9 cm  
Alt / Height: 18 cm



THE  
ALCHEMIX  
GASTROCOCKTAIL BAR



160/5085  
THIRST EXTINGUISHER

300 ml

13 x 9 cm · Alt / Height: 19 cm



Fabricados  
artesanalmente en  
borosilicato



Handcrafted  
with  
Borosilicate

160/5025  
MILKSHAKE\*

330 ml

Ø 9.5 cm · Alt / Height: 13.5 cm



\*Incluye una pajita de vidrio / Glass straw included.

Más info en: / Find out more on:  
[www.100x100barman.com](http://www.100x100barman.com)

**100%Barman**



160/5044  
COCKTAIL SHAKER\* 400 ml

Ø 7 cm Alt / Height: 13 cm



160/5086  
AMAZONIC CUP 210 ml

12 x 12 cm Alt / Height: 19 cm





160/5090  
TETRABRICK XL

900 ml

7 x 7 cm Alt / Height: 25 cm



208 – GLASS CONCEPTS



160/5039  
CHRISTMAS BALLS

4 uds  
pcs

240 ml

Ø 9 cm  
Alt / Height: 11 cm

El pack incluye 4 pajitas de vidrio  
The pack contains 4 glass straws.

160/5001  
BRICK

400 ml

9 cm x 10 cm  
Alt / Height: 11 cm



210 ml

310 ml



160/5032  
MOLECULAR\*

17 x 9 cm  
Alt / Height: 9 cm

\*Incluye una pajita de vidrio / Glass straw included.

160/5083  
SKEWER GLASS\*

250 ml

Ø 6 cm Alt / Height: 13 cm



160/5082  
COOKIE BAG\*

250 ml

6 cm x 11 cm  
Alt / Height: 13 cm



160/5084  
PIERCING GLASS\*

250 ml

Ø 6 cm Alt / Height: 13 cm



Más info en: / Find out more on:  
[www.100x100barman.com](http://www.100x100barman.com)

100% Barman



Fly like a Bird! & Drink like a Bird!

200 ml

160/0138  
Fly like a bird\*

15 x 6 cm  
Alt / Height: 18 cm

Pajita incluida  
Straw included

Con alas para  
guarniciones o aperitivos

With wings for garnishes  
or bite-sized appetizers

200 ml

160/0069  
Drink like a bird\*

15 x 6 cm  
Alt / Height: 18 cm

Pajita incluida  
Straw included



\*Incluye una pajita de vidrio / Glass straw included.

Más info en: / Find out more on:  
www.100x100barman.com

**100% Barman**



## SHINE BRIGHT LIKE A DIAMOND!

160/5068  
Diamond\*

2 uds  
pcs

250 ml

10 x 11.5 cm  
Alt / Height: 11.5 cm

Pajita incluida  
Straw included





# FUN SHISHA

## Shisha cocktail individual Personal hookah cocktail

Consiga únicas y sorprendentes sensaciones fumando un delicioso y aromático cocktail. Rellene su vaso de hielo, frutas, hierbas aromáticas, verduras, flores, ... añada una combinación de alcoholes y zumos, y utilizando las piedras de carbón de coco y tabaco aromatizado, podrá preparar infinitos cocktails vaporizados.

Experience the surprising sensation of smoking a delicious and aromatic cocktail. Fill the glass with ice, fruits and aromatic herbs, vegetables, flowers, combination of alcohols and natural juices...

Using scented tobacco and coconut coal you can prepare infinite vaporized cocktails.



160/0115  
Fun Shisha Baby

0.5 L

Ø 12 cm  
Alt / Height: 32 cm

MIX  
tobacco  
&  
fruit



160/0068  
Fun Shisha

1 L

Ø 14 cm  
Alt / Height: 40 cm

Haga de su terraza o zona de fumadores un lugar único y privilegiado  
Turn your terrace or smoking area into a special and privileged place

Saber más en / Know more on:  
[www.100x100barman.com](http://www.100x100barman.com)

100% Barman



# LITHIUM

Disco Luz LED  
LED Light Disc



10 uds  
pcs

100/1017

Lithium disco luz LED  
Lithium LED light disc

Ø 5 cm



Fácil aplicación  
Easy application

160/0019

Kit Smoke & Drink  
Pipa & soporte  
Pipe & Support

100 ml

6 x 16 cm  
Alt / Height: 7 cm



160/0029

Pipa repuesto  
Spare glass pipe

Ø ex. 5,5 cm

160/0067

Pipa Sherlock  
Sherlock Pipe

150 ml

20 x 7 cm  
Alt / Height: 9 cm

Ø ex. 5.5 cm



## CAT CUP & FAT CAT CUP



160/0008 350 ml  
Cat cup

Ø 4 cm  
Alt / Height: 18 cm  
Ø ext. 8 cm

160/0013 200 ml  
Mini Cat cup

Ø 3.2 cm  
Alt / Height: 16 cm  
Ø ext. 6 cm

Copas ideales para servir bebidas con hielo seco o sopas con diferentes temperaturas o texturas. Diseño apto para utilizar con Cocktail Master o herramientas parecidas.

The ideal cup to drink with dry ice or soups of different temperatures and textures. Design suitable for using with Cocktail Master or any similar tool.

Boca ancha para añadir cubitos de hielo o fruta  
Wide mouth to add ice cubes or diced fruits

Ø 5.5 cm



160/0082 300 ml  
Fat Cat Cup

Ø ext. 8 cm

Más info en: / Find out more on:  
[www.100x100barman.com](http://www.100x100barman.com)

**100% Barman**

**160/5033**  
ABSINTHE

250 ml

10 x 9 cm  
Alt / Height: 19 cm



Desmontable para su limpieza / Removable for cleaning

Fabricados  
artesanalmente en  
borosilicato



Handcrafted  
with  
Borosilicate



**160/5034**

POPPY BULB OPIUM

240 ml

8 x 9 cm  
Alt / Height: 22 cm



THE  
**ALCHEMIX**  
GASTROCOCKTAIL BAR



160/0007

Chupito ensayo  
Test shot

Ø 1.2 cm

Alt / Height: 13 cm

4 uds  
pcs

30 ml

### Chupitos creativos Creative shots



Ø 1.2 cm

2 uds  
pcs

160/0015

Chupito doble  
Double shot

Alt / Height: 15 cm

2x30 ml

160/0065

Columbia

Alt / Height: 19 cm

Ø 2.8 cm

2 uds  
pcs

2x80 ml



Ø 2 cm

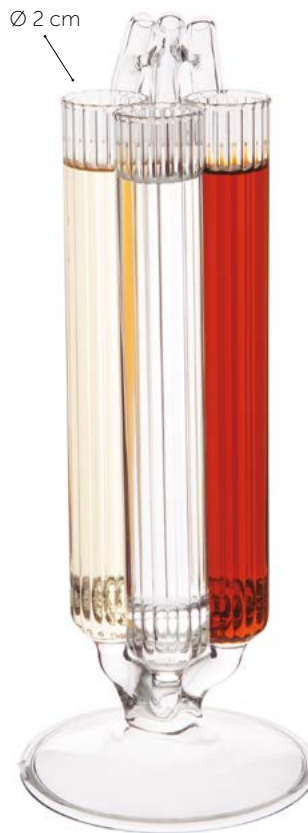

160/0066

Orgasmic

Alt / Height: 19 cm

3x53 ml



160/5065

Chupito XL  
Shot XL

Ø 2.8 cm

Alt / Height: 19 cm

60 ml



BLACKBERRY STEM 2 uds pcs

160/0118 XL Ø 2.5 - Alt / Height: 20 cm 90 ml

160/0119 XS Ø 2.5 - Alt / Height: 15 cm 50 ml



CACTUS

160/5029 XXL Ø 2.2 - Alt / Height: 24 cm 210 ml 1 ud pc

160/0116 XL Ø 3 - Alt / Height: 20 cm 100 ml 2 uds pcs

160/0117 XS Ø 2.2 - Alt / Height: 16 cm 50 ml

Fabricados artesanalmente en borosilicato



Handcrafted with Borosilicate

DRY MARTINI by JAVIER DE LAS MUELAS



160/5079  
MOKA CUP\*

500 ml

9 x 11 cm Alt / Height: 19 cm



160/0059  
RETRO

170 ml

Ø 9 cm  
Alt / Height: 7 cm



160/0102  
RETRO CUP TAIL

170 ml

Ø 9 cm  
Alt / Height: 17 cm



160/0101  
TEA CUP TAIL

200 ml

Ø 8 cm  
Alt / Height: 18 cm

VICTORIAN  
Cocktail Cup



Taza de porcelana  
con pie de vidrio torneado

Porcelain Cup with  
glass handcrafted stem

160/0124  
VICTORIAN COCKTAIL CUP

Ø 9 cm Alt / Height: 13.5 cm

2 uds  
pcs

200 ml



P/68648  
Pinza soporte conos  
Clamp Cone Support



VERSAILLES  
160/0141  
VERSAILLES COCKTAIL CUP

Ø 10,5 cm Alt / Height: 13.5 cm

2 uds  
pcs

200 ml





350 ml

160/0121  
WOOD TRUNK

20 x 13 cm  
Alt / Height: 17 cm

160/0122  
Wood Trunk  
Replacement Glass

Ø 9 cm  
Alt / Height: 8 cm



160/0137  
KIT APPLE WOOD TRUNK

20 x 13 cm  
Alt / Height: 17 cm  
Incluye base de madera y vaso  
Includes wood base and glass

160/0133  
Wood Trunk Apple Glass

Ø 11 cm  
Alt / Height: 14 cm



250 ml

160/5080  
ROLLING CUP

20 x 13 cm  
Alt / Height: 17 cm

250 ml



\* La capacidad de los productos puede variar ligeramente debido a su proceso de fabricación artesanal  
\* The capacity of the products may vary a little due to its handmade manufacturing process

Fabricados  
artesanalmente en  
borosilicato



Handcrafted  
with  
Borosilicate

## SNOWFLAKE

230 ml

160/5049 MARTINI

160/5050 MARGARITA

160/5051 COUPETTE

Ø 11 cm Alt / Height: 19 cm



Base matizada efecto hielo  
Ice-effect matte base



Snowflake  
Collection

# 1/2 COCKTAIL

The perfect aperitif

Degustar cocktails en medias copas,  
¡qué gran idea!

Tasting cocktails in half glasses,  
what a great idea!

2 uds  
pcs

160/0056  
Aperitivo mini  
Mini Appetizer

110 ml

Ø: 8 cm Alt / Height: 7 cm

Probeta  
Test tube cup

2 uds  
pcs

160/0052 Normal

160/0057 Graduada / Graduated

Ø 3 cm  
Alt / Height: 25 cm

60 ml



160/0003  
Aperitivo / Appetizer

110 ml

Ø 8 cm  
Alt / Height: 16 cm





2 uds pcs  
160/0055  
Sour 100 ml

Ø 6 cm  
Alt / Height: 18 cm



2 uds pcs  
160/0051  
Margarita 100 ml

Ø 8 cm  
Alt / Height: 16 cm



2 uds pcs  
160/0084  
Copa Amuse  
Amuse Cup 30 ml

Ø 6.5 cm  
Alt / Height: 13 cm



2 uds pcs  
160/0054  
Passion 100 ml

Ø 8 cm  
Alt / Height: 16 cm



2 uds pcs  
160/0053  
MARTINI 100 ml

Ø 10 cm  
Alt / Height: 16 cm



Saber más en / Know more on:  
[www.100x100barman.com](http://www.100x100barman.com)

**100% Barman**





### SKULL

160/5004  
Skull Glass

6 uds  
pcs  
300 ml

12 cm x 9 cm  
Alt / Height: 9 cm  
Pajita no incluida  
Straw not included

21 cm

13 cm

Saber más en / Know more on:  
[www.100x100barman.com](http://www.100x100barman.com)

100% Barman

Ø 10 cm



### TAKE YOUR TIME

160/0103  
Take your time

300 ml

Mezcle su cocktail  
como un reloj de  
arena

Mix your cocktail  
inside an hourglass



Caña de 20 cm incluida  
20 cm glass straw included



160/5089

Cacito salsera alto  
Sauce scoop high2 uds  
pcs

250 ml

Ø 8 cm Alt / Height: 6 cm



160/5088

Cacito salsera bajo  
Sauce scoop low2 uds  
pcs

150 ml

Ø 8 cm Alt / Height: 4 cm

## Jarrita Boro

### Boro glass jug

A	160/0106	2 Uds/Pcs	Ø 8 cm Alt / Height: 10 cm
B	160/0107	2 Uds/Pcs	Ø 8 cm Alt / Height: 5 cm
C	160/0108	2 Uds/Pcs	Ø 5 cm Alt / Height: 11 cm
D	160/0105	1 Ud/Pc	Ø 8 cm Alt / Height: 15 cm

Jarritas y vasos para salsear, servir jugos, bebidas, jarabes... Fabricados en vidrio borosilicato resistente a lavavajillas.

Basic everlasting jugs and small glasses with pourer designed to serve sauces, juices, drinks, syrups.

Use them while preparing the plates, or directly to serve at the table. Made of borosilicate and dishwasher safe.





Tubo de ensayo gigante  
Giant Test Tube

100/0171 20 Uds/Pcs

100/0172 40 Uds/Pcs

Ø 2.5 x 25 cm

90 ml

\* Tapón no incluido / Cap not included



by  
Javier  
Caballero

6 uds  
pcs

100/0050  
Copa Caballero para tapa cocktail  
Tapa-cocktail "Caballero" cup

Ø 4.5 cm Alt / Height: 10 cm



160/0140  
Fuente Absenta  
Absynt Spring

600 ml

Ø 14,5 cm  
Alt / Height: 37 cm

## PAJITAS DE CRISTAL GLASS STRAWS

Las pajitas de cristal borosilicato son ideales para coctelería molecular. Sienta el frío en los labios!

Borosilicate glass straws are ideal for molecular mixology. Feel the cold on your lips.



**100/1003**  
Escobilla para pajita  
Straw Brush

2 uds  
pcs

**160/0021**  
Pajita recta gruesa  
Straight glass straw

24 uds  
pcs

Ø 0.9 cm Alt / Height: 20 cm

**160/5098**  
Pajitas Ambar  
Ambar Straws

24 uds  
pcs

Ø 0.8 cm Alt / Height: 20 cm

**160/0022**  
Pajita curva gruesa  
Curve glass straw

24 uds  
pcs

Ø 1 cm Alt / Height: 20 cm

**160/0020**  
Pajita mini-cola  
Mini-cola glass straw

36 uds  
pcs

Ø 0.6 cm Alt / Height: 17 cm



**160/0063**  
Brocheta glass XS  
Glass Skewer XS

10 uds  
pcs

10 cm

**160/0064**  
Brocheta glass XL  
Glass Skewer XL

10 uds  
pcs

14 cm







## INFUSION BOWL 4 in 1

Bol de vidrio borosilicato diseñado para acelerar los procesos de saborización de sus bebidas, frutas frescas, etc. Gracias al vacío acelerará la osmosis, integrando todos los sabores en apenas unos minutos, incluso en frío.

Borosilicate glass bowl designed to accelerate the process of flavouring your drinks, fresh fruits, etc. Thanks to the vacuum, you will be able to speed up the process of osmosis. Brewing the flavours in just a few minutes, even in cold infusion.



Realice el vacío con la bomba Ref. 160/0078-1 u otra bomba de extracción, incluso con una eléctrica.

Create the vacuum using our pump Ref. 160/0078-1 or another extraction pump, including electric vacuum pump.



VACUUM INFUSION  
TO ENHANCE SAVOURS

VACUUM  
COCKTAIL  
SHAKER



160/0078  
Infusion Bowl\*

1

Ø 13 cm Alt / Height: 16 cm

El kit contiene/ The kit contains:

Bowl de vidrio borosilicato  
Borosilicate Glass Bowl

Tapón soporte de silicona  
Silicone stopper support

Tapón doble de cierre  
Double sealing plug

Tapón para realizar el vacío  
One plug for vacuum

Pajita de vidrio  
One glass straw

EDIBLE  
COCKTAILS  
PRESENTATIONS



## BORGOÑA

160/0009 con asa / with handle

160/0010 sin asa / without handle

Ø 7,5 cm



350 ml

Ø 10 cm  
Altura / Height: 23 cm

## DRY

160/0001 con asa / with handle

160/0002 sin asa / without handle



60 ml

Ø 11 cm  
Altura / Height: 21 cm

Ø 7,5 cm



325 ml

Ø 8 cm  
Altura / Height: 23 cm

## CHARDONNAY

160/0011 con asa / with handle

160/0012 sin asa / without handle



## BRANCHE GLASS

Vaso para cocktail o destilado sobre base de madera natural de Teka. Su vaso de fino vidrio borosilicato está moldeado uno a uno a semejanza de la rama, encajando en uno de sus nudos portándole estabilidad para su transporte. Todas las ramas y vasos son diferentes tanto en tamaño y forma por lo que confiere a esta colección un carácter único y distinguido.

### LIMITED EDITION!

Glass for cocktail or liqueurs placed on a natural Teka wood base. Its fine borosilicate glass is molded individually following the shape of the branch, fitting into one of its knots to ensure the stability while serving. All branches and vessels are different in both size and shape, giving this collection an unique and exclusive feature.



160/0123  
Branche Glas

6  
uds  
pcs

Ø 22 cm Alt / Height: 11 cm



Caja de madera con cubeta de metacrilato color blanco especialmente diseñada para presentar platos con nieblas de hielo seco. Su cristal superior tiene un agujero lateral para que la niebla quede en la parte superior del plato creando un efecto "bosque".

Wood box with white methacrylate bucket specially designed to present dishes with dry ice fog. The space between the glass tray and the box lets the fog escape from the sides, creating a forest mist effect.



PC/50020

Caja Corfú  
Corfu box

21 x 13 cm  
Altura / Height: 7 cm

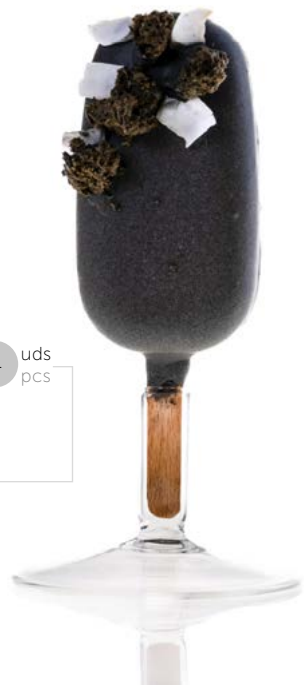

4 uds  
pcs

160/5046  
Soporte Polo  
Popsicle Base

Ø 8 cm  
Alt / Height: 6 cm

PC/50018

Caja Skiathos  
Skiathos box

25 x 18 cm  
Altura / Height: 7 cm



Efecto Bosque  
Forest Effect



## ICE BOWL



160/0004  
Ice bowl 120 ml

Ø extern. 12 cm  
Ø intern. 8,5 cm

Bol hueco fabricado en borosilicato. Permite un relleno de flores, ramas... Ideal para rellenar con agua y congelar, formando un bowl de hielo compacto para servir cualquier sopa fría, helado, tartar, o simplemente llenarlo de humo y aromatizar el plato.

Ice Bowl is a double-walled bowl made of borosilicate glass. Ideal for filling with water and freezing, forming a compact ice bowl for serving any cold soup, ice cream, shellfish salad. Its big size significantly decreases the water loss.



## SIESTA

La copa de vino tumbada fabricada en borosilicato, resiste el fuego del soplete, a fuertes cambios térmicos, al baño en nitrógeno así como a los pequeños golpes de los cubiertos.

Lying wine glass made of Borosilicate. Resists changes, nitrogen bath and also slight cutlery blows.



160/0017  
Copa Siesta / Siesta glass 350 ml

22 cm x Ø 12 cm

Visitenos en:/ Visit us at:  
100x100chef.com



## EGGS



160/0071  
EGGS \*

6 uds  
pcs

65 ml

Ø 5 cm Alt / Height: 6 cm

Acabado mate, resistente a la cocción en el horno o al baño María.  
Matte finish, resistant to oven baking and Bain-marie.

Combina con los siguientes soportes:  
Combines with the following supports:

190/0040, 190/0045, 190/0036, 190/0026, 190/0096



160/0104  
Mini Tartera / Mini Cake Stand

Ø 12 cm  
Alt / Height: 6 cm



160/0038  
Cono glass / Glass Cone

6 uds  
pcs

75 ml

Ø 6 cm  
Alt / Height: 13 cm

CU-CU-RU-CHO  
ICE CREAM CONE

¡El cucurucho tradicional  
reinventado en borosilicato!  
Resiste a la congelación.

Beautiful mini ice cream  
cones made of borosilicate.  
Resistant to freeze.



160/0030  
Cucurucho / Ice cream cone \*

4 uds  
pcs

Ø 4 cm  
Alt / Height: 10 cm

\*Soportes no incluidos / Supports not included

Botellas de cristal borosilicato, resistentes al frío del nitrógeno. Diseñadas para servir jugos, esencias o licores.

Double-layered borosilicate glass bottles. Resistant to cold nitrogen. Made for serving juices, liqueurs or spirits.

2 uds  
pcs

160/0016

Mini aceitera de cristal  
Mini oil bottle

Ø 5,5 cm Alt / Height: 13 cm



## Botella termo Thermal Bottle

160/0023 750 ml Alt / Height: 39 cm

160/0024 500 ml Alt / Height: 30 cm

Ø 8 cm



## DRY-SPOON 6 uds pcs

100/1016 SNOW

100/0016 CLEAR 11 x 2,5 cm

Cuchara individual con doble cámara, ideal para presentar combinaciones de texturas y líquidos sin contacto directo.

Single spoon with double chamber, ideal for presenting combinations of textures and liquids without direct contact.



10 ml



160/0077

Lata Alta Drink Vidrio  
Tall Drink Glass Can

450 ml

Ø 8 cm Alt / Height: 16 cm



## SPACE

Plato reversible en forma esférica transparente.  
Permite ser utilizado como bowl o plato de presentación.  
Serving plate shaped as a spheric transparent disc.  
Double face, can be used as bowl or presentation plate.

160/6001

Plato Space  
Space Plate

Ø 22 x 8 cm



160/0075

Lata redonda vidrio  
Round Glass Can

200 ml

Ø 8 cm Alt / Height: 10 cm



160/0076

Lata oval vidrio  
Oval Glass Can

150 ml

12 x 8 cm  
Alt / Height: 10 cm





# Ovni Tapa

Plato Ovni Tapa, perfecto para presentar cualquier snack o petit four usando nitrógeno, hielo seco combinado con aromas o platos con ahumado, etc.

Ovni Tapas dish. perfect for any snack or petit four using nitrogen, or dry ice combined with spices, smoked dishes.

Plato parte superior | Ø 14 cm  
Top plate

Bol parte inferior | Ø 8 cm  
Bottom bowl



Personalización de tamaño  
Fabricación bajo pedido

Size customization  
Made upon order

160/0025  
OVNI Tapa

2 uds  
pcs

90 ml



BOROSILICATO



**Ovni**

Plato presentación OVNI, perfecto para presentaciones con hielo seco combinado con aromas, platos con ahumado.

UFO presentation plate, perfect for presenting any creation using dry ice combined with spices, smoked dishes.



Personalización de tamaño  
Fabricación bajo pedido

Size customization  
Made upon order



BOROSILICATO

160/0005 XS  
OVNI

Ø 23 cm

160/0006 XL  
OVNI

Ø 28 cm





GLASS CONCEPTS AT:  
www.100x100chef.com

## VULCANO

Plato para ser utilizado con fuego en su interior, perfecto para presentaciones usando el fuego como elemento central.

Gratine unas piezas con caramelo, caliente una copa de cognac o improvise una pequeña cocina en la mesa para saltear unas fresas en la Paella de vidrio ref. 160/0028.

Plate with cavity for fire in the middle. Perfect for presenting any dish using fire as a centerpiece of the plate.

Use for caramel-coating, heating a glass of cognac or transform it into portable table stove where you can toss some strawberries in our glass paella pan, ref. 160/0028.



Personalización de tamaño  
Fabricación bajo pedido

Size customization  
Made upon order



BOROSILICATO

160/0026  
Vulcano Plate XS

Ø 23 cm

160/0027  
Vulcano Plate XL

Ø 28 cm

160/0028  
Paella borosilicato  
Borosilicate Pan

Ø 20 cm





160/0039

Ice Age Plate S

Ø 13/14 cm



160/0040

Ice Age Plate M

Ø 16/17 cm



160/0041

Ice Age Plate L

Ø 20/21 cm



160/0072

Ice Age Lemon

24 x 10 cm



160/0099

Ice Age Plate XL

Ø 25/26 cm

160/0100

Ice Age Plate XXL

Ø 28/30 cm



## ICE AGE

Soportes de presentación o vasos termo fabricados en cristal satinado, ideales para congelar sin esfuerzo ni roturas. Rellenos con una mezcla térmica que se congela sin provocar dilatación ni roturas, podrá servir su plato o bebida con forma de hielo, totalmente compacto y sin generar deshielo o pérdida de agua, y servir cualquier marisco, helado, tartar o licor.

Unique in the market, the Ice Age Plate series has the versatility to meet any serving need. Made with satin glass, it withstands extremely low temperatures without dilatation or breakage due to the thermal mix and the resistance of the glass walls. Serve and keep chilled any dish from seafood, to ice cream or tartare without defrosting or water spilling.

160/1004  
Ice bowl FREEZER

120 ml

Ø 12 cm / Ø 8,5 cm





Fabricados artesanalmente en borosilicato  
Handcrafted with borosilicate in Spain

160/0062  
Chupito FREEZER  
FREEZER Shot Glass

75 ml

Ø 5 cm  
Alt / Height: 12 cm



160/0112  
Iceberg XS

Ø 12 cm  
Alt / Height: 4 cm



160/0114  
Iceberg XL

Ø 14 cm  
Alt / Height: 7 cm



160/0061  
Dry FREEZER Glass

150 ml

Ø 9 cm  
Alt / Height: 12 cm



## LISBOA

Infusionador de vidrio borosilicato para alimentos, inspirado en las tradicionales cafeteras portuguesas. Resistente a altas temperaturas, es ideal para infusionar hierbas aromáticas, raíces y obtener caldos u otras elaboraciones directamente en la mesa a la vista del cliente. Añada un elemento coreográfico a su servicio de mesa. Fácil de utilización, las piezas de recambio están disponibles en nuestro catálogo.

Infuser for food inspired by traditional Portuguese coffee makers, made of borosilicate glass resistant to high temperatures. Use it to infuse aromatic herbs, roots and obtain broths or other elaborations directly on the table in front of the customer. Add a choreographic element to your table service. Easy to use, spare parts are available in our catalog.

TAMBIÉN PARA INFUSIONES CON DRY ICE  
ALSO FOR DRY ICE COLD INFUSIONS



30/0043

Infusionador de sifón Lisboa  
Vacuum Brewer Lisboa

500 ml

Ø 12 cm

Alt / Height: 36 cm



30/0042

Microlador - Colador Inox  
Microlator - Stainless Steel Colander

Ø 12 cm Alt / Height: 9 cm

Colador con malla de acero inoxidable de 400 micras. Filtra posas o residuos. Base diseñada para encajarse en vasos, copas y tazas. Realice infusiones frías y calientes à la minute. Filtra posos de vino.

Strainer with stainless steel mesh. Designed to filter the smallest particules. Base designed to fit into glasses, cups and mugs. Make hot and cold infusions à la minute. Filters wine sediments.



60/0020

Ice Ball Press Ø 8 cm

60/0021

Ice Ball Press Ø 6 cm

Prensa de aluminio macizo para producir esferas de hielo perfectas a partir de un bloque de hielo. Disponible en dos diferentes diámetros.

Solid aluminum press to produce perfect ice spheres from a block of ice. Available in two different diameters.



Ø  
6-8  
cm

Perfectas esferas de hielo  
Perfect ice cube spheres





Más info en: / Find out more on:  
[www.100x100barman.com](http://www.100x100barman.com)

**100% Barman**

## Dry Martini "Olive" Ice Cube Stick FREEZER

Pinchos refrigerantes con forma de aceituna o cubito, para enfriar sus cockteles de forma elegante.

Rellenos de una mezcla térmica, que se congela sin provocar dilatación ni rotura del vidrio.

Cool your drinks with elegance, with our cool pinchos in shape of olive or ice cube.

The pincho is filled with a special thermal-fluid which can get freeze without to expand and break the glass.

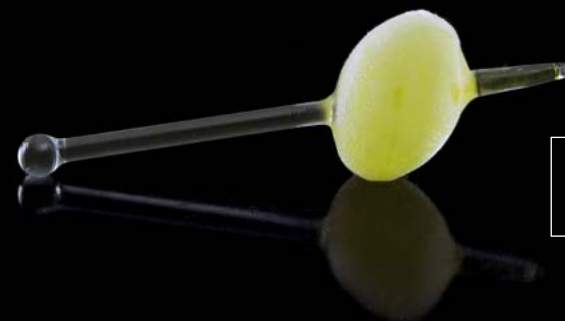

2 uds  
pcs

160/0081  
Ice Cube Stick

Largo / Long: 16 cm



3.5 cm



3 uds  
pcs

160/0080  
Dry Martini Freezer "Olive"

Largo / Long: 10 cm



## MIX & DRY

Juego de cuchara mezcladora y agitador de hielo  
Set of borosilicate bar spoon and dry ice stirrer

Gasifique y añada cierto glamour a su vaso mezclador incorporando niebla con hielo seco. También puede utilizarse como infusor añadiendo hierbas, pieles de cítricos, flores o liofilizados, dando toques de sabor y color a sus combinados.

Add gas and some glamour to your cocktail creating fog with dry ice. It can infuse by adding herbs, citrus peels, flowers, lyophilized products, giving touches of flavor and color to any cocktail.



160/0111  
Mix & Dry Kit

Largo / Long: 29 cm  
Vaso no incluido  
Glass not included



160/0110  
Vaso Gallone  
Gallon Mixing Glass

2.5 L

Vaso mezclador gigante especial eventos  
Giant mixing glass for special events

For special events use our giant mixing glass



2.5 L





240/0025  
BOILING XL  
Blanco / White

Ø 26 x 2 cm



240/0026  
BOILING XS  
Blanco / White

Ø 20 x 2 cm

OVAL Blanco / White

240/0033 XL 30 x 12 x 2 cm

240/0034 XS 19 x 11 x 2 cm



Minimiza  
el ruido de los cubiertos

OVAL Negro / Black

240/0035 XL 30 x 12 x 2 cm

240/0036 XS 19 x 11 x 2 cm



Cutlery Sound Reducer



## LAVA, BOILING & MORE

Platos y bandejas fabricados con vidrio Opal mediante la técnica de moldeo por fusión. Disponibles en color negro o blanco con textura suave mate.

Ideal para resaltar elaboraciones de colores intensos.

A pesar de su ligereza, ofrecen gran resistencia al trabajo diario.

Dishes and trays made of Opal glass, using the fusing moulding technique.

Available in black or white, with a smooth matt or glossy texture depending on the model. Ideal for highlighting elaborations of intense colours.

Despite their lightness, they offer great resistance to daily work.



240/0028  
BOILING XS  
Negro / Black

Ø 20 x 2 cm



240/0027  
BOILING XL  
Negro / Black

Ø 26 x 2 cm



240/3003  
LAVA XL

Ø 27 cm



240/3002  
LAVA XS

Ø 17 cm

240/3001  
LAVA  
Plato hondo / Soup plate

Ø 22 cm



LAVA BOWL    Ø 26 x 5,5 cm

240/3005

Blanco / White

240/3004

Negro / Black





ZIG ZAG 21 x 9 x 1.5 cm

240/0029 Blanco / White

240/0030 Negro / Black

240/0031  
NAPKIN  
Blanco / White

22 x 18 x 2 cm



240/0032  
NAPKIN  
Negro / Black

22 x 18 x 2 cm



## MADREPERLA

Platos de vidrio con acabado nácar

Glass plates with pearl finish

2 uds  
pcs

240/2004  
Pearl plate

14 x 14 cm



2 uds  
pcs

240/2001  
Plato navaja  
Razor Shell Plate

26 x 4.5 cm  
Alt / Height: 1.5 cm



240/0056  
Plato Bambú  
Bamboo Plate

26 x 9 cm  
Alt / Height: 4 cm

## BAMBOO & ALABASTRO

Platos ligeros cómo el vidrio, y elegantes como esculturas

Dishes as light as glass, and elegant as sculptures

240/0055  
Bol Alabastro  
Alabaster Bowl

Ø 21 cm Alt / Height: 4 cm



240/0057  
Plato Alabastro  
Alabaster Plate

Ø 25 cm Alt / Height: 3 cm





## BLUE CARIBBEAN & WAKAME



Purpurina vitrica reflectante, un toque luminico y vivo para representar una lámina de alga Nori. Shiny sparkles glass plate, a luminous and lively touch that represents a Nori sheet.

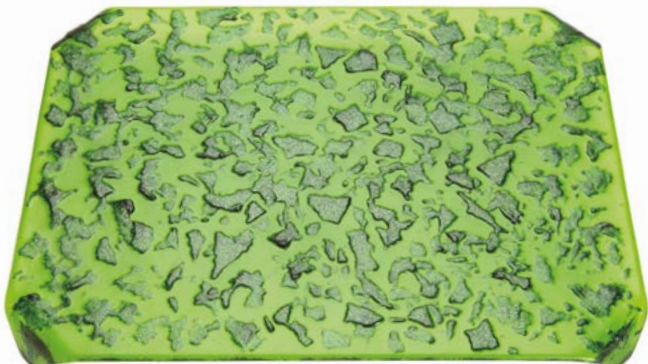

240/0001  
NORI  
22 x 16 cm

240/0020  
Wakame Bowl

Ø 15 cm

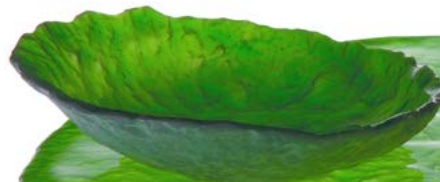

240/0019  
Wakame Plate S

Ø 17 cm

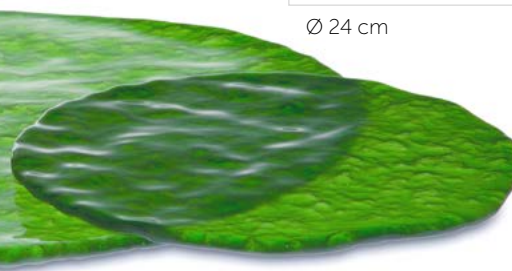

240/0018  
Wakame Plate M

Ø 24 cm

240/0017  
Wakame Plate L

Ø 29 cm

240/1020  
Blue Caribbean Bowl

Ø 15 cm



240/1019  
Blue Caribbean S

Ø 17 cm



240/1018  
Blue Caribbean M

Ø 24 cm

240/1017  
Blue Caribbean L

Ø 29 cm



Fabricados con vidrio Opal mediante la técnica de moldeado por fusión. Acabados mates y aterciopelados. Gran resistencia al trabajo diario a pesar de su ligereza, tan sólo 400 g.



STUCCO NEGRO  
BLACK STUCCO

240/0004  
Stucco negro  
Black Stucco

Ø 27 cm

Made with Opal glass, using fusion moulding technique. Matte and velvety finish with minimalist design. Plates highly resistant to daily work, despite their light weight of only 400 g.

WAVE

240/0002  
Wave

Ø 27 cm

240/0003  
Stucco blanco  
White Stucco

STUCCO BLANCO  
WHITE STUCCO

Ø 27 cm



EFFECTO IRIDISCENTE  
IRIDESCENT EFFECT



NEBULOSA  
NEBULA

240/0052 XS Ø 18 cm Alt / Height: 3 cm

240/0053 M Ø 21 cm Alt / Height: 3 cm

240/0054 XL Ø 26 cm Alt / Height: 5.5 cm

El color interior cambia con la incidencia de la luz  
The interior color changes with the incidence of light

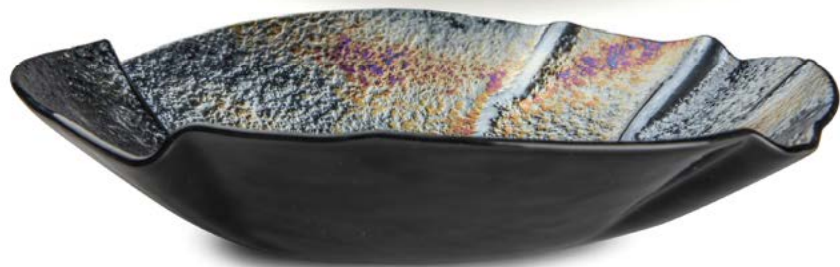

## CADAQUÉS

Platos de vidrio diseñados por el mar

Glass plates shaped by the sea



	XXS 9 x 7 cm	XS 14 x 10 cm	XL 22 x 14 cm	XXL 25 x 20 cm
	4 uds pcs	2 uds pcs	2 uds pcs	1 uds pcs
Azul / Blue	240/0068	240/0010	240/0006	240/0062
Verde / Green	240/0069	240/0011	240/0007	240/0063
Blanco / White	240/0070	240/0012	240/0008	240/0064

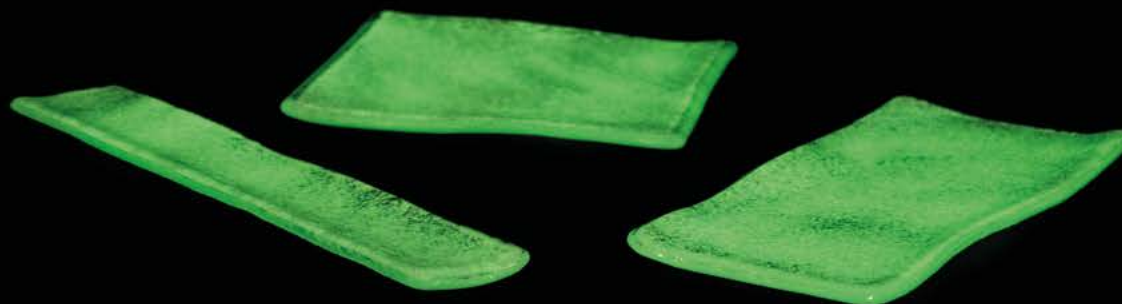

## FLUORESCENT

### PHOSPHORUS

Exclusive glass plates filled with fluorite. Transform your table into a dreamlike stage with the fluorescent effect these plates provide. After a brief exposure to light, either natural or artificial, these plates will come to life under subdued lighting, creating a dazzling glow that lasts for minutes. The best part is, you don't need ultraviolet or blacklight to enjoy this fascinating experience.

### PHOSPHORUS 3 uds pcs

240/0065	Peti	5,5 x 30 cm Alt / Height: 1 cm
240/0066	Plato / Plate	18 x 18 cm Alt / Height: 1 cm
240/0067	Bandeja / Tray	12 x 26 cm Alt / Height: 1 cm

### PHOSPHORUS

Exclusivos platos de vidrio con relleno de fluorita. Convierta su mesa en un escenario de ensueño con el efecto fluorescente que estos platos ofrecen. Después de una breve exposición a la luz, ya sea natural o artificial, estos platos cobrarán vida bajo una iluminación tenue, creando un deslumbrante resplandor propio que durará minutos. Lo mejor de todo es que no se requiere luz ultravioleta o negra para disfrutar de esta experiencia fascinante.

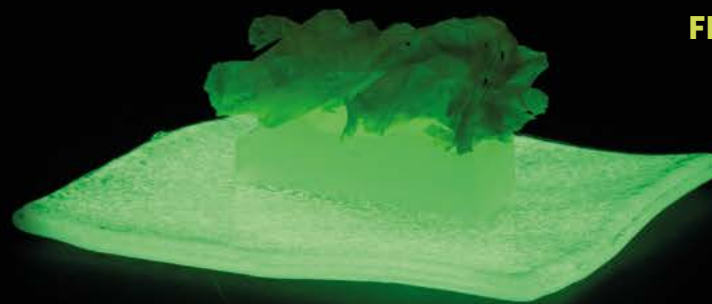

## FLUORESCENTE





Cuchara producida artesanalmente en vidrio.  
Para los paladares más exigentes.

Tongue-shaped spoon, handmade in glass.  
For the most demanding palates.

240/0041  
Lengua / Glass Tongue

10 x 5 cm  
Alt / Height: 2 cm

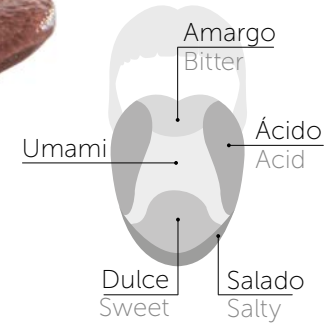

## CUCHARAS DEGUSTACIÓN

### PRESENTATION SPOONS

Pétalos de rosa moldeados en vidrio coloreado.  
Sutiles, ligeros y elegantes, no requieren el uso de cubiertos.

Rose petals moulded in coloured glass.  
Subtle, light and elegant, they do not require the use of cutlery.

ROSES 6 uds  
pcs

240/0014 Rojo / Red

240/0015 Blanco / White

240/0016 Rosado / Rosy

7 x 5 cm Alt / Height: 3 cm



2 uds  
pcs  
240/0074  
Hikamura L

18 x 11 cm Alt / Height: 2 cm



2 uds  
pcs  
240/0073  
Hikamura S

18 x 6 cm Alt / Height: 2 cm



2 uds  
pcs  
240/0076  
Bandeja 2 ostras  
2 Oysters tray

18 x 13 cm Alt / Height: 3 cm



240/0072  
Bandeja 6 ostras  
6 Oysters tray

Ø 26 cm Alt / Height: 4 cm



240/0071  
Bandeja 12 ostras  
12 Oysters tray

Ø 38 cm Alt / Height: 4 cm



De vidrio transparente para rellenar con hielo pilé. Son apilables y reversibles para otros tipos de presentaciones. No gotean ni mojan el mantel.

Clear glass trays for filling with crushed ice. They are stackable and reversible for other types of presentations. Do not drip or wet the tablecloth.

## PLATO-BOTELLA BOTTLE-PLATES

Medias botellas con el corte pulido y base rebajada que le confiere una buena estabilidad.

Ideal para presentar platos o postres con vino, cava o licor como ingrediente.

Half bottles with polished cut and lowered base that gives it good stability.

Ideal for presenting dishes or desserts with champagne, wine or liquor as ingredient.



6 uds  
pcs

100/0140  
Plato hondo cava verde\*  
Deep Champagne Plate Green\*

500 ml

30 x 8 cm - Alt / Height: 6 cm

2 uds  
pcs

100/0188  
Vaso cocktail cava  
Cocktail glass cava

330 ml

Ø7 cm - Alt / Height: 18 cm



6 uds  
pcs

100/0088  
Plato botella cava MINI  
MINI Champagne Plate

130 ml

24 x 7 cm - Alt / Height: 4 cm



6 uds  
pcs

100/0049  
Plato botella cava  
Champagne Plate

250 ml

30 x 8 cm - Alt / Height: 4 cm



3 uds  
pcs

100/0190  
Plato cava para corcho  
Cava cork plate

15 x 6 cm Alt / Height: 2 cm

3 uds  
pcs

100/0189  
Plato cava snack  
Snack cava plate

19 x 7 cm Alt / Height: 2 cm



100/0191  
Plato botella anís  
Anisette bottle plate

6 uds  
pcs

300 ml

30 x 8 cm Alt / Height: 4 cm



100/0087  
Plato-botella Burdeos  
Bordeaux plate

6 uds  
pcs

100 ml

30 x 8 cm Alt / Height: 3 cm



# advance collection

“Mise-en-scène” de platos  
gastronómicos  
Mise en scène for gastronomic  
masterpieces

Consiste en un soporte transparente (escenario) y un plato acoplable disponible en diferentes modelos. La base se utiliza como escenario donde ambientar la creación del Chef, combinando con cada plato un escenario con naturaleza viva, hojas secas, flores, hierbas aromáticas... Aporte aromas y efectos visuales como niebla de hielo seco, humo o luz. Un mismo escenario puede ofrecer infinitas posibilidades a la hora de presentar cada plato, dependiendo de la imaginación de cada profesional.

A transparent support is the stage that holds a presentation plate available in different models. The glass base is used as a scene where the Chef's creation reveals, marrying each dish with vivid nature, dry leaves, flowers or aromatic herbs. Add scents and visual effects such as dry ice fog, smoke and light. One scenario turns into infinite possibilities when presenting each dish, depending on your imagination.



Fabricado artesanalmente en borosilicato  
Borosilicate handcrafted in Spain

160/0125  
Advance Escenario  
Advance Stage

Ø 28 cm  
Alt / Height: 8.5 cm





BLACK MOON



GALAXY



VENUS



## ADVANCE

PLATOS DE MÁRMOL / MARBLE PLATES

190/0083

Black Moon

190/0084

Galaxy

190/0085

Venus

Ø 17 cm

Personalice sus platos tanto en tipo de mármol como diseño  
Customise your plates in both marble type and design

## ADVANCE

PLATOS DE VIDRIO OPAL / OPAL GLASS PLATES

240/0021

Pearl

240/0022

Tiger's Eyes

3 uds  
pcs

240/0023

Emerald

240/0024

Obsidian

Ø 17 cm



PEARL



TIGER'S EYES

EMERALD



OBSIDIAN



## ADVANCE R-FILL

Le hemos dado la vuelta a nuestros platos Advance. ¡Literalmente!  
Esta nueva versión cuenta con la base y orificio de llenado bajo el plato, permitiendo el emplatado directamente sobre el cristal. Conseguimos una integración visual perfecta entre el plato y el relleno elegido.

We have turned our Advance plates upside down. Literally!  
This new version features a base and filling hole beneath the plate, allowing direct plating onto the glass. We achieve a perfect visual integration between the plate and the chosen filling.



150 ml

160/5096

R-fill Bowl

Ø 14 cm Alt / Height: 8 cm

160/5076

R-fill Glass

Ø 14 cm Alt / Height: 12 cm



300 ml

## HOW TO USE R-FILL?



### CORCHO R-FILL / R-FILL CORK

160/5105	Big (160/5074 - 160/5075)	Ø 9,8 cm
160/5106	Small (160/5096 - 160/5076)	Ø 7,5 cm





160/5074  
R-fill Deep  
Ø 25 cm  
Alt / Height: 10,5 cm



160/5075  
R-fill Plate  
Ø 22,5 cm  
Alt / Height: 5,5 cm



1 Corcho incluido en la compra de cada plato, vaso o bowl.  
1 Cork included with the purchase of each plate, glass, or bowl.







Hyperrealism  
Más allá de la realidad  
Beyond reality

## HIPERREALISMO HYPERREALISM

Piezas originales, íntegramente fabricadas en resina y pintadas a mano con pinturas aptas al contacto alimentario. Moldes personalizables, exclusivos a demanda y en pequeñas series.

Original pieces with unique design. Thermoformed with acrylic resin: a low-density and light material.

Moulds that can be customised, unrepeatable on demand and in small series.



300/0031  
Baya cacao oro  
Gold cocoa bean

26 x 12 cm  
Altura / Height: 11 cm



300/0026  
Helado nata  
Icecream Sandwich

20 x 10 cm  
Altura / Height: 6 cm



300/0028  
Baya cacao  
Cocoa bean

26 x 12 cm  
Altura / Height: 11 cm



300/0027  
Grano de café  
Coffe bean

19 x 11 cm  
Altura / Height: 7 cm





PERSONALIZABLES  
CUSTOMIZABLES

a partir de 15 uds  
from 15 pcs

Cada pieza se puede producir en diferentes colores según demanda.

All shapes are customizable in different colors.



## PORKY SILVER

300/0007 22 x 10 cm - Altura / Height: 9 cm

300/0022 38 x 18 cm - Altura / Height: 15 cm



300/0023  
Bandeja Porky Rosa  
Pink Porky Tray

48 x 20 cm  
Altura / Height: 18 cm



300/0030  
Lingote oro  
Gold ingot

21 x 10 cm  
Altura / Height: 5 cm





## BOWL TOMATO

300/0019 Verde · Green

300/0020 Rojo · Red

Ø 12 cm

Altura / Height: 12 cm 250 ml



300/0017

Soporte taco maíz  
Corn Taco Support

27 x 9 cm

Altura / Height: 7 cm



300/0018

Bowl manzana roja  
Red Apple Bowl

250 ml

Ø 12 cm

Altura / Height: 12 cm



300/0021

Bowl naranja  
Orange Bowl

250 ml

13 x 12 cm

Altura / Height: 13 cm

300/0024

Soporte taco mex  
Mex Taco Support

Ø 13.5 cm

Altura / Height: 5.5 cm



300/0009  
OCTOPUS SLICE

Ø 24 cm  
Altura / Height: 5 cm



300/0001  
BOGAVANTE / LOBSTER

35 x 20 cm  
Altura / Height: 6 cm



300/0016  
Soporte hoja pez  
Fish Leaf Support

34 x 8 cm  
Altura / Height: 6 cm



300/0011  
TUNA VERTEBRA

21 x 8 cm  
Altura / Height: 6 cm



300/0004  
Hoja verde primavera  
Leaf Spring Green

19 x 14 cm Alt / Height: 3 cm



300/0005  
Hoja roja otoño  
Leaf Fall Red

19 x 14 cm Alt / Height: 3 cm



300/0008  
POTATO PLATE

250 ml

14 x 9 cm  
Altura / Height: 6 cm



300/0025  
POTATO BOWL

500 ml

20 x 15 cm  
Altura / Height: 10 cm



300/0010  
SERVILLETA / NAPKIN BOWL

13 x 13 cm  
Altura / Height: 7 cm



300/0002  
CHOCOLAT PLATE

Ø ex.10 cm - Ø int.9 cm  
Altura / Height: 12 cm



300/0006  
MILK SPLASH PLATE

11 x 11 cm  
Altura / Height: 8 cm  
Ø int. 5 cm



300/0029  
LEMON SORBET

240 ml

Ø 10 cm  
Altura / Height: 11 cm



Posibilidad de etiqueta personalizada  
Option to add a custom label



300/0003  
COCO LOCO CUP

250 ml

Ø 10 cm  
Altura / Height: 13 cm







## WHAT CAN WE DO FOR YOU?

Haga realidad su propio diseño e Instagrameables los platos de su carta. El límite será su imaginación.  
Bring your own design to life and make your menu's dishes Instagrammable. The only limit is your imagination.

## ¿QUÉ PODEMOS HACER POR TI?



# TropicCups



300/0013  
FRESA / STRAWBERRY 300 ml

Ø 13 cm Altura / Height: 18 cm



300/0013  
FRESA / STRAWBERRY 300 ml

Ø 13 cm Altura / Height: 18 cm



300/0012  
PLÁTANO / BANANA 120 ml

16 X 17 cm  
Altura / Height: 19 cm

300/0014  
PIÑA / PINEAPPLE 300 ml

Ø 11 cm Altura / Height: 18 cm



300/0015  
MORA / BLACKBERRY 300 ml

Ø 13 cm Altura / Height: 18 cm









## Table top

Servicio de mesa premium  
Premium tableware



## KODAI



2019 WINNER  
**EUROPEAN  
PRODUCT  
DESIGN  
AWARD**

Para un ritual con personalidad que nos transporta al mundo asiático. Kodai es una cubertería con diseño original y de calidad para completar los platos más creativos.

De acabado sofisticado, dispone de una pieza distinta para cada plato. Realizada en Inox 18% Nickel Free / 3 mm / Acabado Vintage

For a ritual with personality that transports us to the Asian world. Kodai is a cutlery with original design and quality to complete the most creative dishes. With a sophisticated finish, it features a distinct piece for each dish.

Made in Stainless Steel 18% Nickel Free / 3 mm / Vintage Finish



## KODAI VINTAGE GOLD



## KODAI VINTAGE

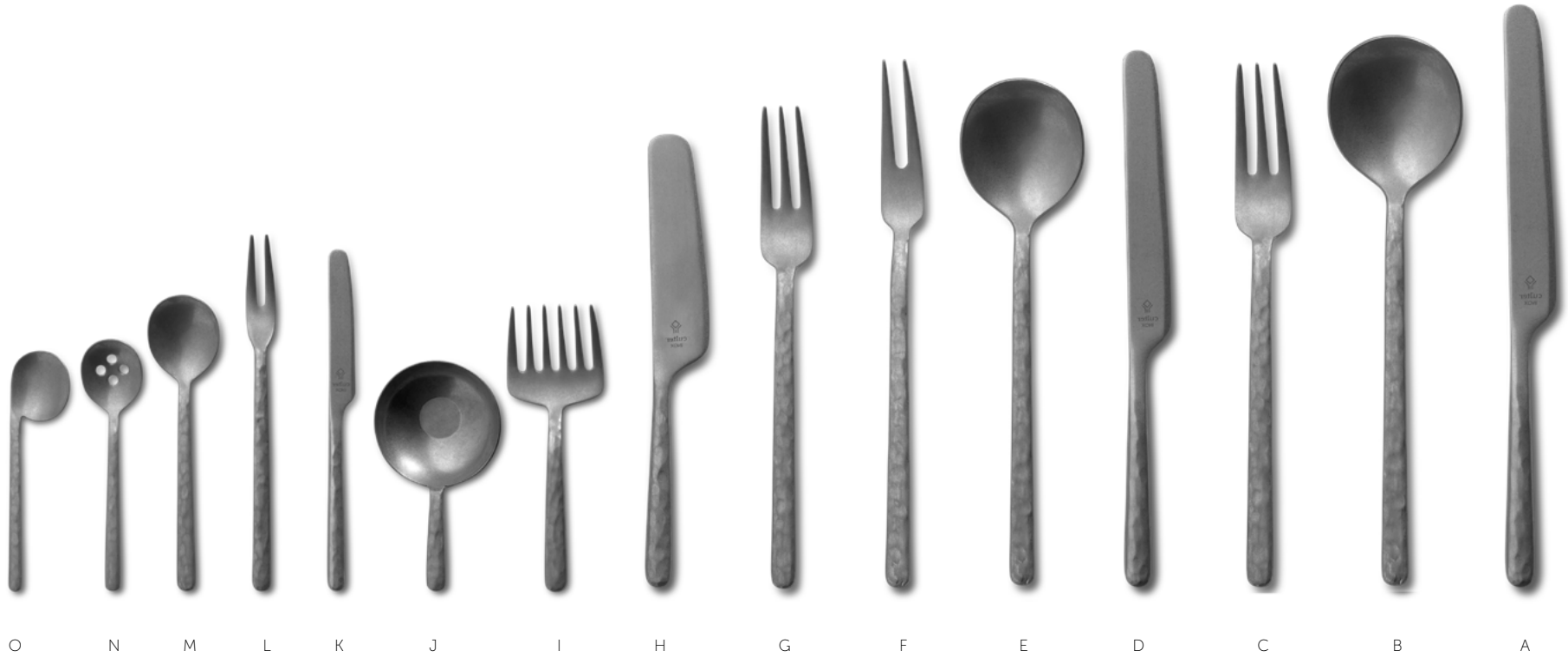

## KODAI VINTAGE BLACK

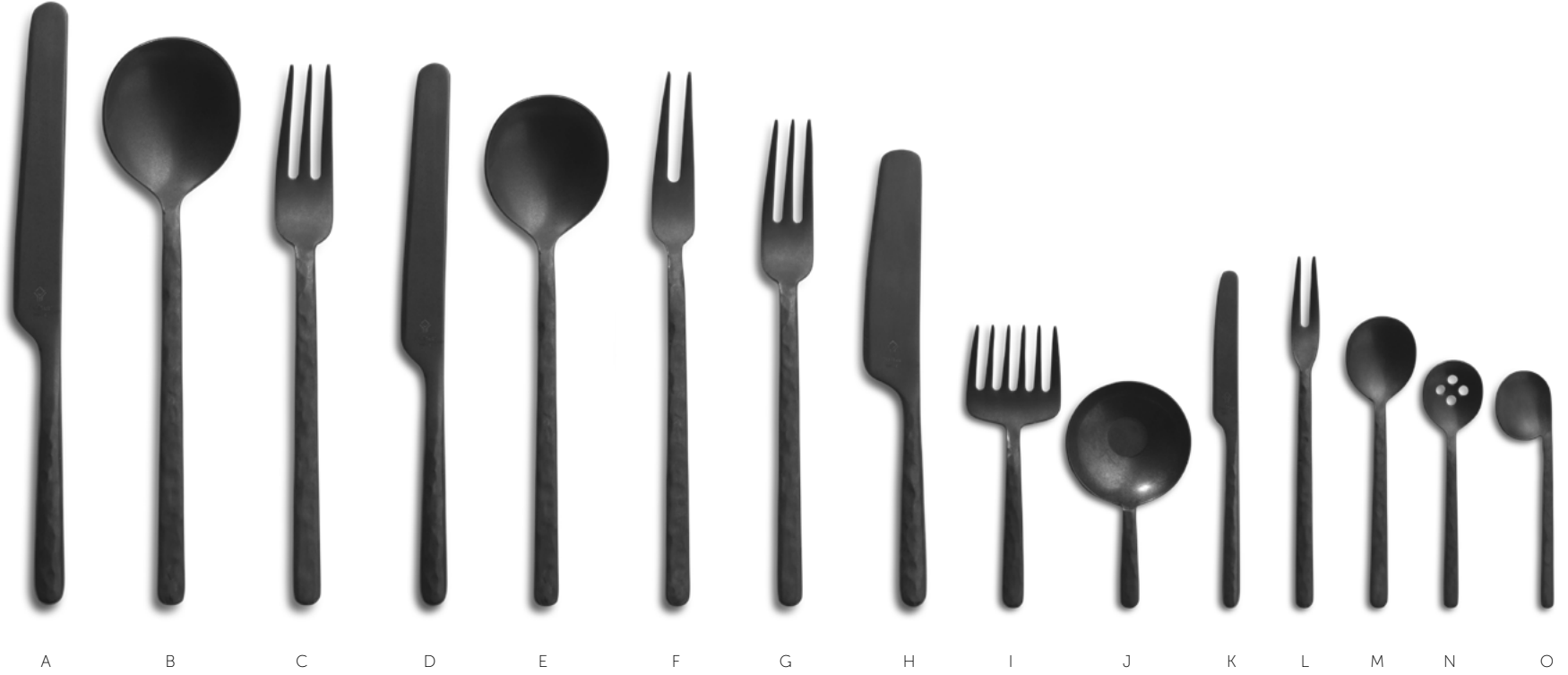



## KODAI



	GOLD	VINTAGE	BLACK		◆cm	✕cm
A	C7278	C7276	C7277	Cuchillo mesa XL / Table knife XL	21.2	0.6
B	C7281	C7279	C7280	Cuchara mesa XL / Table spoon XL	19	0.3
C	C7287	C7285	C7286	Tenedor mesa 3 puas XL / Table fork 3 prongs XL	19.5	0.3
D	C7081	C6943	C7069	Cuchillo mesa / Table knife	18.3	0.6
E	C7082	C6944	C7070	Cuchara mesa / Table spoon	17	0.25
F	C7083	C6945	C7071	Tenedor mesa 2 puas / Table fork 2 prongs	17.9	0.25
G	C7084	C6946	C7072	Tenedor mesa 3 puas / Table fork 3 prongs	16.3	0.25
H	C7085	C6947	C7073	Cuchillo mantequilla / Butter knife	15.5	0.6
I	C7092	C6954	C7080	Tenedor rastrillo / Wide fork	11.3	0.25
J	C7091	C6953	C7079	Cuchara arroz / Rice spoon	9	0.25
K	C7086	C6948	C7074	Cuchillo lunch / Cake knife	13.3	0.6
L	C7087	C6949	C7075	Tenedor lunch / Cake fork	13.8	0.2
M	C7088	C6950	C7076	Cuchara café / Coffee spoon	11.54	0.17
N	C7090	C6952	C7078	Cuchara moka / Moka spoon	9.75	0.17
O	C7089	C6951	C7077	Cuchara side / Side spoon	9.35	0.2

60 uds  
pcs

## MINI KODAI Porcelana MINI KODAI Porcelain

Descubre la elegancia y durabilidad de las miniaturas de porcelana blanco mate de Mini Kodai, diseñadas a la perfección para complementar la cubertería de la misma colección. La vajilla perfecta para servir aperitivos y tapas.

La porcelana de Mini Kodai ha sido especialmente elaborada para soportar un uso intenso. Gracias a un proceso de cocción de dos tiempos a más de 1200°C, hemos creado un material ultra resistente y suave al tacto.

Experience the elegance and durability of Mini Kodai's white matte porcelain miniatures, designed to perfectly match the cutlery in the same collection. It's the perfect tableware for serving appetizers and tapas.

The porcelain used by Mini Kodai has been specially crafted to withstand heavy use. By firing it in two stages at temperatures above 1200°C, we've created a material that's both ultra-resistant and smooth to the touch.



Mini caja  
Mini box

6 uds  
pcs

C7622 S 6 x 6 cm - Altura / Height: 5.5 cm

C7621 M 8 x 12 cm - Altura / Height: 7 cm



C7623  
Mini colador  
Mini colander

6 uds  
pcs

Ø 10 cm  
Altura / Height: 6 cm



C7624  
Mini parrilla  
Mini grill plate

6 uds  
pcs

Ø 9 cm  
Altura / Height: 2 cm



C7629  
Mini bandeja  
Mini tray

6 uds  
pcs

8 x 15.5 cm  
Altura / Height: 1 cm





C7625

Mini vaso  
Mini cup

Ø 5 cm  
Alt / Height: 4 cm

6 uds  
pcs



C7626

Mini tarrina  
Mini ramekin

Ø 8 cm  
Alt / Height: 2.5 cm

6 uds  
pcs



C7627

Mini sartén  
Mini pan

Ø 9 cm  
Alt / Height: 2.5 cm  
Longitud / Large: 14 cm

6 uds  
pcs



C7628

Mini cazuela  
Mini gratin plate

Ø 9 cm  
Alt / Height: 2.5 cm  
Longitud / Large: 14 cm

6 uds  
pcs

250 ml



C7630

Mini olla  
Mini soup tureen

Ø 10 cm  
Alt / Height: 9 cm  
Longitud / Large: 14 cm

6 uds  
pcs



## LAB

Descubre nuestra colección de cubertería con líneas puras y minimalistas. ¡Es perfecta para acompañar aperitivos, tapas, cócteles, arroces...!

Fabricada en acero inoxidable 18/10, lo que garantiza su calidad y durabilidad. LAB cuenta con múltiples piezas, convirtiéndose en una elección versátil para cualquier tipo de evento. Disponible en 4 acabados.

Discover our collection of cutlery with pure and minimalist lines. It's perfect for accompanying appetizers, tapas, cocktails, and rice dishes!

It's made of 18/10 stainless steel, ensuring its quality and durability. LAB has multiple pieces, making it a versatile and elegant choice for any type of event. Available in 4 finishes.





## LAB MIRROR

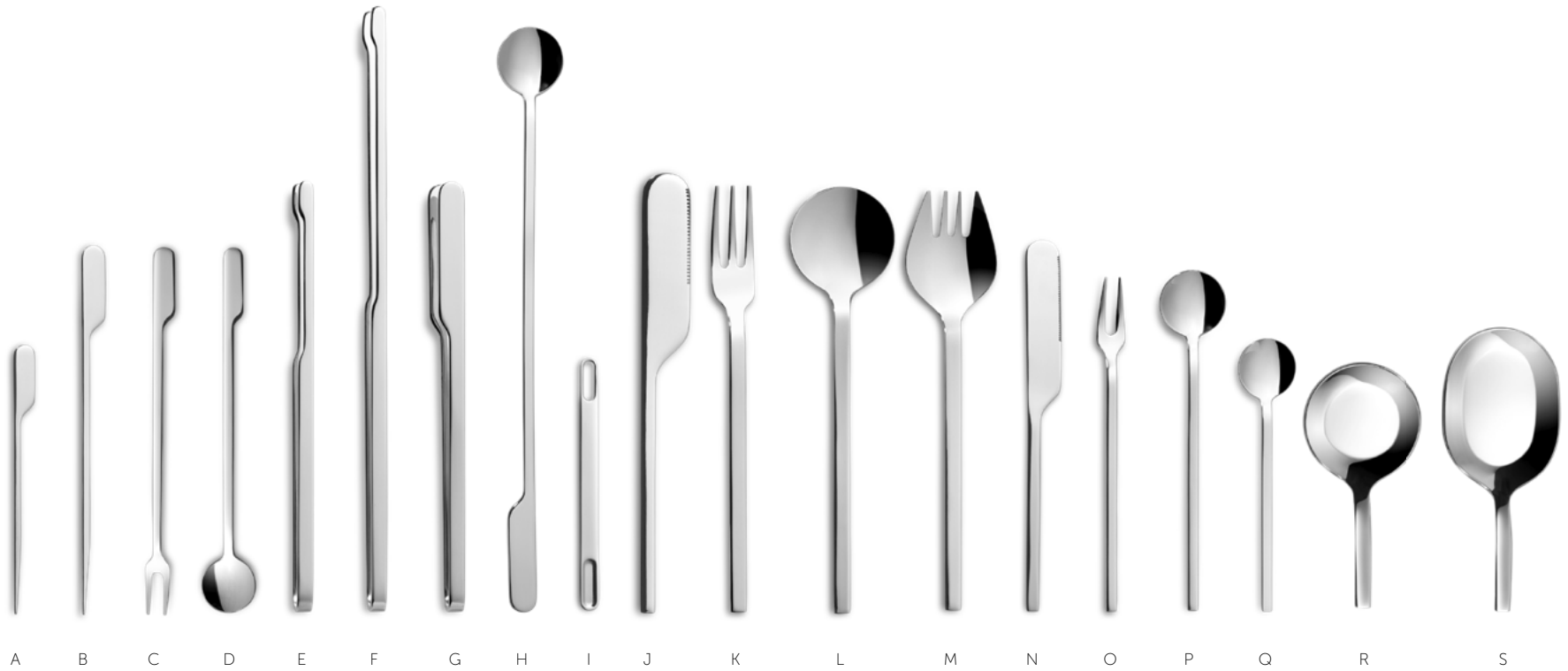

## LAB MIRROR



reddot design award  
winner 2020

2019 WINNER  
EUROPEAN  
PRODUCT  
DESIGN  
AWARD

			◆ cm	✕ cm	
A	C6980	Pincho / Cocktail stick	10	0.2	60 uds pcs
B	C6981	Pincho largo / Large cocktail stick	13.5	0.2	60 uds pcs
C	C6982	Tenedor aperitivo / Appetizer fork	13.5	0.2	60 uds pcs
D	C6983	Cuchara aperitivo / Appetizer spoon	13.5	0.2	60 uds pcs
E	C6996	Pinza corta / Short clamp	16	0.2	6 uds pcs
F	C6995	Pinza larga / Long clamp	22.2	0.2	6 uds pcs
G	C6997	Pinza espátula / Spatula clamp	16	0.2	6 uds pcs
H	C6988	Cuchara cóctel larga / Large cocktail spoon	21.5	0.2	60 uds pcs
I	C6989	Cuchara café espátula / Spatula coffee spoon	10.8	0.2	60 uds pcs
J	C7890	Cuchillo mesa monobloc / Monoblock table knife	16	0.2	60 uds pcs
K	C6977	Tenedor mesa / Table fork	15.4	0.2	60 uds pcs
L	C6978	Cuchara mesa / Table spoon	15.3	0.2	60 uds pcs
M	C6979	Tenedor arroz / Rice fork	14.8	0.2	60 uds pcs
N	C7891	Cuchillo lunch monobloc / Monobloc cake knife	18.3	0.2	60 uds pcs
O	C6986	Tenedor lunch / Cake fork	12.5	0.2	60 uds pcs
P	C6985	Cuchara lunch / Cake spoon	12.5	0.2	60 uds pcs
Q	C6984	Cuchara moka / Moka spoon	10.1	0.15	60 uds pcs
R	C6989	Cuchara degustación / Tasting spoon	8.6	0.2	6 uds pcs
S	C6999	Cuchara degustación oval / Oval tasting spoon	10.1	0.2	6 uds pcs

## LAB VINTAGE GOLD

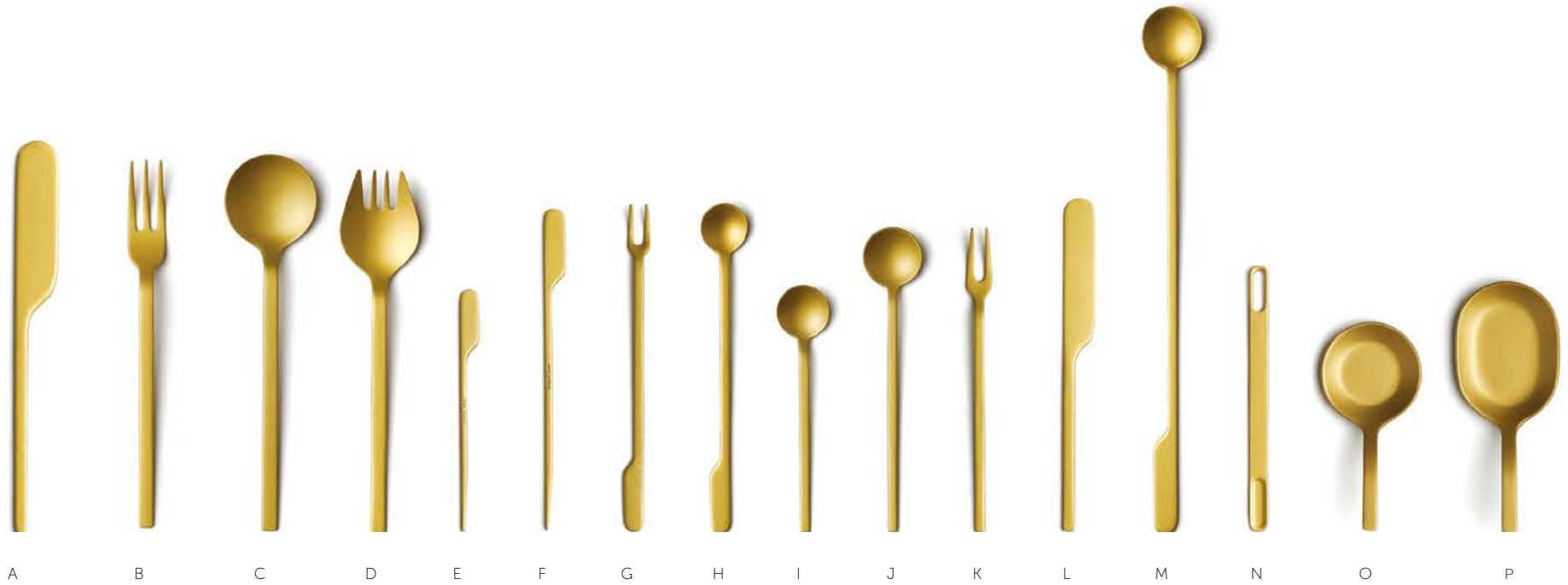

## LAB VINTAGE COOPER





## LAB ICE BLACK



## LAB COLORS



	GOLD	COPPER	BLACK		◆ cm	✕ cm	
A	C1539	C1555	C8640	Cuchillo mesa monobloc / Monobloc table knife	16	0.2	60 uds pcs
B	C1541	C1557	C7665	Tenedor mesa / Table fork	15.4	0.2	60 uds pcs
C	C1540	C1556	C8641	Cuchara mesa / Table spoon	15.3	0.2	60 uds pcs
D	C1542	C1558	C8642	Tenedor arroz / Rice fork	14.8	0.2	60 uds pcs
E	C1543	C1559	C8643	Pincho / Cocktail stick	10	0.2	6 uds pcs
F	C1544	C1560	C8644	Pincho largo / Large cocktail stick	13.5	0.2	6 uds pcs
G	C1545	C1561	C8645	Tenedor aperitivo / Appetizer fork	13.5	0.2	6 uds pcs
H	C1546	C1562	C8646	Cuchara aperitivo / Appetizer spoon	13.5	0.2	60 uds pcs
I	C1547	C1563	C8647	Cuchara moka / Moka spoon	10.1	0.15	60 uds pcs
J	C1549	C1565	C8649	Cuchara lunch / Cake spoon	12.5	0.2	60 uds pcs
K	C1550	C1566	C8650	Tenedor lunch / Cake fork	12.5	0.2	60 uds pcs
L	C1548	C1564	C8648	Cuchillo lunch monobloc / Monoblock cake knife	13.5	0.2	60 uds pcs
M	C1551	C1567	C8651	Cuchara coctel larga / Large cocktail spoon	21.5	0.2	60 uds pcs
N	C1552	C1568	C8652	Cuchara café espátula / Spatula coffee spoon	10.8	0.2	60 uds pcs
O	C1553	C1569	C8653	Cuchara degustación / Tasting spoon	8.6	0.2	60 uds pcs
P	C1554	C1570	C8654	Cuchara degustación oval / Oval tasting spoon	10.1	0.2	60 uds pcs

Portions have decreased and the refinement of some dishes make it essential to find the appropriate cutlery to taste them.

Tasting menus have relegated the main course to a non-existent plane, where liquid appetizers, suspended solids, aerial and ethereal elements in each composition, broths or infusions accompany and surround all kinds of food, ingredients from the 5 continents are present in the current cuisine, fusion of flavors and cultures, in this type of restaurants the portions are small and austere with the intention of concentrating in small mouthfuls explosions of flavor.

Dishes with an infinite number of shapes and natural supports, have been able to find and adapt to these changes, but not the cutlery.

Their size is often their main problem, spoons designed to sink into a broth, knives and forks grotesquely sized to face such delicacies.

LAB IS THE SOLUTION IN SIZE AND SHAPE



## EL PORQUÉ DE LAB THE REASON FOR LAB

Las raciones han disminuido y el refinamiento de algunos platos hacen indispensables buscar el cubierto apropiado para degustarlo.

Los menús degustación han relevado al plato principal a un plano inexistente, donde aperitivos líquidos, sólidos suspendidos, elementos aéreos y etéreos en cada composición, caldos o infusiones acompañan y rodean todo tipo de alimentos, ingredientes de los 5 continentes son presentes en la cocina actual, fusión de sabores y culturas.

En este tipo de restaurantes las porciones son pequeñas y austeras con la intención de concentrar en pequeños bocados explosiones de sabor. Platos con infinidad de formas y soportes naturales, han sabido buscar y adaptarse a estos cambios, pero no así los cubiertos.

Su tamaño es muchas veces su principal problema, cucharas pensadas para hundirse dentro de un caldo, cuchillos y tenedores grotescamente dimensionados para enfrentarse a tales delicadezas.

LAB ES LA SOLUCION EN DIMENSIONES Y FORMAS

## LAB ACCESORIOS LAB ACCESSORIES

Esta colección está diseñada en diferentes materiales, formas y colores. Un conjunto de líneas minimalistas que permite servir aperitivos, tapas, arroces y un sinfín de emplatados.

También cuenta con platos de acero inoxidable, porcelana mate y bases de madera, creando un conjunto muy versátil.

Introducing our latest collection, designed with diverse materials, shapes, and colors. With its minimalist lines, this set is perfect for serving appetizers, tapas, rice dishes, and so much more. Our collection also includes sleek stainless steel plates, matte porcelain plates, and wooden bases that add to its versatility, making it a must-have for any occasion.

Base madera  
Wood tray

4 uds  
4 pcs

C8370 Simple 9.25 x 27.8 cm

C8371 Doble 18.5 x 27.8 cm



C8001  
Disco Pinchos  
Round Stick Holder

6 uds  
6 pcs

Ø 9 cm  
Altura / Height: 2,75 cm





## LAB TABLE TOP Inox 18/10



4 uds  
pcs

**C8000**

Plato 1/4 ración redondo  
1/4 ration circle plate

9.25 x 9.25 cm



4 uds  
pcs

**C8005**

Plato ración oval  
1 ration oval plate

9.25 x 27.8 cm



4 uds  
pcs

**C8002**

Plato ración redondo  
1 ration circle plate

18.5 x 18.5 cm



4 uds  
pcs

**C8004**

Plato 1/4 ración redondo doble  
1/4 ration circle double plate

9.25 x 18.5 cm



4 uds  
pcs

**C8003**

Plato 1/2 ración oval  
1/2 ration oval plate

9.25 x 18.5 cm



4 uds  
pcs

**C8006**

Plato 1/2 ración oval + pinchos  
1/2 ration oval plate + stick holder

9.25 x 27.8 cm

LAB TABLE TOP  
Porcelana / Porcelain



4 uds  
pcs

C9984  
Plato gest  
Gest plate

11 x 10.5 cm Alt / Height: 3 cm

Base porcelana pequeña  
Simple porcelain tray

4 uds  
pcs

C8598 Blanco / White

C8600 Verde / Green

C8602 Azul / Blue

C8596 Negro / Black

9.25 x 27.8 cm

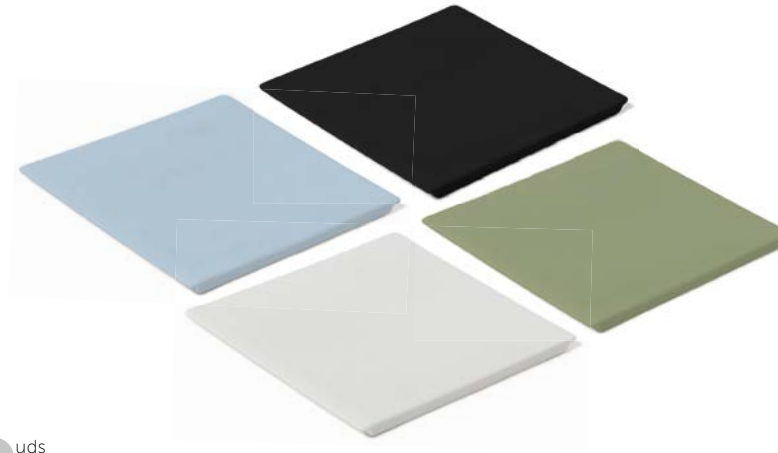

Base porcelana grande  
Double porcelain tray

4 uds  
pcs

C8599 Blanco / White

C8601 Verde / Green

C8603 Azul / Blue

C8597 Negro / Black

18.5 x 18.5 cm

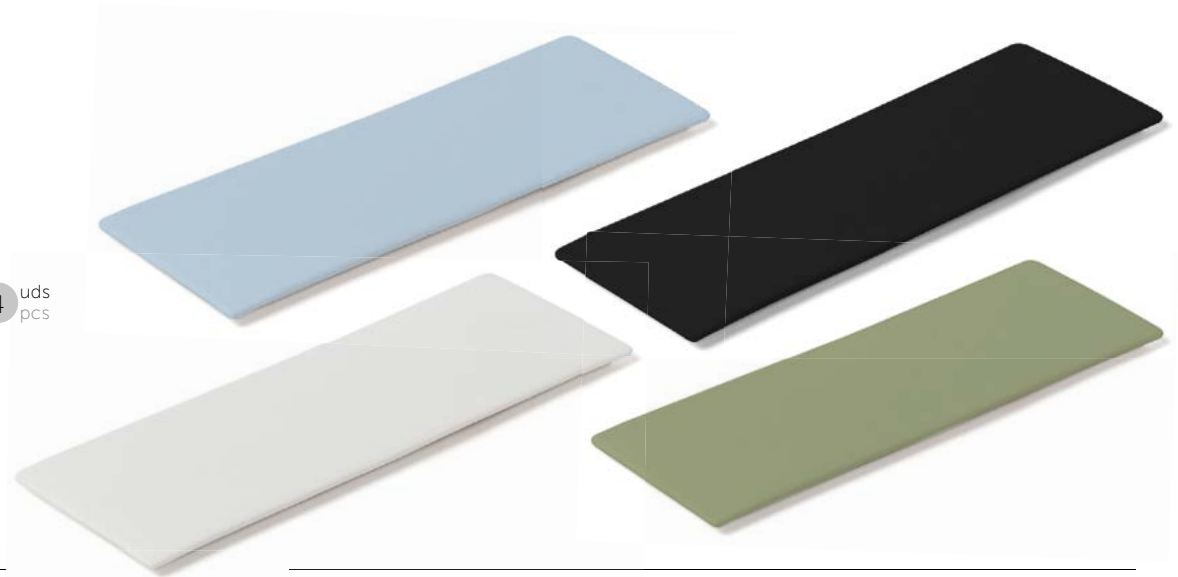



## VERSAILLES

Elegante cubertería con un diseño clásico que aporta un toque de sofisticación a mesa.

Las piezas son robustas y están decoradas con delicadeza desde el inicio hasta el final del mango, irradiando elegancia y encanto. Hecha de acero inoxidable 18/10, esta cubertería puede soportar un uso intensivo.

Disponible en cuatro colores diferentes.

Una exquisita cubertería de belleza atemporal.

Introducing our elegant cutlery set with a classic design that adds a touch of sophistication to your table. The pieces are robust and delicately decorated from the beginning to the end of the handle, radiating elegance and charm.

Made from 18/10 stainless steel, this cutlery can withstand intensive use. With four different colors to choose from, you can customize your table setting to suit any occasion and style.

An exquisite cutlery set with timeless beauty.



## VERSAILLES SATIN



A



B



C



D



E



F



G



H



I



## VERSAILLES SATIN GOLD



A



B



C



D



E



F



G



H



I

## VERSAILLES SATIN BLACK



# VERSAILLES SATIN COPPER



I



H



G



F



E



D



C



B



A

## VERSAILLES



SATIN GOLD BLACK COPPER

						◆ cm	✕ cm	60 uds pcs
A	C7765	C5736	C5745	C5754	Cuchillo mesa / Table knife	24.5	0.35	
B	C7766	C5737	C5746	C5755	Cuchara mesa / Table spoon	21	0.35	
C	C7767	C5738	C5747	C5756	Tenedor mesa / Table fork	21	0.35	
D	C7770	C5739	C5748	C5757	Cuchillo postre / Dessert knife	22	0.35	
E	C7771	C5740	C5749	C5758	Cuchara postre / Dessert spoon	19	0.3	
F	C7772	C5741	C5750	C5759	Tenedor postre / Dessert fork	19	0.3	
G	C7773	C5742	C5751	C5760	Tenedor lunch / Cake fork	14	0.25	
H	C7774	C5743	C5752	C5761	Cuchara café / Tea spoon	14	0.25	
I	C7775	C5744	C5753	C5762	Cuchara moka / Moka spoon	11.5	0.18	



## ATLÁNTIDA

Colección de cubiertos con líneas fluidas, extremadamente sofisticada y contemporánea. Está realizada en acero inoxidable texturizado, proporcionando a cada pieza un tacto y peso muy agradable.

Su minimalismo permite combinarla fácilmente con platos y vajillas de diferentes estilos y formas, convirtiéndola en una adición versátil a cualquier mesa.

Collection of cutlery with fluid lines, extremely sophisticated and contemporary. It is made of textured stainless steel, providing each piece with a very pleasant touch and weight.

Its minimalism allows it to be easily combined with plates and dishes of different styles and shapes, making it a versatile addition to any table.



4  
uds  
pcs

C10431  
Reposa cubiertos  
Cutlery holder

19 x 8 cm

Base de acero y madera.  
Steel and wood base.

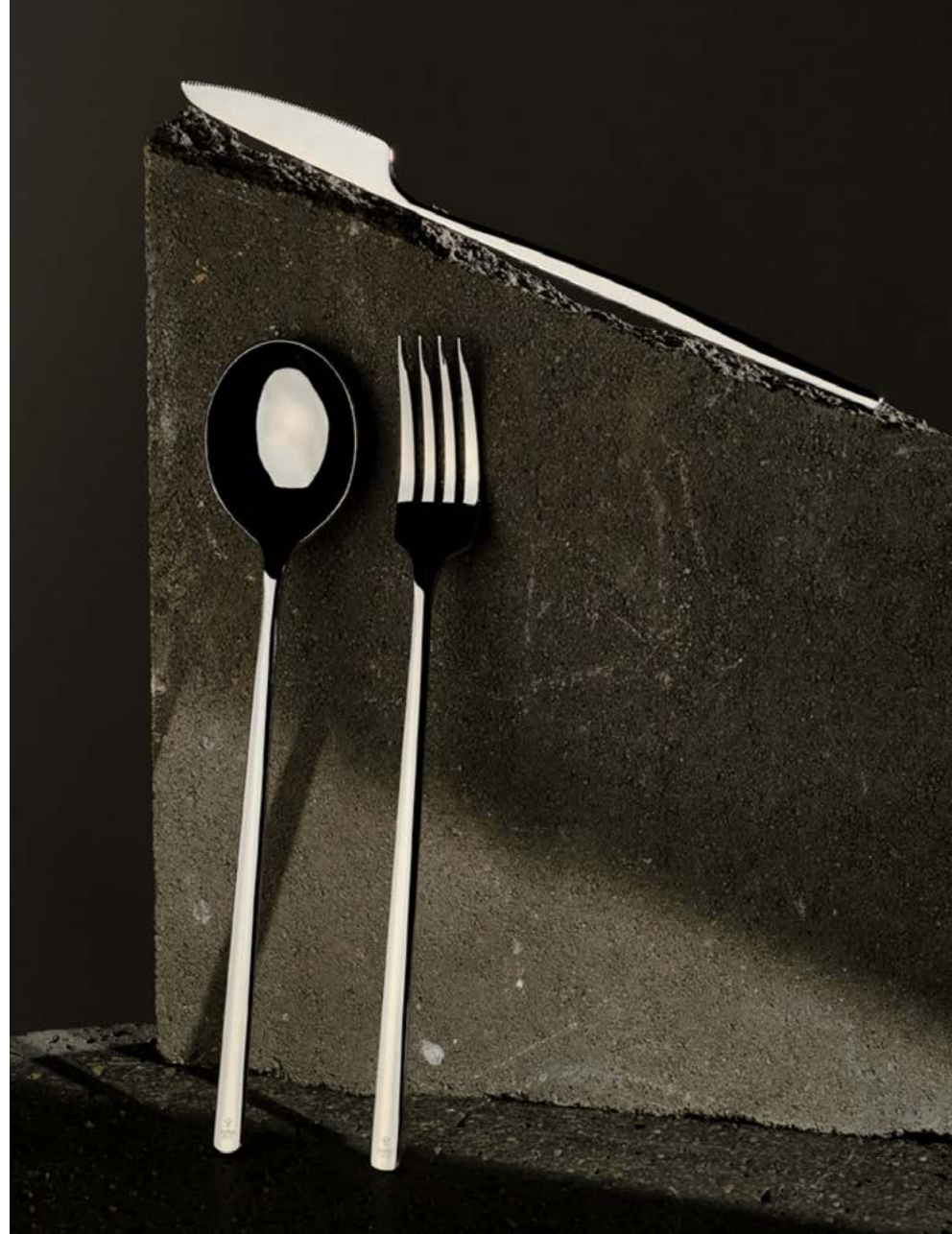

## ATLÁNTIDA MIRROR



			◆ cm	✕ cm	60 uds pcs
A	C8586	Cuchillo mesa / Table knife	22.6	0.6	
B	C8587	Cuchara mesa / Table spoon	21.5	0.6	
C	C8588	Tenedor mesa / Table fork	21.8	0.6	
D	C8656	Cuchara salsa / Sauce spoon	21.6	0.6	
E	C8589	Cuchillo lunch / Cake knife	16.9	0.6	
F	C8591	Cuchara lunch / Cake spoon	16.3	0.5	
G	C8590	Tenedor lunch / Cake fork	16	0.5	
H	C8592	Cuchara café / Tea spoon	10.9	0.35	
I	C10431	Reposa cubiertos / Cutlery holder	19	0.15	

## ATLÁNTIDA BLACK



			◆ cm	✕ cm	60 uds pcs
A	C8579	Cuchillo mesa / Table knife	22.6	0.6	
B	C8580	Cuchara mesa / Table spoon	21.5	0.6	
C	C8581	Tenedor mesa / Table fork	21.8	0.6	
D	C8655	Cuchara salsa / Sauce spoon	21.6	0.6	
E	C8582	Cuchillo lunch / Cake knife	16.9	0.6	
F	C8584	Cuchara lunch / Cake spoon	16.3	0.5	
G	C8583	Tenedor lunch / Cake fork	16	0.5	
H	C8585	Cuchara café / Tea spoon	10.9	0.35	



Mango hueco para una manipulación más ligera



Hollow handle for lighter handling



Set palillos inox  
Chopsticks set 18/10 12 sets

- C7421 Inox
- C7422 PVD Black
- C7423 PVD Copper
- C7424 PVD Gold

23 x 1.1 cm

Mini cubiertos de Inox 18%, libre de níquel. Su tamaño es perfecto para degustar diferentes sabores y platos en cualquier momento y lugar. Diseñados para durar y resistir el uso diario.

Mini cutlery made of 18% stainless steel, nickel-free. For these size are perfect for tasting different flavors and dishes anytime, anywhere. Designed to last and withstand daily use.

Finger food 24 uds  
pcs

- C8784 Cuchillo lunch / Cake knife 140 x 0.6 cm
- C8786 Cuchara café / Tea spoon 140 x 0.6 cm
- C8785 Tenedor lunch / Cake fork 140 x 0.6 cm
- C8787 Pincho tapas / Cocktail stick 140 x 0.6 cm

## SILEX

Inspirada en las herramientas más antiguas de la edad de piedra, la cubertería Silex emula la dureza y la capacidad de corte de las armas más antiguas.

Un cuchillo y un tenedor chuletero que impresionan por su tamaño de 18.5 cm y tacto satinado. Realizados en INOX 18/10.

Inspired by the oldest tools of the Stone Age, Silex cutlery emulates the hardness and cutting ability of the earliest weapons.

A steak knife and fork that impress with their size of 18.5 cm and satin touch. Made of 18/10 stainless steel.



C6318 Cuchillo chuletero / Steak knife 20 uds  
pcs

C6319 Tenedor chuletero / Steak fork 20 uds  
pcs

C6322 Cuchillo + tenedor / Knife + fork 8 uds  
pcs

18.5 cm





## LES ESSENCES

Nuevo concepto para el servicio de catering con piezas de diseño totalmente complementarias entre ellas para crear un conjunto práctico y versátil sin renunciar a la elegancia. El conjunto está compuesto por bandejas de aluminio, ligeras, resistentes y perfectas para un servicio cómodo. Aptas para hornear y en algunos casos compatibles con el sistema GN 1/1. También cuenta con soportes para diferentes emplatados como piruletas, conos, tacos o brochetas. Así como cucharas de degustación en acero inoxidable, pensadas para la degustación de aperitivos rápidos. Finalmente, nos ofrece una vajilla de porcelana de alta calidad totalmente modulable a juego con las bandejas.

New concept for catering service with design pieces that complement each other to create a practical and versatile set without sacrificing elegance. The set is composed of aluminum trays, light, resistant and perfect for a comfortable service. Suitable for baking and in some cases compatible with the GN 1/1 system. It also has supports for different types of plating such as lollipops, cones, tacos or skewers. As well as stainless steel tasting spoons, designed for tasting quick appetizers. Finally, it offers a high quality porcelain tableware fully modular to match the trays.



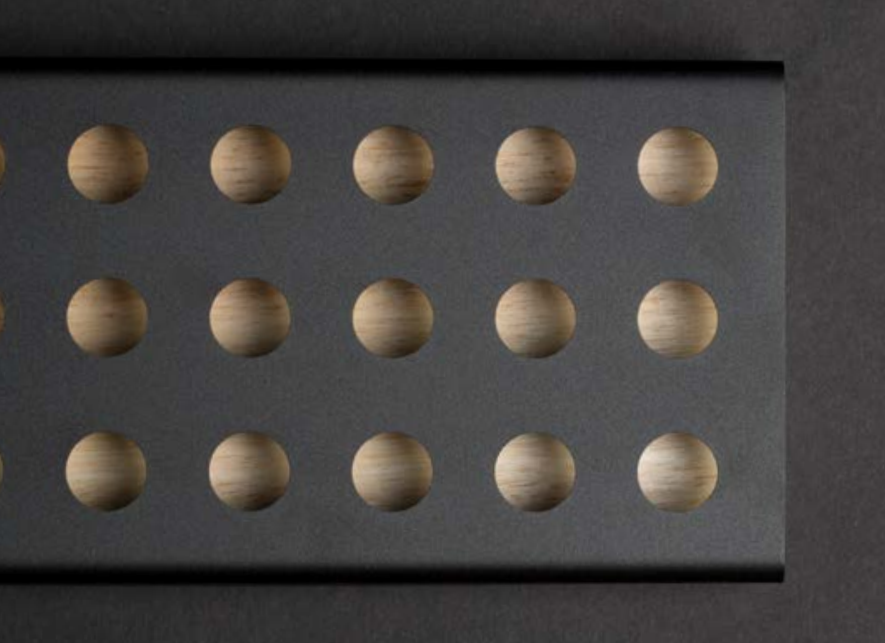

Asas y paredes oblicuas para facilitar el apilado

Handles and oblique walls for easy stacking

Pie de 5mm de grossor que evita que la bandeja apoye directamente en la mesa, dando un aspecto más ligero.

5mm thick foot that prevents the tray from resting directly on the table, giving a lighter appearance.



### Bandeja rectangular pequeña

Small tray

4 uds  
pcs

C7579 ● Soft Argento

C7588 ● Pure carbon

15 x 27 cm  
Alt/Height: 6.9 cm



Bandejas con un diseño apilable y muy ligero, soportan la congelación y temperaturas de hasta 80°C. También son aptas para lavavajillas.

Trays with a stackable and very light design, supports freezing and temperatures up to 80°C. They are also dishwasher safe.

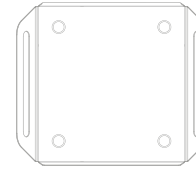

### Bandeja cuadrada

Square tray

4 uds  
pcs

C7581 ● Soft Argento

C7590 ● Pure carbon

28.5 x 27 cm  
Alt/Height: 6.9 cm





Bandeja rectangular estrecha

Tight tray

4 uds  
pcs

C7580 ● Soft Argento

C7589 ● Pure carbon

15 x 52.5 cm

Alt/Height: 9.6 cm



Bandeja rectangular grande

Big tray

4 uds  
pcs

C7582 ● Soft Argento

C7591 ● Pure carbon

28 x 52.5 cm

Alt/Height: 9.6 cm







Bandeja room service  
Room Service Tray

4 uds  
pcs

C7930 ● Soft Argentó

38.5 x 52 cm  
Alt/Height: 6.9 cm



La bandeja room service dispone de unas medidas especiales. Es la bandeja más grande de la colección y junto con la vajilla de porcelana Les Essences, es perfecta tanto para servir una comida completa en habitación, como para un servicio de sala.

The room service tray has special measurements. It is the largest tray in the collection and together with the porcelain tableware Les Essences, it is perfect for serving a complete meal in the room, as well as for a restaurant service.



Cubrebandeja silicona  
Silicon Tray Cover

1 ud  
pc

C7438	14.5 x 26.5 cm	Compatible: C7579 / C7588
C7439	14.5 x 52 cm	Compatible: C7580 / C7589
C7440	28 x 26.5 cm	Compatible: C7581 / C7590
C7441	28 x 52 cm	Compatible: C7582 / C7591



Cubrebandeja corcho rectangular  
Cork Tray Cover

1 ud  
pc

C7845	14.5 x 26.5 cm	Compatible: C7579 / C7588
C7846	14.5 x 52 cm	Compatible: C7580 / C7589
C7847	28 x 26.5 cm	Compatible: C7581 / C7590
C7848	28 x 52 cm	Compatible: C7582 / C7591
C7931	38 x 51.5 cm	Compatible: C7930



## Vajilla Tableware

Vajilla de porcelana de alta calidad fabricada en 2 tiempos de cocción a más de 1200°C. Impermeable a manchas de los alimentos, resistente y suave al tacto tienen un diseño modular que encaja perfectamente sobre las bandejas de aluminio de la colección.

This high-quality porcelain dinnerware is crafted through a two-step firing process at temperatures exceeding 1200°C. It's food colors resistant, hard work resistant but smooth to the touch, and features a modular design that fits seamlessly onto the collection's aluminum trays.



70 ml



A

400 ml



B



C



D



E



G



F

### Vajilla de porcelana Porcelain Tableware

4 uds  
pcs

A	C7679	Vaso / Cup	6 x 6 cm Alt /Height: 6 cm
B	C7670	Bol / Bowl	12 x 12 cm Alt /Height: 12 cm
C	C7681	Plato postre / Dessert plate	12 x 12 cm Alt /Height: 1.8 cm
D	C7672	Plato llano / Dinner plate	24 x 24 cm Alt /Height: 1.3 cm
E	C7671	Bandeja simple / Simple tray	12 x 24 cm Alt /Height: 1.5 cm
F	C7680	Barquillo / Wafer	6 x 24 cm Alt /Height: 1.8 cm
G	C7673	Bandeja doble / Double tray	12 x 48 cm Alt /Height: 1.3 cm





## Bandeja sistema GN 1/1 GN 1/1 Tray system



Apilable para un mejor almacenaje  
Stackable for easy storage

Con las medidas estándar del sistema de catering Gastronorm, esta bandeja puede ser utilizada tanto para almacenamiento seco o refrigerado, cocinado y presentación de alimentos.

Son la solución ideal para usar en vitrinas, buffets o mesas frías.

Igual que las otras bandejas de la colección, están fabricadas en aluminio mate.

With standard dimensions of Gastronorm catering system, this tray can be used for both dry and refrigerated storage, cooking and food presentation.

Are the ideal solution for use in showcases, buffets or cold tables.

Like the other trays in the collection, they are made of matt aluminum.

Fabricado en aluminio ligero que facilita el transporte y soporta hornados de hasta 250°C

Lightweight aluminum, easy to transport and withstands baking temperatures up to 250°C

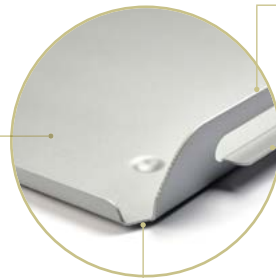

Grueso de 0.15 cm para una mayor resistencia  
0.15 cm thick for extra strenght

Ala externa que permite almacenar las bandejas en los trolley  
External wing for storing trays on trolleys

Su ancho de 32.5 cm encaja tanto en las guías de los hornos industriales como en las cajas de transporte GN  
Its 32.5 cm width fits both industrial oven rails and GN transport boxes



Bandeja GN 1/1  
Tray GN 1/1

4 uds  
4 pcs

C9991 ● Soft argento

C9992 ● Pure carbon

38.5 x 52 cm  
Alt/Height: 6.9 cm



Adaptable a cajas de transporte con guías  
Adaptable to transport boxes with guides

1 ud  
1 pc

C10785  
Cubrebandeja silicona GN 1/1  
Silicon tray cover GN 1/1  
32.5 x 53 cm



No resbala, protege y resiste alta temperatura  
Non-slip, protective and high temperature resistant



Adaptable a hornos industriales y carros GN  
Adaptable to industrial ovens and GN trolleys



## Soportes Supports

Soportes de aluminio mate para servicio de aperitivos y snacks.

Ligeros, modulares y combinables con las bandejas de la misma colección, ayudaran a agilizar cualquier pase de catering.

These matte aluminum supports are great for serving appetizers and snacks. They are lightweight, modular, and can be combined with trays from the same collection, making it easy to pass food around quickly during any catering event.



Soporte conos  
Cones support

4 uds  
pcs

C7586 ● Soft argento

C7595 ● Pure carbon

12 x 24 cm Alt / Height: 4 cm



Soporte piruletas  
Lollipops support

4 uds  
pcs

C7585 ● Soft argento

C7594 ● Pure carbon

12 x 24 cm Alt / Height: 4 cm



Bandeja madera roble  
Oak wood tray

4 uds  
pcs

C7587

12 x 24 cm Alt / Height: 2 cm



**C7583**  
Soporte tacos  
Tacos support  
12 x 24 cm  
Alt / Height: 4 cm

4 uds  
pcs



**C7584**  
Soporte brocheta  
Skewers support  
6 x 24 cm  
Alt / Height: 4 cm

4 uds  
pcs



**C7592**  
Soporte tacos  
Tacos support  
12 x 24 cm  
Alt / Height: 4 cm

4 uds  
pcs



**C7593**  
Soporte brocheta  
Skewers support  
6 x 24 cm  
Alt / Height: 4 cm

4 uds  
pcs



# Cucharas degustación

## Tasting spoons



Cuchara degustación plana  
Flat tasting spoon

12 uds  
pcs

C7576  Vintage

C7577  Vintage PVD intense gold

C7578  Vintage PVD pure carbon

8.5 cm

Especialmente pensada para la degustación de aperitivos en un servicio de catering.

Specially designed for tasting appetizers in a catering service.



Al igual que los soportes, la cucharas de degustación están pensadas para la degustación de aperitivos y snacks rápidos durante un servicio de catering. Dispone de diferentes modelos que permiten variedad de emplatados. Fabricadas en acero inoxidable 18/10 con un recubrimiento de PVD.

El PVD es una tecnología de recubrimiento avanzada y versátil que mejora significativamente la durabilidad y la estética de cualquier objeto.

Just like supports, tasting spoons are designed for the tasting of appetizers and quick snacks during a catering service. They come in different models that allow for a variety of plating options. Made of 18/10 stainless steel with a PVD coating.

PVD is an advanced and versatile coating technology that can significantly improve the durability and aesthetics of any object.



## Cuchara degustación mango Handle tasting spoon

12 uds  
pcs

C7564	●	Perforated vintage
C7565	●	Vintage
C7566	●	Vintage PVD intense gold
C7567	●	Vintage PVD pure carbon

12 cm



## Cuchara degustación espátula Spatula tasting spoon

12 uds  
pcs

C7572	●	Perforated vintage
C7573	●	Vintage
C7574	●	Vintage PVD intense gold
C7575	●	Vintage PVD pure carbon

7.5 cm



## Cuchara degustación pala Spade tasting spoon

12 uds  
pcs

C7568	●	Perforated vintage
C7569	●	Vintage
C7570	●	Vintage PVD intense gold
C7571	●	Vintage PVD pure carbon

7.5 cm





## Bandeja iluminación Led Led light Tray

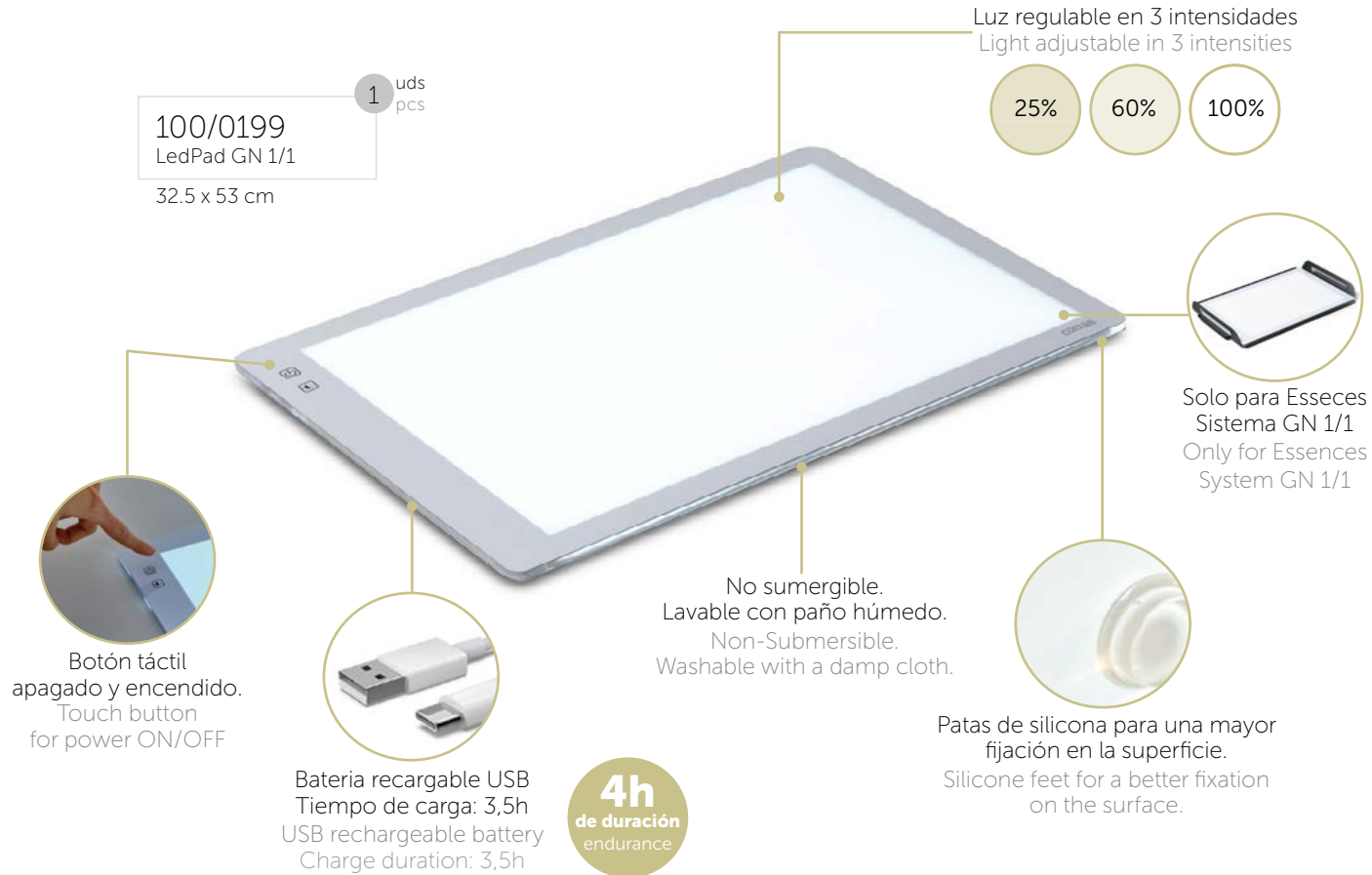

1 uds  
pcs

100/0199  
LedPad GN 1/1  
32.5 x 53 cm

Luz regulable en 3 intensidades  
Light adjustable in 3 intensities

25%

60%

100%

Solo para Esseces  
Sistema GN 1/1  
Only for Essences  
System GN 1/1

Botón táctil  
apagado y encendido.  
Touch button  
for power ON/OFF

Bateria recargable USB  
Tiempo de carga: 3,5h  
USB rechargeable battery  
Charge duration: 3,5h

4h  
de duración  
endurance

No sumergible.  
Lavable con paño húmedo.  
Non-Submersible.  
Washable with a damp cloth.

Patas de silicona para una mayor  
fijación en la superficie.  
Silicone feet for a better fixation  
on the surface.

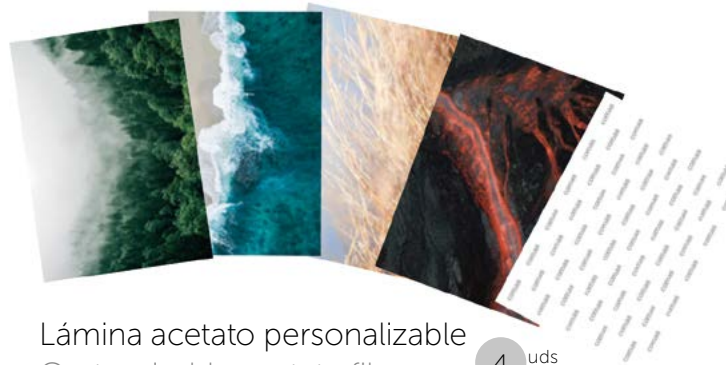

Personalice su bandeja según los platos o aperitivos. También puede pedir una lámina con su logo.  
 Customize your tray according to your dishes or appetizers. You can also order a plate with your logo.

Lámina acetato personalizable  
 Customisable acetate film

4 uds  
 pcs

- C10786 Agua / Water
  - C10799 Fuego / Fire
  - C10800 Tierra / Earth
  - C10801 Personalizado / Customizable
- 29.7 x 42 cm



4 uds  
 pcs

C10808  
 Lámina metacrilato protector  
 Methacrylate protective sheet

32.5 x 53 cm

Lámina de metacrilato protectora  
 Apto para contacto alimentario  
 Protective methacrylate sheet  
 Suitable for food contact

Lámina personalizable  
 para cualquier emplatado  
 Customisable film for any dish

Base Led GN 1/1  
 Led tray GN 1/1

Bandeja GN 1/1 Les Essences  
 Tray GN 1/1 Les Essences

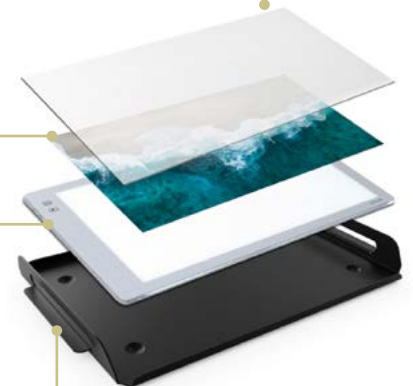



# Catering

Presentación ideal  
Ideal presentation





## Colección BIANCO BIANCO Collection

Originales piezas de diseño con elegante acabado blanco mate, pensadas para presentar piezas de 2 en 2 o de 4 en 4. Ofrecen una multitud de posibilidades y combinaciones de presentación: tacos, mini bocaditos, bollería, etc. Termo-formadas en resina acrílica: material ligero a baja densidad, altamente resistente, preparado para resistir ambientes salinos, exposición al vapor, ambientes helados o congelados. Prácticamente indestructibles, no se rayan ni se manchan con la comida, pueden pulirse con un estropajo verde y como nuevas. Además son resistentes hasta 80°C y 100% reciclables.

Unique design made to present 2 pieces or 2 pairs of food at the time, made with an elegant white matte finish. This support is extremely versatile: serve tacos, mini sandwiches, pastries. Thermoformed with acrylic resin: a low-density and light material, super-resistant and salt-proof. It resists to vapor, freezer and temperatures until 80°C. Virtually indestructible, they don't get stained by food. Easy to clean with a scouring pad. 100% Recyclable.

500/0003  
WAVE CRUNCHY 1

7 x 6 cm  
Altura / Height: 4 cm



500/0004  
WAVE CRUNCHY 2

13 x 6 cm  
Altura / Height: 4 cm

500/0005  
WAVE TACO 2/3

21 x 6 cm  
Altura / Height: 4.5 cm



500/0002  
WAVE BAGUETTE 2

15.5 x 10 cm  
Altura / Height: 5 cm



500/0006  
WAVE TACO 4/5

35.5 x 6 cm  
Altura / Height: 4.5 cm

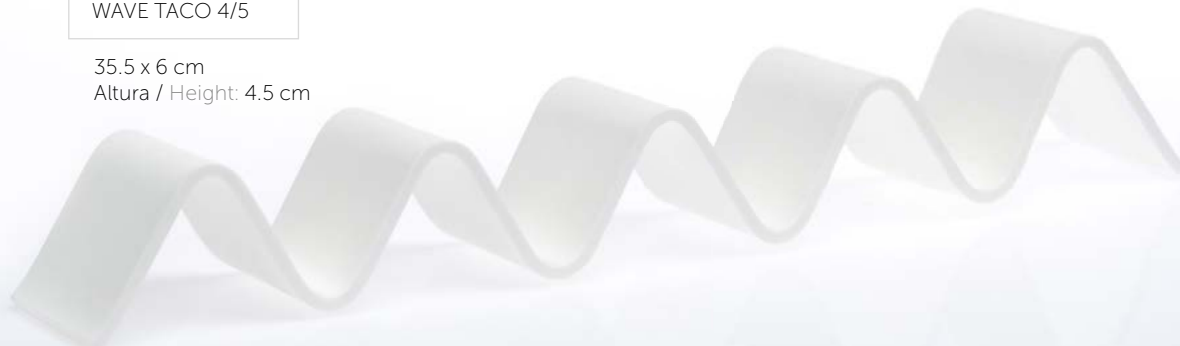

500/0001  
WAVE BAGUETTE 4

29.5 x 10 cm  
Altura / Height: 5 cm



500/0201  
SPRING CONE

9 x 6 cm  
Altura / Height: 4.5 cm



500/0202  
SPRING PIPETTE

9 x 6 cm  
Altura / Height: 5 cm



500/0203  
SPRING CRUNCHY

9 x 6 cm  
Altura / Height: 4.5 cm



500/0204  
SPRING SKEWER

9 x 6 cm  
Altura / Height: 4.5 cm



100/0173  
Tapón Negro Silicona  
Silicone Black Tube Cap

Ø 2,5 cm  
Altura / Height: 3.3 cm

10 uds  
pcs

100/0171  
Tubo de ensayo maxi  
Maxi test tube

100/0172  
Tubo de ensayo maxi  
Maxi test tube

20 uds  
pcs

40 uds  
pcs

90 ml

90 ml



500/0105  
BRIDGE DUO

500/0103  
BRIDGE LABO

8 x 7 cm  
Altura / Height: 15.5 cm



500/0101  
BRIDGE DOUBLE HOLE

Ø 4 cm



500/0102  
BRIDGE HOLE

Ø 4 cm



500/0106  
BRIDGE DOUBLE HOLLOW



500/0109  
BRIDGE FLAT

8 x 7 cm  
Altura / Height: 8 cm

500/0107  
BRIDGE HOLLOW

500/0108  
BRIDGE DOUBLE FLAT

15.5 x 7 cm  
Altura / Height: 8 cm

500/0104  
BRIDGE COMBI

CATERING - 323





100/1002

Lata aluminio oval con tapa  
Oval aluminium cans with lid

11 x 7 x 3 cm

100 uds  
pcs

120 ml



100/0057

Lata aluminio rectangular con tapa  
Rectangle aluminium cans with lid

11 x 5.5 x 2 cm

100 uds  
pcs

60 ml

LATAS DEGUSTACIÓN  
TASTING CANS

Latas de conserva vacías con tapa abre fácil separada, ideal para presentar raciones de alimentos frescos como simul de producto en conserva.

Estos envases son para uso exclusivo como plato degustación.

Empty preserve cans with lid. Ideal to present portions of fresh food as if it were canned. These cans can be used only for food presentation.

100/1041

Lata aluminio redonda con tapa  
Round aluminium cans with lid

Ø 7.15 cm Altura / Height: 2.8 cm

100 uds  
pcs

88 ml



100/1043

Plato Tapa aluminio  
Plate Tapa aluminium

Ø 8 cm

100 uds  
pcs



Práctico sistema de cerrado con el cierralatas manual Ref. 100/0055  
Easy closing system with the manual can sealer Ref. 10070055



100/1042

Lata bowl aluminio con tapa  
Bowl aluminium can with lid

100 uds  
100 pcs

150 ml

Ø 11 cm Altura / Height: 3.5 cm



100/1006

Lata hojalata redonda con tapa XS  
Round tin can with lid

100 uds  
100 pcs

120 ml

Ø 11 cm Altura / Height: 2.2 cm



Práctico sistema de cerrado  
con el cierralatas manual  
gigante - Ref. 100/1000  
Easy closing system with the  
giant manual can sealer  
Ref. 100/1000



100/1005

Lata hojalata redonda con tapa XL  
Round tin can with lid

50 uds  
50 pcs

280 ml

Ø 14 cm  
Altura / Height: 3 cm



100/0133

Lata Aluminio Gigante Dorada  
Aluminium Giant Golden Can

42 uds  
42 pcs

750 ml

17 x 11 x 6 cm



Para latas redondas  
de Ø 8 cm (100/1041 - 100/0187)  
For round cans  
of Ø 8 cm (100/1041 - 100/0187)

**100/0055**  
Cierralatas redondas manual  
Manual round can sealer



MODELOS  
PATENTADOS  
PATENTED  
MODELS



**100/1000**  
Cierralatas manual gigante  
Giant manual can sealer



Para latas redondas  
de Ø 11 cm (100/1042, 100/1006)  
For round cans  
of Ø 11 cm (100/1042, 100/1006)



60 uds  
pcs

100/0186

Mini lata Olivas redonda con tapa  
Mini round tin can with lid

250 ml

Ø 7 cm

Altura / Height: 7 cm



42 uds  
pcs

100/0187

Lata Popeye hojalata con tapa  
Popeye tin can with lid

400 ml

Ø 7.9 cm

Altura / Height: 11 cm



Práctico sistema de cerrado

con el cierralatas manual

Ref. 100/0055

Easy closing system with

the manual can sealer

Ref. 100/0055





## Tubos de aluminio Aluminium tubes

Mini tubos de aluminio desechables con aplicador, ideal para rellenar con mieles aromatizadas, cremas, jugos espesos, mahonesas creativas y salsas. De fácil y rápido relleno permite servir monodosis en cualquier catering o aperitivo. Varios tamaños, colores y tapones.

Mini disposable aluminium tubes with applicator, perfect for filling with aromatized honeys, creams, thick juices, creative mayonaises and sauces.

Easy to fill, they offer possibility to serve single doses in any catering. Several sizes, colours, shapes, caps.



## TUBOS ALUMINIO ALUMINIUM TUBES

100 uds  
pcs

90/0001 Blanco · White

90/0014 Plata · Silver

90/0015 Cobre · Copper

90/0020 Negro · Black

90/0005 Blanco · White

90/0016 Plata · Silver

90/0017 Cobre · Copper

90/0021 Negro · Black

90/0002 Blanco · White

90/0018 Plata · Silver

90/0019 Cobre · Copper

7 ml

15 ml

30 ml



**Chapa**  
*tubos*



90/0011  
CHAPA TUBOS  
Pinza para cerrar tubos de aluminio  
Aluminium Tube Crimper Pliers



PERSONALIZABLES  
CUSTOMIZABLES



# EAT & DRINK

Versátiles e indispensables para el servicio de aperitivos y tapas creativas así como coctelería, pre-postres, decoración de platos, etc. Resistentes al ácido del vinagre o del limón, lo que las hace indispensables para el uso de salsas ácidas como vinagretas o escabeches.

Versatile and very resistant to the acids and all kind of liquids. Indispensable for serving appetizers & snacks, cocktails, desserts, vinaigrettes, sauces, juices.



APTO PARA CONTACTO CON ALIMENTOS  
FOOD GRADE MATERIAL

Pueden congelarse en nitrógeno líquido.  
Can be frozen with liquid nitrogen.

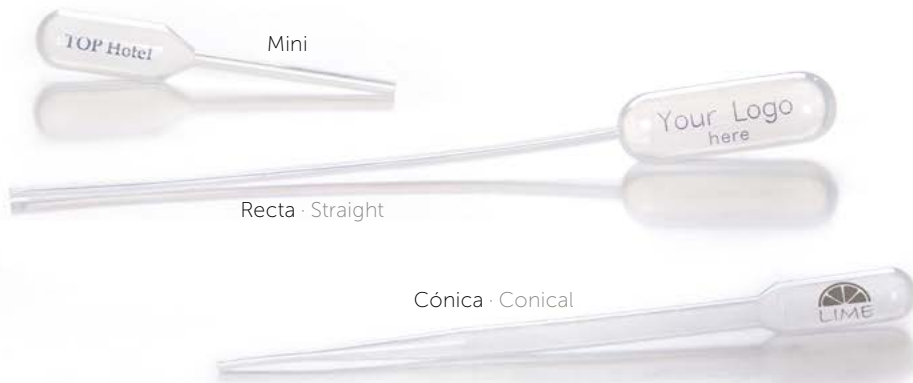

## PIPETAS POLIETILENO POLYETHYLENE PIPETTES

500 uds  
pcs

100/0013 Recta · Straight 4.5 ml / 15.5 cm

100/0014 Cónica · Conical 5 ml / 15.5 cm

100/0015 Mini 1.2 ml / 6.5 cm

100/2008 Estrella 1.2 ml / 6.5 cm

100/2009 Lollipop 1.2 ml / 6.5 cm

100/2010 Corazón 1.2 ml / 6.5 cm



## TUBOS DE ENSAYO

### Test tubes

Tubos de ensayo con reborde, ideal para beber pequeños cocktails o servir infusiones o sopas de acompañamiento. Fabricados en vidrio borosilicato, es extremadamente duro, con alta resistencia a los cambios bruscos de temperatura.

Test tubes with thread, made from borosilicate (an extremely hard glass), with a high resistance to temperature changes.

Ideal for small cocktails drinking or for serving creative drinks or accompaniment soups.

100/0054

Tapones de corcho para tubos de Ø 1.6 cm  
Cork for test tubes of Ø 1.6 cm

200  
uds  
pcs

100/0018

Taza tubo de borosilicato  
Borosilicate tube with handle

Ø 1.8 cm

24  
uds  
pcs

30  
ml

100/0028

Taza tubo de borosilicato  
Borosilicate tube with handle

Ø 1.6 cm

24  
uds  
pcs

20  
ml

100/0172

Tubo de ensayo maxi  
Maxi test tube

Ø 2,5 cm

Altura / Height: 25 cm

40  
uds  
pcs

90  
ml

100/0009

Tubos de ensayo de borosilicato  
Borosilicate labo tubes

Ø 1.6 cm Altura / Height: 15 cm

100  
uds  
pcs

20  
ml





## GRADILLAS ALUMINIO aluminium display

100/0011



12 x 12 cm  
Altura / Height: 6 cm

100/0012



22 x 12 cm  
Altura / Height: 7 cm

Ø 1.6 cm



## GRADILLAS PLEXIGLÁS methacrylate display

100/0019 Cristal / Clear

100/0020 Blanco / White

100/0021 Negro / Black

100/0025 Cristal / Clear

100/0027 Negro / Black

Ø 1.8 cm



100/0017

Escobilla para limpieza tubos de ensayo  
Cleaning brush for probe tubes







Cierre sus envases de yogurt con un toque de calor en un segundo.  
Close your yogurt pots with a touch of heat in just a second.



### BOTE VIDRIO YOGUR yogurt glass pot

100/0006	192 uds pcs	120 ml
100/0051	100 uds pcs	

### TAPA TERMOSELLABLE THERMO-SEALABLE LIDS

100/0007	Blanca / White	750 uds pcs
100/0136	Oro / Gold	600 uds pcs
100/0137	Plata / Silver	

Ø 6.2 cm



BOTES Y TAPAS  
PERSONALIZABLES  
CUSTOMIZABLE POTS  
AND COVERS





100/0056  
Logo Relief



100/0040  
Mini-print



100/0001  
Cuajada  
Ceramic Curd Pot  
Ø 7 cm Alt / Height: 8 cm

35 uds  
pcs

150 ml

100/0053  
Tapa termosellable blanca XL  
para Yogur de 400 ml y Cuajada  
White Thermo-sealable lid XL  
for 400 ml Yogurt & Curd pot

750 uds  
pcs

Para ref. / For ref.  
100/0052 & 100/0040  
Ø 8 cm

## JUMBO

Tutorial paso a paso para cerrar  
y personalizar los botes  
Step-by-step tutorial for closing  
and personalise the jars

**FREE EXTRA CONTENT**



36 uds  
pcs

100/0052  
Bote Yogur Jumbo  
Jumbo yogurt glass pots

400 ml

Ø 8 x 10 cm



# TAKE AWAY

100 uds  
pcs

100/0132  
Cajita Patatas Negra  
Fries Black Box

10 x 5 cm - Altura / Height: 12 cm



100 uds  
pcs

100/0222  
Cajita Patatas Negra XS  
XS Fries Black Box

6 x 3 cm - Altura / Height: 7 cm



100 uds  
pcs

100/0194  
Caja ensaimada mini  
Mini Ensamada Box

12 x 12 cm - Altura / Height: 2.5 cm



PERSONALIZABLES  
CUSTOMIZABLE



100 uds  
pcs

100/0098  
Mac Bit negro / Black Mac Bit

9 x 8 cm - Altura / Height: 5 cm



100 uds  
pcs

100/0197  
Caja pizza mini  
Mini pizza Box

9 x 9 cm - Altura / Height: 2 cm



100 uds  
pcs

100/0099  
Noodle Box XL

8 x 6 cm - Altura / Height: 7 cm



100 uds  
pcs

100/0034  
Noodle Box

5 x 5 cm - Altura / Height: 5 cm



100 uds  
pcs

100/0033  
Mac Bit blanco / White Mac Bit

9 x 8 cm - Altura / Height: 5 cm





# TAKE AWAY

100/0089  
Cocina de Vanguardia

29 x 30 cm

100/0090  
The New Fork Times

PAPEL DE PERIÓDICO  
NEWSPAPER

Hojas de papel parafinado simil  
periódico, impreso en tintas  
vegetales.

Puedes utilizarlo como envoltorio  
de sandwiches o bocadillos, patatas  
asadas, castañas o combinados con  
nuestras cestas de freidora o cajas  
de madera.

100/0118  
La Ración

Newspaper print wax paper printed  
with vegetable inks. Use it to wrap  
sandwiches, baked potatoes,  
chestnuts.

Or combined with our fryer baskets.  
Available in 4 Languages.

100/0119  
Food Times

100/0167  
Il Resto del Panino

100/0168  
Le Monde gastronomique





# CONOS DE CARTÓN

100 uds  
100 pcs

100/0066 Blanco · White Micro  
100/0067 Negro · Black

100/0043 Blanco · White XS  
100/0195 Kraft

100/0044 Blanco · White XL  
100/0196 Kraft





Descubra todas la opciones personalizadas

See all the options to customize your catering

**FREE EXTRA CONTENT**



# TAKE AWAY

## CONOS DE CARTÓN PERIÓDICO 100 uds NEWSPAPER CARDBOARD CONES pcs

100/0068	Micro
100/0091	XS
100/0003	XL
100/0122	XXL



XXL Ø 12 cm

25 cm

20 cm



## BAGAZO BAGASSE

La elección ideal para el servicio Take-away, comida a domicilio, hostelería, restauración, cáterings y eventos. Estos elementos son ecológicos, hechos de bagazo de caña de azúcar. Son resistentes a líquidos y aptos para horno y microondas, soportando temperaturas de hasta 190°C. Nuestra vajilla compostable es la alternativa más ecoamigable en cuanto a platos desechables se refiere. Se descomponen en menos de 6 meses, así que no solo no contaminan, sino que también enriquecen la tierra como abono.

The ideal choice for take-away, food delivery, hospitality, catering, and events. These items are eco-friendly, made from sugarcane bagasse. They are resistant to liquids and suitable for oven and microwave use, withstanding temperatures up to 190°C. Our compostable tableware is the most environmentally friendly alternative when it comes to disposable plates. They decompose in less than 6 months, so not only do they not pollute, but they also enrich the soil as compost.

100/0218  
Hoja Bagazo  
Bagasse Leaf

6 x 10 cm  
Alt / Height: 1 cm

100  
uds  
pcs



100/0217  
Limón Bagazo  
Bagasse Lemon

11 x 6 cm  
Alt / Height: 3 cm

100  
uds  
pcs



100/0213  
Plato Bagazo  
Bagasse Leaf

6 x 6 cm  
Alt / Height: 1 cm

100  
uds  
pcs



100/0219  
Cuchara Arch Bagazo  
Bagasse Arch Spoon

7 x 4 cm  
Alt / Height: 2 cm

100  
uds  
pcs



100/0214  
Bowl Bagazo  
Bagasse Bowl

7 x 7 cm  
Alt / Height: 5 cm

100  
uds  
pcs





**100/0216**  
Cazo Bagazo  
Bagasse Pot

3 x 9 cm  
Alt / Height: 5 cm

100 uds  
pcs



**100/0215**  
Sartén Bagazo  
Bagasse Pan

3 x 9 cm  
Alt / Height: 2 cm

100 uds  
pcs



Mussel Bagazo  
Bagasse Mussel

100 uds  
pcs

100/0220 XS 10 x 4 cm Alt / Height: 2 cm

100/0221 XL 10 x 5,5 cm Alt / Height: 2 cm



Egg Bagazo  
Bagasse Egg

100 uds  
pcs

100/0210 XL 20 x 14 cm Alt / Height: 7,5 cm

100/0211 M 11 x 7 cm Alt / Height: 3,5 cm

100/0112 XS 8 x 5 cm Alt / Height: 2,2 cm

# AGAVE STRAW

## Biodegradable

Pajitas biodegradables fabricadas con fibras vegetales provenientes del bagazo del ágave, consideradas desecho de la industria tequilera del mezcal, aportando características ideales para la elaboración del bioplástico. 100%reciclables son un aprovechamiento circular de un sobrante no alimentario. Resistentes a la humedad incluso 24 horas sumergidas en líquidos, ya sean frios, ácidos o a pleno calor. Muy probablemente, el mejor producto que pueda sustituir verdaderamente las cañitas de plástico.

Realmente económico e ideal para coctelerías, heladerías y todo tipo de bares.

Biodegradable straws made with vegetable fibers from the bagasse of the agave, considered waste from the tequila mezcal industry, providing ideal characteristics for the production of bioplastic. 100% recyclable, a circular use of a non-food waste, resistant to humidity even 24 hours submerged in liquids, cold, acids or high heat. Probably the best product that can truly replace plastic straws.

Really economical for cocktail bars, ice cream shop and all kinds of bars.

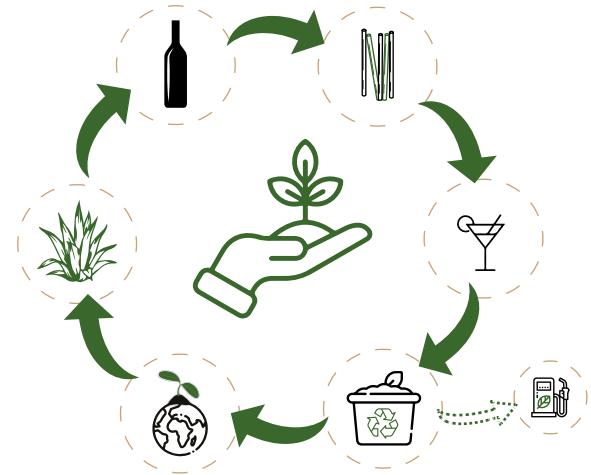

150 uds  
100/0209 Pajitas Ágave  
Agave Straws  
Alt / Height: 21 cm





**UNA ALTERNATIVA SUSTENTABLE A LOS PLÁSTICOS TRADICIONALES  
A SUSTAINABLE ALTERNATIVE TO TRADITIONAL PLASTICS**

**OLVÍDATE DEL PAPEL REBLANDECIDO  
FORGET ABOUT SOFTENED PAPER**



Frío y calor  
Hot & Cold

Alcoholes  
Alcohol

Ácidos  
Acids

Bebidas cálcicas  
Calcic Drinks

Sin sabor ni color  
No taste, no color







12 uds  
pcs

100/1018

Huevera codorniz 18 huevos  
Clear Plastic Quail Eggs Carton 18 eggs

15 x 11 cm

PAJITAS DE CARTÓN

CARDBOARD STRAW

100 uds  
pcs

PC/70111 Azul · Blue

PC/70112 Verde · Green

PC/70113 Naranja · Orange

PC/70114 Amarilla · Yellow

PC/70115 Rosa · Pink

Altura / Height: 19.5 cm



100/0198  
Kalippo

100 uds  
pcs

15 x 11 cm  
Incluye 125 tapas termosellables  
Includes 125 heat-sealable lids





BOTELLA REUTILIZABLE

REUSABLE BOTTLE

50 uds  
pcs

100/1143 500 ml 4 x 4 x 11 cm

100/1142 250 ml 5 x 5 x 13 cm

100/1141 125 ml 6,5 x 6,5 x 16 cm



PC/70811  
Cajita Brownie Azul  
Blue Brownie Box

100 uds  
pcs

4 x 4 cm Alt / Height: 6 cm



100/0165  
PopCorn Box

100 uds  
pcs

5 x 7 cm Altura / Height: 7 cm

ICE CREAM BOX

100 uds  
pcs

PC/70814 Rosa · Pink

PC/70815 Naranja · Orange

Ø 5 cm Altura / Height: 4.5 cm



## SOPORTES TARIMA TARIMA SUPPORTS

100/0092      Transparente / Clear

100/0093      Blanco / White

100/0094      Negro / Black



Medidas / Size: 6.5 x 6.5 cm - Altura / Height: 8.5 cm - Agujero / Hole: Ø 4 mm

100/0064  
Soporte redondo conos y brocheta  
Round stand for cone and skewer

Ø 3 cm    Alt / Height: 4.5 cm



100/0065  
Soporte redondo duplo para brocheta  
Double roundstand for skewers

Ø 3 cm    Alt / Height: 4 cm

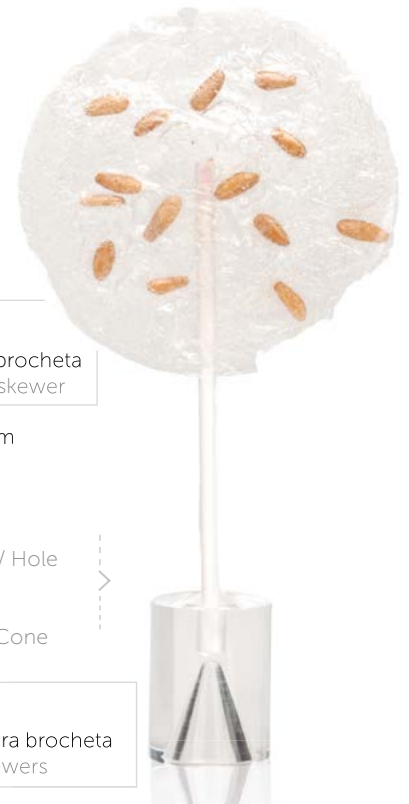

## BOLSA COCKTAIL COCKTAIL BAG

Bolsas de polipropileno transparente bi-orientadas con fuelle y fondo cuadrado plano. Aptas para todo uso alimentario, totalmente estancas y resistentes a cualquier manipulación.

Polypropylene bi-oriented bags with fold and plain square bottom. Suitable for any food connected use. Fully waterproof and resistant to any manipulation and liquids.



100/0170  
Drink Bag

100 uds  
pcs

Con tapón de seguridad, las Drink Bag permiten servir y contener todo tipo de bebidas, salsas o caldos fríos y calientes. Aptas para pasteurizar el producto en su interior.

With safety cap, the Drink Bag can be used to serve and contain all types of hot and cold drinks, sauces or broths. Suitable for pasteurizing the product inside.

COCKTAIL BAG

100 uds  
pcs

100/0150 8 x 5 cm - Alt / H: 24 cm

100/0152 6 x 5 cm - Alt / H: 17 cm

COCKTAIL BAG

1000 uds  
pcs

100/0151 8 x 5 cm - Alt / H: 24 cm

100/0153 6 x 5 cm - Alt / H: 17 cm

100/0002  
Paella Party

100 uds  
pcs

Ø 18 cm  
Altura / Height: 2 cm



Fabricada en polipropileno. Resiste al microondas hasta 85°C  
Manufactured in polypropylene. Microwave resistant up to 85°C



PERSONALIZABLES  
CUSTOMIZABLES

325 ml







PC/65311  
Mini botella de Cola  
Mini Cola Bottle

36 uds  
pcs

50 ml

Ø 3,5 cm Alt / Height: 11 cm



100/0096  
Botella de leche miniatura  
Milk Bottle Miniature

36 uds  
pcs

40 ml

Ø 3 cm Alt / Height: 9 cm



160/5098  
Pajitas Ambar  
Ambar Straws

24 uds  
pcs

Ø 0,8 cm  
Alt / Height: 21 cm



160/5100  
Droppers

24 uds  
pcs

50 ml

Ø 3,5 cm  
Alt / Height: 12 cm

160/5097  
Botella Ambar  
Ambar Bottle

24 uds  
pcs

250 ml

Ø 6,5 cm  
Alt / Height: 13 cm



PERSONALIZABLES  
CUSTOMIZABLES

160/5003  
Petaca SpeakEasy  
SpeakEasy Hip Flask

24 uds  
pcs

200 ml

8 cm x 5 cm Alt / Height: 15 cm



30 ml



Tarro confitura mini  
Mini jam jar

105 uds  
pcs

100/0115 Oro / Gold

100/0116 Negro / Black

Ø 4,5 cm

160/5099  
Mini Petaca SpeakEasy  
SpeakEasy Hip Flask

24 uds  
pcs

100 ml

3 cm x 6,5 cm Alt / Height: 13 cm



PC/ 65309  
Mini botella de gaseosa  
Mini Soda Bottle

72 uds  
pcs

50 ml

Ø 5,5 cm Alt / Height: 11 cm





10 uds  
pcs

130/0010  
Spray polvo - Cabezal Oro  
Powder Spray - Gold Head

Muy útil para cappuccino, bombonería, emplatados muy precisos y delicados de esencias en polvo mezcladas con maltodextrinas, etc.  
¡Pruebe a espolvorear el algodón de azúcar mientras lo enrolla!

Very useful for cappuccino, bonbons, very precise and delicate plating of powdered essences mixed with maltodextrins, etc.  
Try sprinkling the cotton candy while rolling!



PETRI

160/5056	Ø 6 x 2 cm	12 uds/pcs
160/5057	Ø 8 x 2 cm	10 uds/pcs
160/5058	Ø 10 x 2 cm	8 uds/pcs
160/5059	Ø 15 x 3 cm	6 uds/pcs



PC/65402  
Mini Spray

24 uds  
pcs

Ø 2 cm

15 ml

10 cm



2 X 1



40 ml

70 ml

130 ml

350 ml

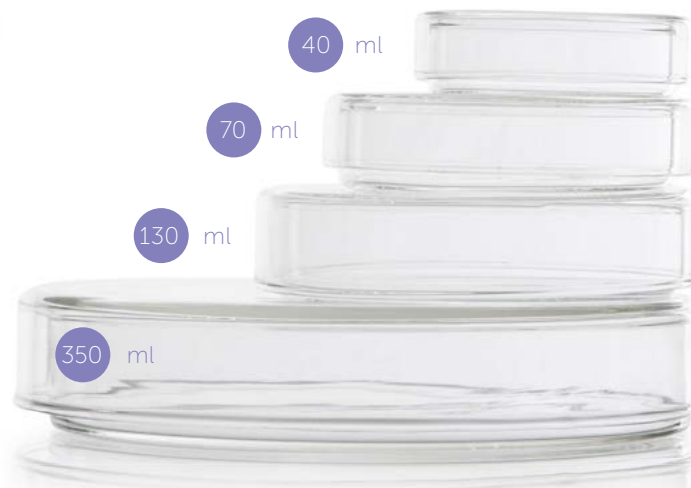



**PC/65307**  
Mini campana  
con base  
Display stand  
with mini cloche

Ø 8 cm  
Altura / Height: 17 cm



**PC/65310**  
Vasito recto de doble pared  
Straight Double Wall Mini Glass

30 ml

Ø 5,5 cm  
Altura / Height: 5,5 cm



**160/5002**  
Vasito Semisphere  
Semisphere Glass

2 uds  
pcs

100 ml

Ø 6 cm  
Alt / Height: 7 cm



**PC/65300**  
Mini tetera  
Mini Teapot

150 ml

13 cm

5 cm



# GINTONIC CONCEPT

El Gin Tonic lo haces tú!  
Gin Tonic made by you!



100/0073  
Botella cristal  
Glass bottle

24 uds  
pcs

200 ml

Ø 5 cm  
Altura / Height: 18 cm



Tutorial GinTonic  
Concept Online



FREE EXTRA CONTENT

Corona chapas  
Crown bottle caps

100 uds  
pcs

100/0075 Oro · Gold

100/0077 Rojo · Red

100/0076 Verde · Green

100/0078 Plata · Silver





**100/0142**  
 Prensa Cierra Botellas  
 Corcho y Corona  
 Sealing Press For Bottles  
 With Corks And Caps



**100/0143**  
 Tapon Corcho Cava  
 Corks for Champagne Bottle

50 uds  
 pcs

**100/0143**  
 Tapon Corcho Cava  
 Corks for Champagne Bottle



**100/0147** Negro · Black  
**100/0148** Plata · Silver

100 uds  
 pcs

**100/0147**  
 Corona champagne  
 Champagne Muselet



**100/0144**  
 Cerrador de Bozales  
 Muselet Closer



**100/0145**  
 Cepillo limpia botellas  
 Bottle Cleaning Brush

## CHAMPAGNE CONCEPT



**100/0141**  
 1/2 Botella Spumanti  
 1/2 Spumanti Bottle

6 uds  
 pcs

500 ml

Ø 5.5 cm  
 Altura / Height: 25 cm



LAVABLE  
 WASHABLE



PERSONALIZABLES  
 CUSTOMIZABLES

Miniaturas / Miniatures

Cazuelas y sartenes de acero esmaltado de alta calidad y en formato miniatura. Gran resistencia al uso cotidiano, permiten cocinar a fuego de gas, eléctrico, inducción y horno. Además pueden ser lavados en el lavavajillas. Ideal para presentar los platos o medias raciones de cocina tradicional.

Wide range of miniature pots and pans made of high-quality enameled steel. High resistance to daily use. Allows cooking with gas, electric, or induction hobs and oven. Dishwasher-safe. Ideal for presenting full or half portions of traditional cuisine.

Fuente teja  
Russet Oven Pan with handles

220/0001	XS	Ø 12 cm	250 ml	12 uds pcs
220/0101	XL	Ø 14 cm	310 ml	



Cacerola teja  
Russet Stewpan

220/0002	XS	Ø 10 cm	300 ml	6 uds pcs
220/0003	M	Ø 12 cm	500 ml	
220/0203	XL	Ø 14 cm	700 ml	



Olla teja  
Russet Round Cooking Pot

220/0005	XS	Ø 12 cm	750 ml	4 uds pcs
220/0105	XL	Ø 15 cm	1.5 L	





Kit 4 Pcs Mono-uso  
Kit 4 Pcs Mono-uso

C8338	Cuchillo, Tenedor, Cuchara + Servilleta Knife, Fork, Spoon + Napkin	120	uds pcs
C8184	Cuchillo, Tenedor, Cuchara café + Servilleta Knife, Fork, Tea Spoon + Napkin	50	uds pcs

Set de cubiertos inoxidable para un solo uso embolsados unitariamente  
Stainless steel cutlery set for single use, individually bagged



0,6mm



P/50003  
Sisi Tendedor Mini  
Mini Clothes Line "Sisi"

24 x 11 cm  
Altura / Height: 16 cm

100 uds  
100 pcs  
PC/68588  
Pinza Tendedor Mini  
Clothesline Tongs

Largo / Long: 3 cm



Pallet

PC/66300	Mini	12 x 12 cm	Alt / Height: 1 cm	5	uds pcs
PC/66303	Medium	20 x 12 cm	Alt / Height: 2 cm		
PC/66305	Long	45 x 15 cm	Alt / Height: 3 cm	1	ud pc





Rotulables  
Writable

100 uds  
pcs

PC/68549

Brocheta Pizarra / BlackBoard Skewer / 15 cm  
pizarra / slate board: 5 x 3.5 cm

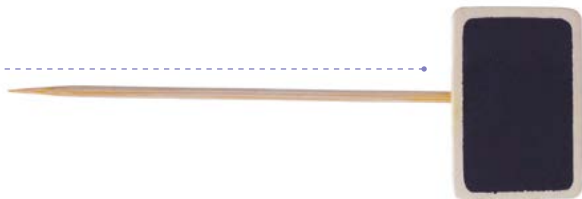

100 uds  
pcs

PC/68558

Brocheta Twister / Twister Skewer / 12.5 cm

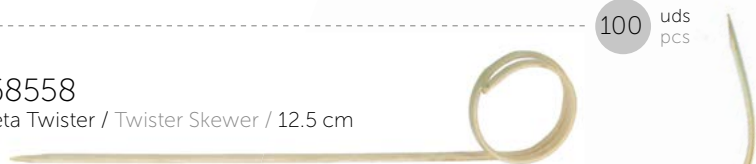

100 uds  
pcs

PC/68559

Brocheta Ying-Yang  
Ying-Yang Skewer  
11.5 cm

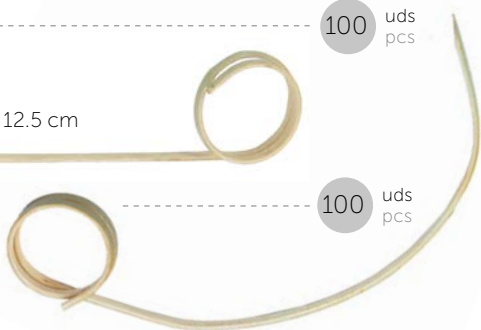

100 uds  
pcs

PC/68620

Brocheta LOOPING / LOOPING skewer  
18 cm

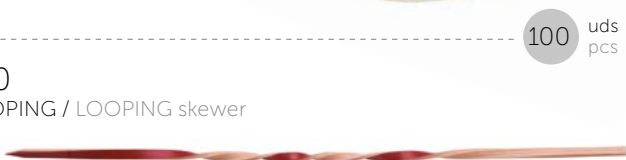

100 uds  
pcs

Brocheta Cuore Natura / Cuore Natura Skewer

PC/68521  
18 cm

PC/68524  
10 cm



PC/68561

Palillo bolita amarilla  
Yellow ball skewer / 9 cm



100 uds  
pcs

PC/68586

Palillo bolita verde  
Green ball skewer / 9 cm



100 uds  
pcs

PC/68587

Palillo bolita azul  
Blue ball skewer / 9 cm



100 uds  
pcs

Brocheta Noshi / Noshi Skewer



100 uds  
pcs

PC/68535  
18 cm

PC/68536  
15 cm

PC/68539  
5 cm

Brocheta Teppo / Teppo Skewer



100 uds  
pcs

PC/68540  
18 cm

PC/68534

Brocheta Matsubagushi  
Matsubagushi Skewer / 9 cm



100 uds  
pcs

Brocheta Cuore Color / Cuore Color Skewer

PC/68525  
18 cm

PC/68527  
12 cm



100 uds  
pcs

PC/68675

Cuchara bambú

Bamboo Spoon / 10 cm

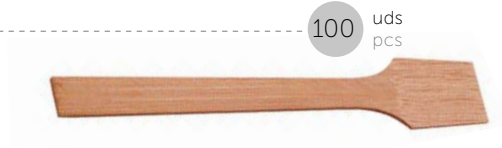
100 uds  
pcs

PC/68576

Pinza bambú mini / Bamboo mini-tongs  
7 cm10 uds  
pcs

PC/68662

Mini plato ovalado bambú

Genuine bamboo oval plate  
5.5 x 7.5 cm10 uds  
pcs

PC/68511

Barquita pequeña bambú / Small bamboo tray  
7.5 x 4 cm Alt / Height: 1 cm100 uds  
pcsCono bambú  
Bamboo Cone

PC/68500

Grande / Big

Ø 8 cm

Alt / Height: 12.5 - 16.5 cm

PC/68501

Mediano / Medium

Ø 5 cm

Alt / Height: 9 - 13 cm

PC/68502

Pequeño / Small

Ø 4.5 cm

Alt / Height: 6 - 8.5 cm

100 uds  
pcs

PC/68516

Vasito pequeño bambú

Small bamboo cup

Ø 4.5 cm

Alt / Height: 4.5 cm

100 uds  
pcs

PC/68761  
Vaporera Bambú  
Bamboo Steamer  
Ø 15 x 9 cm

4 uds  
pcs



PC/68760  
Bowl Coco  
Coconut Bowl

10 uds  
pcs

8 x 11 cm  
Altura / Height: 4 cm



 PERSONALIZABLES  
CUSTOMIZABLES



150/0006  
Palito polo  
Popsicle Wood Stick



150/0007  
Palito bombón helado  
Ice Cream Wood Stick



150/0008  
Palito mini bombón helado  
Mini Ice Cream Wood Stick

Caoba / Mahogany



100/2011  
Caja "Curruncho"  
"Curruncho" Trunk

Ø 22 cm Alt / Height: 11 cm



Pivota sobre un eje  
Pivots on an axis



Ligeramente cóncavo, especial para salsas  
Slightly concave, especially for sauces

100/2012  
Plato Caoba Slice  
Caoba Slice Plate

Ø 28 cm Alt / Height: 1,5 cm  
+/- 2 cm

6 uds  
pcs



Con pies de madera para facilitar su manipulación  
With wooden feet for easy handling





5 uds  
pcs

PC/66301  
Caja fruta mini  
Mini Fruit Box

15 x 9 cm  
Altura / Height: 7 cm



## Cajas marisco / Seafood Boxes

Presente marisco y pescado como en las cajas de productos fresco que se vende en los mercados y pescaderías. Junto a la caja de metacrilato que encaja perfectamente en ésta puede servir los alimentos con hielo, con nieblas de nitrógeno, hielo seco o con humo frío.

Present seafood and fish as in the boxes you can find in the markets or fish markets. Wooden boxes with logo printed in Spanish on one side and in English on the other. Use with the methacrylate box that fits this box perfectly. You will be able to serve food with ice, fog nitrogen smoke or even dry ice.

8 uds  
pcs

100/2001  
Caja marisco  
Seafood Box

21 x 13 cm  
Altura / Height: 5 cm



## Caja metacrilato marisco Seafood Methacrylate Box

100/2002 1K 18 x 12 cm Altura / Height: 5 cm

100/2006 2K 27 x 18 cm Altura / Height: 7 cm

100/2007 3K 37 x 29 cm Altura / Height: 6.6 cm

Diseñada para encajar perfectamente y servir los alimentos con hielo, con nieblas de nitrógeno, hielo seco y humo frío.

Designed to fit perfectly and serve food with ice, nitrogen or dry ice mist and cold smoke.



2K



3K



## Caja marisco impresa Seafood Printed Box

100/2000 1K 21 x 13 cm Altura / Height: 5 cm 8 uds pcs

100/2004 2K 30 x 20 cm Altura / Height: 8.5 cm 5 uds pcs

100/2005 3K 40 x 30 cm Altura / Height: 7 cm 3 uds pcs

Caja impresa en español e inglés / Box printed in Spanish and English





BBQ  
Barbacoas  
Barbecues





## BARBACOA CALIU CALIU BARBECUE

Caliu es un conjunto de barbacoa y accesorios diseñados para crear experiencias gastronómicas completas y únicas.

Con un diseño actual y fácil de usar, ofrece un equilibrio perfecto entre estética y funcionalidad, imprescindible en un entorno profesional de cara al cliente.

Permite múltiples técnicas y cocciones, lo cual la hace muy versátil.

Fabricada 100% con acero inoxidable, sin ensamblajes ni partes móviles.

Caliu is a set of barbecue and accessories designed to create unique gastronomic experiences.

With a modern and easy to use design, it offers a perfect balance between aesthetics and functionality, essential in a professional environment.

It allows multiple techniques and cookings, which makes it very versatile.

Made of 100% stainless steel, with no assemblies or moving parts.



Caliu se compone de 3 áreas: barbacoas, accesorios y servicio de mesa. Con ellos, se puede presentar la brasa de una forma óptima y elegante.

Caliu consists of 3 areas: barbecues, accessories and table service. With them, the grill can be presented in an optimal and elegant way.



Los mejores restaurantes y Chefs ya utilizan Caliu  
The best restaurants and Chefs already use Caliu

# CALIU

BARBACOAS / BARBECUES



C8684  
BBQ Caliu Catering

30 x 86 cm  
Alt / Height: 16 cm



El embellecedor reversible permite elegir dos alturas diferentes para cocinar.  
With the convertible outer house, you may choose between two different cooking heights.

## EN TODAS PARTES

Cree una experiencia interactiva colocando Caliu en el centro de la mesa de su terraza para que los comensales disfruten cocinando o terminando sus propias piezas. Mantenga un servicio de c atering con show cooking al m aximo nivel con una alta eficiencia y producci on.

## EVERYWHERE

Create an interactive experience by placing Caliu in the center of your terrace table for diners to enjoy cooking or finishing their own pieces. Maintain a show cooking catering service at the highest level with high efficiency and production.



C8500  
BBQ Caliu Horeca

30 x 45 cm  
Alt / Height: 16 cm





# CALIU

ACCESORIOS / ACCESSORIES



La tapa crea el efecto horno, cocinando los productos como si se tratase de un horno y potenciando los aromas y sabor a humo.

Añada unas ramitas de hierbas aromáticas frescas o maderas humedecidas para dar el toque a todos los platos.

The lid creates the oven effect, cooking the products as if they were in an oven, and enhancing the aromas and smoke flavor, add a few sprigs of fresh aromatic herbs or damp wood to give a touch to all of your dishes.



C9969

Tapa BBQ

BBQ lid

26 x 37 cm

Alt / Height: 14 cm





Compactas barbacoas portátiles,  
ligeras y aptas para poner sobre una  
mesa.

Dispone de accesorios que permiten  
distintas técnicas culinarias y cocciones  
precisas.

Son ideales para el showcooking, ya  
que estan diseñadas para ser vistas.

Compact portable barbecues, light and  
suitable to be placed on a table.

It has accessories that allow different  
cooking techniques and precise  
cooking.

They are ideal for showcooking, as  
they are designed to be seen.

# CALIU

SOBREMESA / TABLE WARE



Plato brasa  
BBQ plate

C8181 S 14 x 25 cm Altura / Height: 8 cm

C8685 M 14 x 36 cm Altura / Height: 8 cm



C8687  
Pinza BBQ  
BBQ tong  
26 cm



C8686  
Chimenea BBQ  
Chimney BBQ

8 x 12,5 cm  
Alt / Height 30 cm







## BARBACOAS KASAI KASAI BARBECUES

Viaje a las calles de Osaka con esta versión profesional mejorada de las típicas barbacoas de cerámica Konro japonesas. Construidas con estructura reforzada de acero inoxidable, chasis compacto y robusto, están revestidas de vermiculita, un mineral natural muy ligero que se caracteriza por su capacidad de retención del calor, logrando temperaturas de hasta 1.200°C / 2.200°F más estables e intensas.

Gracias su efecto aislante, este material permite que el carbón arda por más tiempo sin producir fugas.

Son extremadamente ligeras, lo que las hace fácilmente transportables y ágiles de manejar, siendo perfectas para su instalación en cualquier cocina, buffet o catering. Disponemos de diferentes tamaños y accesorios para sacar el máximo de partido a esta forma natural de cocción.

No incluye base aislante de vermiculita  
Heat mat not included  
Incluye rejilla de cocción  
Includes a cooking grid

180/0012  
BBQ Kasai Large

26 x 70 cm Alt / Height: 21 cm

Take a journey to the streets of Osaka with this upgraded professional version of the typical Japanese Konro ceramic barbecues. Constructed with a reinforced stainless steel structure and a compact, sturdy chassis, they are coated with vermiculite, a natural mineral known for its lightweight and heat retention properties, achieving more stable and intense temperatures of up to 1,200°C / 2,200°F.

Thanks to its insulating effect, this material allows the charcoal to burn for longer periods of time without producing leaks. They are extremely lightweight, making them easy to transport and handle, making them perfect for installation in any kitchen, buffet, or catering service.

We offer different sizes and accessories to make the most of this natural cooking method.



Parrilla de cocción  
Cooking mesh

Asas de acero inoxidable  
Stainless steel handles

Vermiculita  
Vermiculite

Ranuras de ventilación deslizantes  
Sliding air vents

Acero inoxidable cepillado  
Brushed stainless steel

Ladrillo refractario  
Fire brick

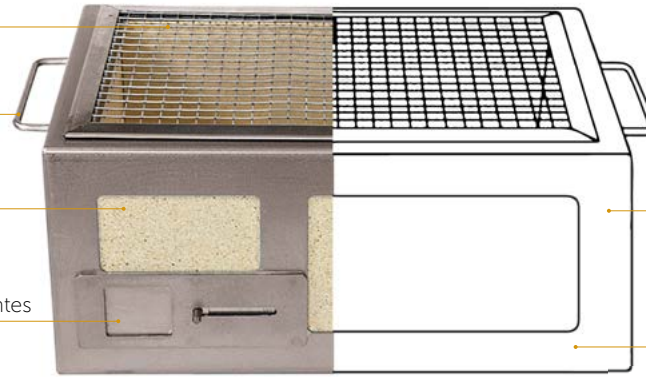

**107°C**  
**350°C**

Temperatura de trabajo  
Working temperature

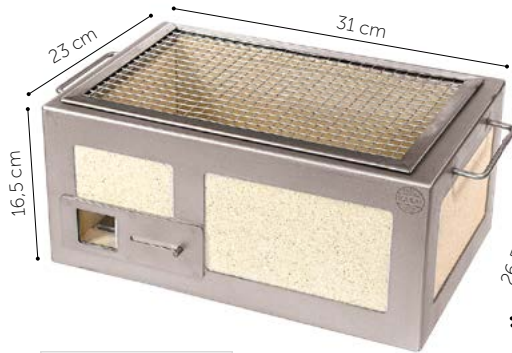

180/0009  
BBQ Kasai Nano



180/0010  
BBQ Kasai Small



180/0011  
BBQ Kasai Medium



## ACCESORIOS KASAI KASAI ACCESSORIES

Utilice las planchas Kasai en su parrilla. Elaboradas con acero inoxidable y con una temperatura de trabajo de 107°C a 350°C, son el complemento ideal para asar carnes, pescados, verduras o terminar un plato cocinado al vacío. El soporte de brochetas, permite cocinar sin necesidad de levantar las brochetas para girarlas. Una vez encajadas se pueden girar 360° para asegurar una cocción uniforme.

Use Kasai griddles on your grill. Made of stainless steel and with a working temperature of 107°C to 350°C, they are the ideal complement for grilling meats, fish, vegetables or finishing a dish cooked under vacuum. The skewer support, allows you to cook without having to lift the skewers to turn them. Once inserted, they can be rotated through 360° to ensure even cooking.



### Skewers Kasai

180/0032 SMALL 33 x 1,8 cm

180/0033 LONG 44 x 1,8 cm



### Plancha 50:50

180/0016 NANO 35 x 24 x 7 cm

180/0017 SMALL 40 x 24 x 7 cm

180/0018 MEDIUM 47 x 30 x 8 cm



### Soporte + 6 Espadas Kasai Skewers rack with 6 Swords

180/0028 NANO 35 x 24 x 7 cm

180/0029 SMALL 40 x 24 x 7 cm

180/0030 MEDIUM 47 x 30 x 8 cm





Malla de repuesto  
Spare mesh

180/0019	NANO	23 x 31 x 2 cm
180/0020	SMALL	40 x 26 x 2 cm
180/0021	MEDIUM	46 x 35 x 2 cm
180/0022	LARGE	70 x 26 x 2 cm



Base aislante de vermiculita  
Vermiculite heat mat

180/0023	NANO	23 x 31 x 2 cm
180/0024	SMALL	40 x 26 x 2 cm
180/0025	MEDIUM	46 x 35 x 2 cm
180/0026	LARGE	70 x 26 x 2 cm

Proteja la superficie que utilice para cocinar con la Kasai Konro Grill.

Protect the surface you use to cook with the Kasai Konro Grill.





## CARBÓN / CHARCOAL

# CALIU

El carbón de cáscaras de coco naturales Caliu se presenta en forma de briquetas cúbicas.

Es perfecto por su alto poder calorífico estable, de larga duración, sin llama, sin chispas y muy poco humo.

Caliu's natural coconut shell charcoal comes in the form of cubic briquettes. It's perfect due to its high and stable heat output, long-lasting burn time, flameless and sparkless properties, as well as producing very little smoke.

C10803  
Carbón 5 kg  
Charcoal 5 kg



C10805  
Pastilla de encendido  
Ignition tablet

80 x 125 cm  
Alt / Height: 30 cm



24 uds  
pcs



C10804  
Carbón 10 kg  
Charcoal 10 kg



180/0027  
Carbón Sumi Bincho 10 kg  
Sumi Bincho Charcoal 10 kg

Sumi Bincho está hecho de maderas duras y densas según los métodos de producción tradicionales de la cultura japonesa. Arde a una temperatura más baja y durante periodos más largos que el carbón ordinario. No produce olor, por lo que es ideal para sellar los sabores naturales.

Sumi Bincho is made from dense hardwoods using traditional production methods from Japanese culture. It burns at a lower temperature and for longer periods of time than regular charcoal, and doesn't produce any odors, making it ideal for sealing in natural flavors.





Acabado de pintura resistente al calor hasta 600°C: fácil de limpiar y mantener.

Heat-resistant up to 600°C. paint finish for an easy cleaning and maintainance.



180/0006  
Barbacoa Mini  
Mini Barbecue

16 x 16 cm  
Alt / Height: 13 cm



180/0003  
Barbacoa de sobremesa  
Tabletop barbecue

25 x 20 cm  
Alt / Height: 13 cm

MINIATURES  
**BBQ**  
MINIATURAS



180/0004  
Parrilla de sobremesa  
Tabletop barbecue

25 x 20 cm  
Alt / Height: 11 cm







Inox

Creatividad inoxidable  
Stainless creativity





P/44020  
Pinza degustación  
Tasting tong

20 cm



Pinza cangrejo  
Crab tong

P/44017 15 cm

P/44018 20 cm



MAX PRECISION



PERSONALIZABLE  
CUSTOMIZABLE

P/34043W\*  
Pinza Sushi Lacado Blanco  
White Lacquered Sushi Tongs

20 cm



Acabado brillo  
Glossy finish

P/34036MB\*  
Pinza Sushi Lacado Negro Mate  
Black Lacquered Mate Sushi Tongs

MB

Teflon Non-Stick

P/34044 Sushi MB Non-Stick

P/34045 Sushi Non-Stick

Acabado satinado  
Satin finish

20 cm





CREA TU PINZA ESPECIAL  
MAKE YOUR SPECIAL TONGS



Fantasy\*

P/34104 Rosa / Pink

P/34105 Gris / Grey

20 cm

Acabado mate  
Color degradado  
Matte finish  
Gradient color



Solid Color Matte Finish\* 20 cm

P/34100 Bourdeos / Burgundy

P/34102 Verde botella / Kelly Green

P/34036MC Negro / Black

P/34101 Mandarina / Tangerine

P/34103 Azul marino / Marine blue



## SPECIAL BARMAN

Pinza Barman Titanium  
Barman Titanium tong  
30 cm

P/34016-G | P/34016-C | P/34016-N  
Dorada / Gold | Cobre / Copper | Negro / Black

## P/34016

Pinza larga Chef  
Chef's long serving tong  
30 cm

P/34015 | P/34014 | P/34012  
25 cm | 20 cm | 16 cm



Saber más en / Know more on:  
[www.100x100barman.com](http://www.100x100barman.com)

**100% Barman**



PERSONALIZABLE  
CUSTOMIZABLE

## P/44014

Pinza Larga Retail 20 cm  
Retail Serving Long Tongs





Punta en forma de diamante con interior serrado pulido  
Diamond-shaped tip with serrated grip  
Matte finish

P/54037  
Pinza ELITE Sushi Giant  
ELITE Sushi Giant tong  
30 cm



**"ELITE"**  
PINZAS RECTAS  
CHEF SERVING TONGS

**Pinzas ELITE**  
ELITE Chef Serving Tongs

Fabricadas en acero inoxidable AISI 316, la mejor calidad posible de acero inoxidable para uso alimentario. Diseño especial para emplatado, que permite aún más efectividad y precisión, juntando comodidad y delicadeza. Brazos con acabado antideslizante y ergonómico.

Made with AISI 316, the best stainless steel alloy for food contact. Specially designed for creative plating, to ensure effectivity and precision, it allies comfort and delicacy. Arms with ergonomic and non-slip handles.

P/54012  
16 cm



P/54014  
20 cm



P/54016  
30 cm





## Pinzas Sushi Titanio-Color Titanium color Sushi Tongs

Las pinzas de emplatado más vendidas del momento, acabadas con un baño de titanio coloreado en 5 colores inalterables. El titanio confiere la dureza y resistencia necesaria exigida para el uso profesional diario.

The most popular plating tongs of the moment, titanium plated in 5 unalterable colors. Titanium plating gives it the hardness and resistance needed for daily professional use.

P/34043-N	Negro / Black	20 cm
P/34043-P	Púrpura / Purple	
P/34043-B	Azul / Blue	
P/34043-C	Bronce / Bronze	
P/34043-G	Dorado / Golden	

P/34007-N	Negro / Black	14 cm
P/34007-P	Púrpura / Purple	
P/34007-B	Azul / Blue	
P/34007-C	Bronce / Bronze	
P/34007-G	Dorado / Golden	

P/84036  
Pinza Sushi GOLD  
GOLD Sushi tongs

20 cm



P/34043  
Pinza Sushi Titanium  
Titanium Sushi Tong

20 cm

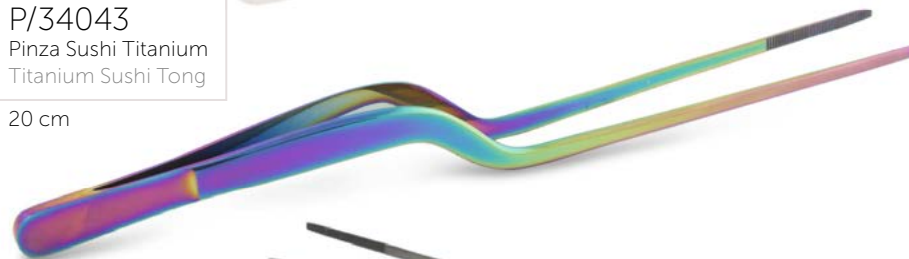

PERSONALIZABLE  
CUSTOMIZABLE

P/64255  
Soporte inox para pinzas Sushi  
Stainless Steel Stand for Sushi Tongs





P/44036  
Pinza Sushi Retail  
Retail Sushi Tongs



PERSONALIZABLE  
CUSTOMIZABLE

Pinza Sushi & Sashimi  
Sushi & Sashimi Tongs

P/34007 | 14 cm

P/34036 | 20 cm



P/64000  
Kit de emplatado Top Chef  
Top Chef Plating Set

Incluye referencias:  
Items included:

- Pinza "KAPABASHI"
- Pinza "SUSHI" 20 cm
- Pinza larga "CHEF" 20 cm
- Espátula flexible 20 cm
- Espátula dosificadora

- "KAPABASHI" tongs
- "SUSHI" 20 cm tongs
- Chef's tongs 20 cm
- Flexible 20 cm spatula
- Dosing spatula





### Tripod

P/68637 Oro / Gold

P/68638 Plata / Silver

P/68639 Negro Mate / Black Matte

7 x 7 x 11.5 cm



Dé un nuevo enfoque a sus presentaciones. El soporte trípode es utilizable en 3 diferentes posiciones según el producto a exponer.

Give a new approach to your presentations. The tripod stand can be used in 3 different positions depending on the product to be shown.



Perfecto para encajar en los soportes de piedra p.141  
Perfect to fit the stones supports p. 141

### Loop

P/68644 XS 18 cm

P/68645 XL 24 cm

Ø 5 cm



Ideal para pipetas  
Perfect with pipettes: p. 329



P/68647  
Pinza con Soporte para Guarniciones  
Clamp with Garnish Support



P/68648  
Soporte Guarnición para Copas  
Garnish Glass Support



P/68646  
Pinza con Soporte para Conos  
Clamp with Cone Support





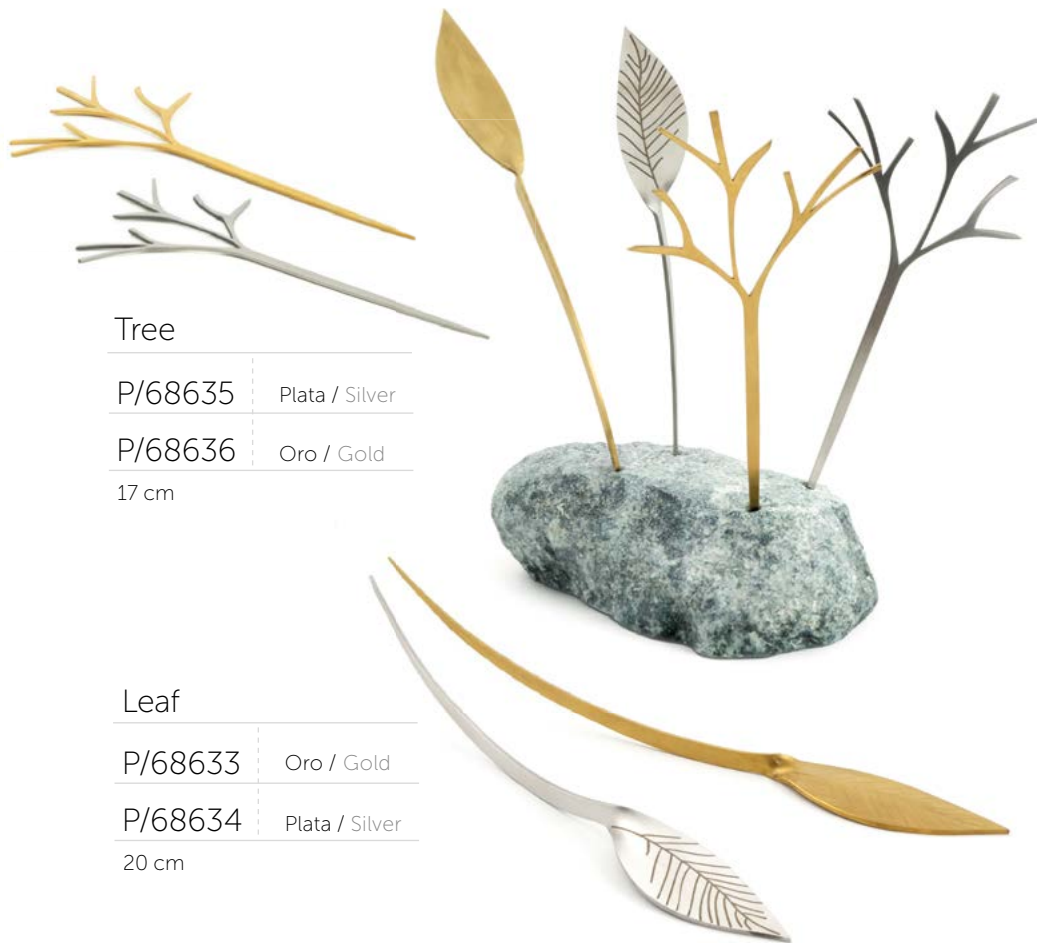

Tree

P/68635 Plata / Silver

P/68636 Oro / Gold

17 cm

Leaf

P/68633 Oro / Gold

P/68634 Plata / Silver

20 cm

En combinación con / Combined with:

Soporte piedra / Stone support: 190/0061

C6980  
Cocktail Stick  
Stainless steel

10 cm

C1543  
Cocktail Stick  
Gold

C1559  
Cocktail Stick  
Copper

C8643  
Cocktail Stick  
Black

C6981  
Large Stick  
Stainless steel

13 cm

C1544  
Large Stick  
Gold

C1560  
Large Stick  
Copper

C8644  
Large Stick  
Black

P/64226  
Brocheta Fjord / Fjord skewer  
18 cm

P/64630  
9 cm

P/64629  
7 cm

P/64910  
Brocheta TEPPPO / TEPPPO skewer  
15 cm

P/64911  
10.5 cm

P/68631  
Brocheta Cubik / Cubik skewer  
10 cm

P/68632  
Brocheta Tube / Tube skewer  
10 cm



## Malla Inox Stainless Steel Mesh

Malla en forma de tapete fabricado en acero inoxidable 18/10 alimentario, permite ser doblado y formado como un soporte a medida para cada plato. Infinitas formas y recursos para el emplatado de aperitivos, postres y degustaciones. Lavable en lavavajillas.

Mat-shaped mesh made of 18/10 food grade stainless steel. It can be folded and shaped as you wish, creating a custom holder for each dish. Create infinite shapes to serve appetizers, desserts and tastings. Dishwasher safe.



## Malla Inox Stainless Steel Mesh

P/50000 Fina / Fine

P/50001 Media / Medium

P/50002 Gruesa / Thick

25,5 x 17,5 cm





Labyrinth XL

P/68642 Oro / Gold

P/68643 Plata / Silver

22 x 15 x 11 cm - Ø 3 cm



Labyrinth XS

P/68640 Oro / Gold

P/68641 Plata / Silver

20 x 14 x 10 cm - Ø 2 cm



10 uds pcs  
20/0004  
Cuchara Lotus INOX  
Lotus Spoon INOX

20/0011  
Kit cucharas esferificación  
Spherification Spoons Kit



20/2004  
Cuchara Lotus GOLD  
GOLD Lotus Spoon



Baño de oro 14 KT  
14KT Gold coating

P/34034

Pinza quitaespinas pescado  
Fishbone tweezers  
12 cm



P/34031

Alicate Espinas Pescado  
Fishbone Pliers  
15 cm



P/34040

Pinza quitaespinas Kapabashi  
Kapabashi fishbone tweezers  
12 cm



P/44040

Pinza Quitaespinas Kapabashi Retail  
Retail Kapabashi Fishbone Tongs



P/64110

Rompemariscos con cierre  
Shellfish Cracker  
18 cm



P/64120

Rompemariscos Hostelería  
Shellfish Cracker  
18 cm

Ice Cream Spoon

10 uds  
pcs

P/68023 Mate / Matte

P/68022 Brillante / Glossy

9.5 x 2 cm



12 cm

P/64730

Abridor de huevos  
Hen egg top cutter



P/44730

Abridor de huevos Retail  
Retail Hen Egg Top Cutter



P/64502

Rasqueta para emplatar  
Cooking scraper spatula  
17 cm



P/64504

Espátula recta / Straight spatula  
19 cm



P/64503

Espátula dosificadora / Dosing mini-spatula  
16 cm



P/64270

Set de espátulas  
Plating spatulas kit

Incluye referencias:  
Includes references:

P/64500  
P/64501  
P/64502



P/64501

Horquilla para emplatar inox / Forked spatula  
19 cm



P/64505

Espátula ancha / Wide spatula  
19 cm

Pala / Spatula:  
13 x 4 cm



P/64500

Espátula para emplatar inox  
Mini flexible serving spatula  
19 cm

Pala / Spatula: 13 x 2 cm



P/64593

Vaciador miniquenelles óvalo  
Oval quenelle baller  
0.5 x 12 cm



P/64594

0.8 x 18 cm

P/64596

Vaciador doble / Double micro-quenelle baller  
Esfera / Sphere Ø 1.2 cm  
Óvalo / Oval: 0.8 cm



P/64597

Estuche 5 vaciadores, surtido  
bolita microquenelle  
5 mini-ball and micro-quenelle  
baller box

Incluye referencias:  
Items included:

P/64590  
P/64591  
P/64592  
P/64593  
P/64594



P/64590

Vaciador microbolitas  
Miniballer  
Ø 8 mm



P/64591

Ø 12 mm



P/64592

Ø 15 mm



## Perfect Quenelle

Elabore perfectas quenelles de helado ya que su simetría así lo permite. Con un mango extremadamente resistente permite trabajar incluso con helados duros. Al ser más grueso de lo normal retiene mejor la temperatura dejando las quenelles mucho más lisas.

Produce perfect ice cream quenelles with exact symmetry. With a highly resistant handle that allows you to work with very hard ice cream. The bowl of the Perfect Quenelle is heavier and thicker than the one of an usual spoon, helping it to retain longer the temperature.

P/64595

Perfect Quenelle XS  
4 x 2.5 cm



P/64598

Perfect Quenelle M  
5 x 3 cm



P/64599

Perfect Quenelle XL  
6 x 4 cm





### P/68011

Plancha inox para 24 brochetas (foam incluido)  
Display board for 24 skewers (foam included)  
49 x 9 x 1 cm



### P/68012

Plancha inox para 4 brochetas (foam incluido)  
Display board for 4 skewers (foam included)  
15 x 5 x 1 cm

### P/68014

Foam recambio para plancha inox P/68012  
Spare foam board for display P/68012  
14.9 x 4.9 x 1 cm

### P/68001

Plancha inox para 169 brochetas (foam incluido)  
Display board for 169 skewers (foam included)  
30 x 30 x 1 cm

### P/68000

Foam recambio para plancha inox P/68001  
Spare foam board for display P/68001  
29.9 x 29.9 x 1 cm



### P/68013

Foam recambio para plancha inox P/68011  
Spare foam board for display P/68011  
48.9 x 8.9 x 1 cm

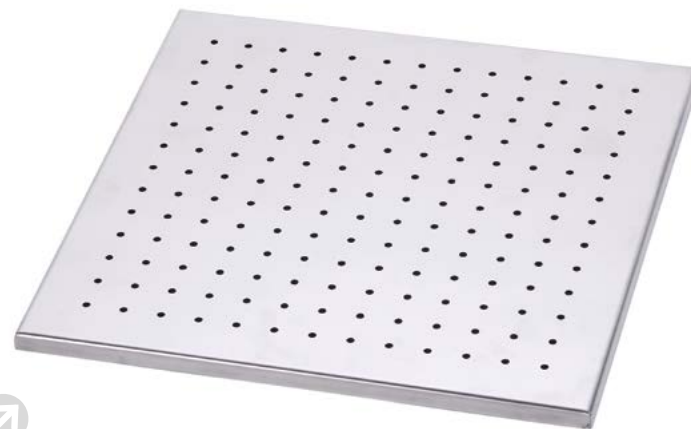



P/68002  
Soporte inox para 30 conos / Display for 30 cones  
Ø 2 cm  
50 x 15 x 8 cm



P/68009  
Soporte inox para 4 conos  
Display for 4 cones  
Ø 3 cm  
14 x 11 x 8 cm



P/68007  
Soporte inox para 1 cono  
Display for 1 cone  
Ø 3 cm  
7.5 x 6 x 8 cm



P/68008  
Soporte inox para 2 conos  
Display for 2 cones  
Ø 3 cm  
14 x 6 x 8 cm





## ¡Personalice! Customize!

Marcadores de latón, grabado con su logo o motivo. Marque y personalice alimentos, panes, carnes, pieles, frutas, soportes de madera como cajas, mini pallets de madera, palos de polos y todo lo que su fantasía sugiera. Resistente al fuego directo y al soplete.

Brass custom branding irons, engraved with your logo or design. Mark and personalize food, bread, meat, fish skin, fruit peels. Try them with wooden supports such as boxes, mini wooden pallets, ice cream sticks and anything your fantasy suggests. Resistant to direct fire and blowtorch.

### MARCADOR FUEGO FIRE MARKER

800/0008	3 x 3 cm
800/0009	4 x 4 cm
800/0010	5 x 5 cm
800/0011	6 x 6 cm
800/0012	7 x 5 cm
800/0013	8 x 5 cm
800/0014	Ø 4 cm
800/0015	Ø 6 cm



### MARCADOR DE HIELO ice marker

800/0022	3 x 3 cm
800/0023	4 x 4 cm
800/0024	5 x 5 cm
800/0025	Ø 2 cm
800/0026	Ø 3 cm
800/0027	Ø 4 cm

Más medidas disponibles bajo demanda  
More sizes available on demand





## BURGER MARKER - 230V 600W

800/0001	3 x 3 cm
800/0002	4 x 4 cm
800/0003	5 x 5 cm
800/0004	6 x 6 cm
800/0005	7 x 5 cm
800/0006	8 x 5 cm
800/0007	hasta / till Ø 6 cm

Personalice todo tipo de panes como el pan de hamburguesa, tortillas de maíz, pan de pita, panes rústicos, además de otros productos resistentes al calor como carnes o cajas de madera para presentaciones.

Customize all kinds of breads such as burger buns, corn tortillas, pita bread, rustic breads, as well as other heat-resistant products such as meat or wooden boxes.

\* Ask for other sizes

Marcador para personalizar con gran facilidad cubitos de hielo con el logo o el motivo que elija. Un toque de originalidad en sus servicios y eventos. Su grosor de 2 cm permite marcar varios cubitos a la vez. Funciona tan solo con la misma presión.

Pressure marker customize to easily ice cubes with your logo or motif. A touch of originality in your services and events. Its thickness of 2 cm allows you to mark several ice cubes at once. It works with just the pressure.



Acceso directo a las guías completas para personalizar sus marcadores  
Direct access to the complete guides to customise your favorite marker

**FREE EXTRA CONTENT**



## DISEÑE SU TAMPÓN DE SILICONA DESIGN YOUR OWN SILICONE SEAL

100/0181 4 x 3 cm

100/0182 6 x 4 cm

Cree su propio sello de silicona alimentaria con su diseño o logo. Estampe cualquier puré o tinta alimentaria. Pinte con cacao, mantequilla, grasa y espolvoree cualquier polvo cómo oro, plata o productos liofilizados.

Tampon carved in food silicone with your own design or logo. Print with any puree or food ink. Paint with cocoa, butter, fat and sprinkle any powder like gold, silver or freeze dried powders.



## GRABADOR ELÉCTRICO BRANDING CLAMP

Grabador diseñado para colocar palitos de polo de diversas formas y medidas, además de brochetas o pinzas. Todos los marcajes quedan en la misma posición. Regulable en temperatura, permite marcar madera, bambú, cuero y otros materiales.

Electric fire marker. Its base is designed to place ice-cream sticks of various sizes, skewers or tongs. All the marks are in the same position. Adjustable in temperature, it allows to mark wood, bamboo, leather and other materials.

100/0180  
Grabador personalizado eléctrico  
Custom Branding Clamp

230V

Max. 40 x 9 mm







MINI PRINT

100/0040



Cada caja contiene entre 2 y 3 unidades de la misma letra, incluye números..

Each box contains 2-3 pcs of the same letter, including numbers and signs.



## LOGO RELIEF

Grabe su logo en etiquetas, tapas de yogurt, cartas de menú, invitaciones, posavasos, papeles metálicos como aluminio, hojas de oro, cartón, papel...

Engrave your logo on labels, yogurt lids, menus, invitations, coasters, metallic papers such as aluminium, gold leaves, cardboard, paper...

Disponible en 3 formatos

Available in 3 sizes:

Ø 3.8 cm

Ø 4.8 cm

4.8 x 2.3 cm

100/0056  
Logo Relief



## SELLO LACRE WAX SEAL

800/0018    Ø 2 cm

800/0019    Ø 2.5 cm

800/0020    Ø 3 cm

800/0021    Ø 4 cm

Sellos personalizados para marcar a presión logos o pequeños motivos sobre chocolate, fondant, caramelo, gelatinas, mantequillas o deshidratados.

Custom wax seal stamps to mark logos or small motifs on chocolate, fondant, caramel, jelly, butters or dehydrated snacks.

It works with pressure.









Moulds  
¡Dale forma!  
Shape it!



# Krokanters

## Professional Stencil Collection

Plantillas de polipropileno para trabajar con productos espatulables sobre Teflón o silicona.

Elabore crujientes, snacks, guarniciones y decoraciones deshidratadas saladas y dulces.

Producto aprobado por expertos profesionales en cuanto a tamaño, grosor y redondeado de los ángulos.

Polypropylene stencils for working with spatulable products on Teflon or silicone.  
For making crunchy, sweet and savoury snacks, garnishes and dehydrated decorations.  
Product approved by professional experts in terms of size, thickness and rounded corners.



Opciones personalizables en nuestra página web

Customizable options on our website

**100%MAKEAT**

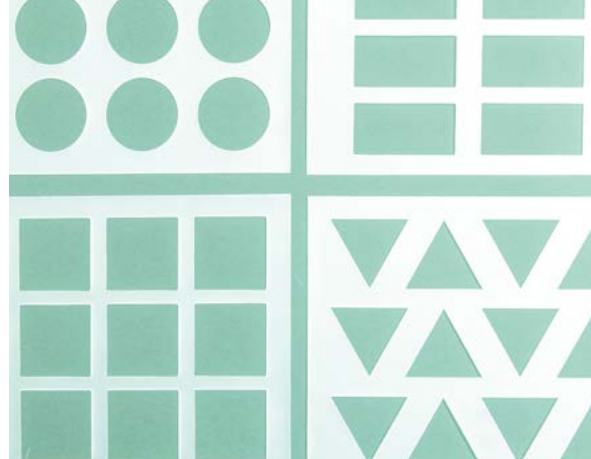

60/1001

Geometrik Kit



4.2 x 4.2 cm

18 uds pcs



3 x 6 cm

16 uds pcs

Pack

4 Plantillas diferentes Assorted Stencils



Ø 4.2 cm

18 uds pcs



4.5 x 4.5 cm

21 uds pcs



34 x 17 cm

60/1002

Naturaka Kit



7.5 x 6.5 cm

8 uds pcs



7 x 6 cm

8 uds pcs

Pack

4 Plantillas diferentes Assorted Stencils



9.8 x 2.8 cm

12 uds pcs



9.8 x 2.8 cm

12 uds pcs



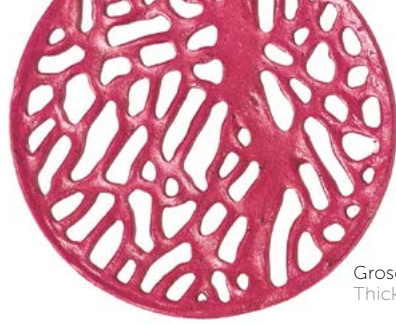

Grosor 2 mm  
Thickness 2 mm



MOLECULE



ALGAE



# Radikulados

## Professional Mould Collection

Moldes de silicona alimentaria para usar en pastelería, cocina y coctelería.

Indicados para la elaboración de crujientes snacks, guarniciones y decoraciones horneada, tanto saladas como dulces. Además, podrá elaborar blondas de azúcar o divertidos detalles con hielo coloreado de forma rápida y sencilla.

Foodgrade silicone moulds for use in pastry, cooking and cocktail making. Prepare crunchy snacks, garnishes and baked savory and sweet decorations. Make also your own sugar toppers and fun accents with colored ice.

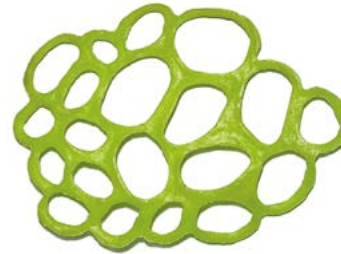

## Radikulados

60/1101	Molecule	60/1103	Snowflake
60/1102	Algae	60/1104	Lotus

40 x 10 x 0,4 cm - Depth 2 mm



Horno  
Oven safe



Lavavajillas  
Dishwasher safe



Congelación  
Frost resistant



SNOWFLAKE



LOTUS



Cómo usar Radikulados  
How to use Radikulados

100%MAKEAT



# Chokolade Forms

## Professional Mould Collection

Moldes termoformados reusables para chocolate y Petits Fours creativos. Fácil desmolde. Material apto para uso alimentario.

Re-usable thermoformed moulds for chocolate and creative Petits Fours. Easy demoulding. Food safe material.

### Chokolade Forms

60/1201	Diamond	60/1203	Bubbles
60/1202	BCN	60/1204	Bar



Congelación  
Frost resistant



Lavavajillas  
Dishwasher safe



Max temp. 60°C

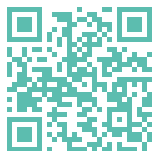

Opciones personalizables  
en nuestra página web

Customizable options  
on our website

**100%MAKEAT**

Tamaño de cada plantilla / Mould Sizes: 25 x 30 cm - 1 mm

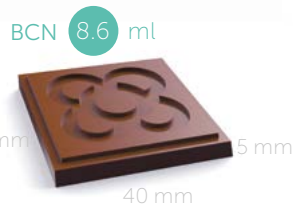
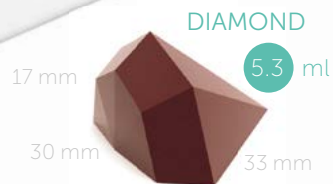

MAX 3D

# MimetikMould

Professional Creations

Piezas de silicona alimentaria extremadamente útiles en pastelería, cocina y coctelería. Disponibles en dos modelos:

- OLIVES, para elaborar aceitunas esferificadas gracias a la técnica del baño en manteca de cacao;
- SUPPORT, diseñado para almacenar, transportar, proteger o congelar piezas y decoraciones delicadas.

Foodgrade silicone pieces extremely useful in pastry, cooking and cocktail making. Available in two models:

- OLIVES, to make spherified olives thanks to the cocoa butter bath technique;
- SUPPORT, designed to store, transport, protect or freeze delicate pieces and decorations..



Encaja en las cubetas estándar  
It fits standard trays



Mimetik Mould

60/1301	Olives	16 x 14 cm
---------	--------	------------

60/1302	Support	25 x 19 cm
---------	---------	------------



Horno  
Oven safe



Lavavajillas  
Dishwasher safe



Congelación  
Frost resistant

TAKE CARE OF YOUR CREATIONS  
PROTEJA SUS CREACIONES DELICADAS





¡Reproduce cualquier forma!  
Recreate any shape!

# Oh! Mold

## Silicona líquida para moldes personalizados

Realice fácilmente moldes personalizados, sencillos o en 3D, con una altísima fidelidad al original. Reproduzca cualquier grabado, forma o volumen, recree verduras, frutas, legumbres, huesos, cubiertos, logos, etc. Inalterable al ácido, chocolate, grasas y alcoholes. Su flexibilidad permite realizar trabajos más precisos y delicados tanto en cocina, pastelería y cocktelería, además de un fácil desmoldeado. Color blanco puro. Inalterable y resistente, desde -25°C, hasta 220°C.

Certificación alimentaria CE y FDA.

## Liquid Silicone for Professional Mold Making

Foodgrade liquid mold making silicone to easily build simple or compound molds with high fidelity to the original. Produce soft and flexibles silicone molds for professional cook, pastry chef and bakery, etc. Produce any shape or carves, or hyperrealistic replicas of mini vegetables, fruits and legumes, cutlery, bones, logos, icecreams, creative ice cubes... Unalterable to acid, chocolate, fats, alcohol. White pure color. High elasticity (20SH) for perfect unmolding. Unalterable and resistant, from -25°C, up to 220°C.

Food grade certification FDA and CE.

EXTRA  
Soft · Blando  
20 SH

60/0016  
OH! MOLD  
Silicona líquida alimentaria  
Liquid Foodgrade silicone

1 kg



Instrucciones en  
User manual in:  
EN - SP - FR - IT



60/0019  
 Spray Antiadherente para  
 realizar moldes de silicona  
 Nonstick Spray for  
 silicone mold making



Horno  
Oven

Congelador  
Freezer

Microondas  
Microwave

Lavavajillas  
Dishwasher



Técnicas avanzadas de  
 moldeado personalizado  
 Advances techniques of  
 custom molding

**FREE EXTRA CONTENT**



FLEXIBLE  
 FLEXIBLE  
 RESISTENTE  
 DURABLE  
 PRECISO  
 PRECISE



# EASYMOULD

THE FIT MOULD COLLECTION

Easymould es el sistema más rápido y sencillo para moldear con láminas troqueladas de PET, listas para confeccionar piezas uniformes.

De fácil desmoldaje, perfecto acabado, multifuncional, limpio y de un solo uso.

Emplee Easymould en pastelería, catering o cocina. Prepare gelatina, mousses, tartars, helados, snacks, lollypops dulces o salados...

Easymould is a quick and easy moulding system with die-cut PET sheets. Ready to use and produce uniform pieces, formed in our specials trays.

Easy removal, perfect finish, multifunctional, clean. Designed for a single use. Ideal for the preparation of curds with gelatine, mousses, tartars, ice creams, snacks, sweet or savory lollypops.

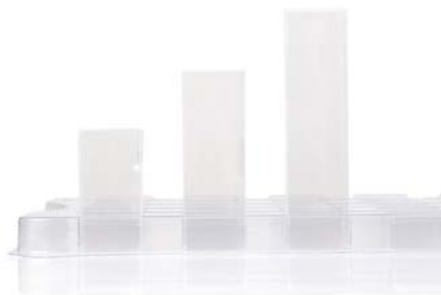

## Easymould

REDONDO / ROUND

100 uds  
pcs

60/0004 4 cm **S**

60/0005 6 cm **M**

60/0006 8 cm **L**

Ø 2.5 cm



## Easymould base

REDONDO / ROUND

60/0010 3 uds  
pcs

60/0011 24 uds **ECONOMIC**  
pcs **PACK**



Para 35 piezas / For 35 pcs x 3

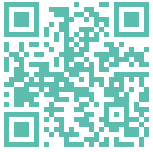

Cómo usar Easymould  
How to use Easymould

**FREE EXTRA CONTENT**



Easymould  
CUADRADO / SQUARE

100 uds  
pcs

60/0007 4 cm **S**

60/0008 6 cm **M**

60/0009 8 cm **L**

Base 2 x 2 cm

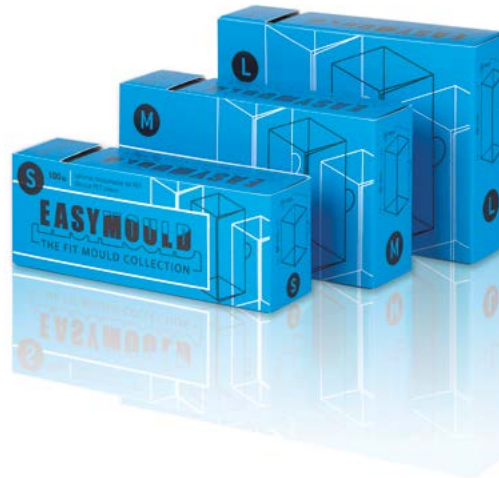

Easymould base  
CUADRADO / SQUARE

60/0012

3 uds  
pcs

60/0013

24 uds **ECONOMIC**  
pcs **PACK**



Para 35 piezas / For 35 pcs X 3



Perfectas esferas de hielo  
Perfect ice cube spheres

## IceBall Mould

Molde para esferas de hielo  
Spherical Ice Cube Mould



60/0003  
Ice Ball Mould

Fácil desmolde y gran producción.  
Easy removal, perfect finish and fast production!



## Square IceCube Mould

Molde para cubitos de hielo  
Square Ice Cube Mould

Crea las condiciones de congelación de lagos y ríos naturales, obteniendo cubitos de hielo transparente y descartando las impurezas en el fondo.

Es posible conseguir hasta tres formatos de hielo claro, brillante y transparente.

Square Ice Cube Mould imitates the natural process of lakes and rivers freezing, obtaining transparent ice cubes and discarding impurities at the bottom. You can obtain up to 3 different sizes of clear, shiny and transparent ice.

2 x 2 x 6 cm  
32 cubitos/cubes

4 x 4 x 4 cm  
8 cubitos/cubes

9 x 9 x 9 cm  
2 cubitos/cubes



60/0017  
IceCube Mould





3D

### Lipstick mould

Moldes fabricados en PET para formar piezas con mousses, purés de fruta, gelatinas o chocolate.

Moulds made in PET for moulding lipstick bars with fruit purees, jelly or chocolate.



60/0001  
Lipstick mould 3D



Lavavajillas hasta 70°C  
Dishwasher safe under 70°C



Resisten el congelado  
Frost resistant



60/0002  
Lollipop Mould 3D

### Lipstick tubes

100 uds  
pcs

100/0008

Transparente / Clear

100/0114

Plata / Silver



### Lollipop Palito Lollipop Stick

1000 uds  
pcs



10 cm

100/0124

Púrpura / Purple







Déjese inspirar por **YouCook**  
Get inspired by

YouCook es el canal de vídeo de 100%Chef, dedicado específicamente a profesionales y apasionados de la cocina creativa.

Nuevas tendencias, técnicas y secretos además de todos los consejos de uso sobre los productos desarrollados por 100%Chef.

YouCook is the video channel by 100%Chef, specifically addressed to food and beverage professionals and to vanguard cuisine lovers.

New trends, techniques and secrets revealed, in addition to all the tips and tricks to get the most out of our products.

**100%Chef**

[www.100x100chef.com](http://www.100x100chef.com)

**100%Barman**

[www.100x100barman.com](http://www.100x100barman.com)

**100%Lab**

[www.100x100lab.com](http://www.100x100lab.com)



[www.100x100ingredients.com](http://www.100x100ingredients.com)

Find us / Share your creations:



[orders@100x100chef.com](mailto:orders@100x100chef.com)



[100x100chef.com](https://www.instagram.com/100x100chef.com)

Cocina sin Límites, S.L.

Joan Peiró i Belis, 2 - Pol. Ind. Vallmorena  
08339 Vilassar de Dalt - Barcelona, Spain  
+ 34 93 429 63 40