



RESTAURANT
HOTEL

We strongly believe in the uniqueness of the single individual. We do not want a homogeneous world, where everyone thinks alike.
All we do is offer our customers the opportunity to stand out by becoming unique

We do all this starting from a family production tradition of over 70 years, made of craftsmanship of the highest quality and experience, combined with the most advanced technological solutions.

We produce unique and bespoke professional tools to suit your culinary art.

Since 1947

Crediamo fermamente nell'unicità del singolo individuo. Non vogliamo un mondo omogeneo, dove tutti pensano allo stesso modo.
Tutto quello che facciamo è offrire ai nostri clienti la possibilità di distinguersi, diventando unici.

Facciamo tutto questo partendo da una tradizione familiare produttiva di oltre 70 anni, fatta di artigianato ad altissima qualità ed esperienza, unito alle più avanzate soluzioni tecnologiche.

Produciamo articoli professionali unici e su misura, per soddisfare la vostra arte culinaria.

Mepra and
Pininfarina have
created STILE, a
refined collection
for the lovers of
Italian beauty.
We created a
s e p a r a t e d
catalog, only for
this collection.

STILE

by pininfarina

Dalla collabora-
zione di Mepra e
Pininfarina, nasce
STILE, una
c o l l e z i o n e
raffinata e
innovativa per gli
amanti della
bellezza italiana.
A b b i a m o
realizzato un
catalogo a parte,
solo per questa
collezione.

Icon of timeless beauty



Cisitalia, 1947: una scultura in movimento esposta permanentemente al MoMA di New York.

Cisitalia, 1947: a sculpture in movement Exposed at MoMA in New York.

The finishings
and the colors in
the following
pages, are
available for all
the flatware
models and for
the serveware.

Mepra Atelier

Le finiture ed i
colori presenti
nelle pagine
seguenti, sono
disponibili per
tutti i modelli di
posate e per tutto
il vasellame.





Mirror



O

Oro
Lucido



ON

Oro Nero
Lucido



B

Bronzo
Lucido



C

Champagne
Lucido



A

Arcobaleno
Lucido



AR

Argentato
Lucido



Ice



OI

ION

IB

IC

IA

ARI

Oro
Ice

Oro Nero
Ice

Bronzo
Ice

Champagne
Ice

Arcobaleno
Ice

Argentato
Ice



Peltro



PO

PON

PB

PC

PA

PAR

Oro
Peltro

Oro Nero
Peltro

Bronzo
Peltro

Champagne
Peltro

Arcobaleno
Peltro

Argentato
Peltro

MEPRA
S. p. A.
H & R DIVISION

Posate



FLATWARE COUVERTS BESTECKE CUBIERTOS

- Gamma completa per ogni modello
 - Spessore elevato
 - Rebbi delle forchette lavorati internamente
 - Seghettatura lame passante per un taglio perfetto
- Each collection consists of an extensive range of pieces.
- Thick stainless steel.
 - Fork tines are polished on all sides for a lifetime of performance.
 - Knife blades have a micro-serration for an effortless cut.
- Chaque modèle est complet de toute le pièces nécessaire
- Épaisseur massifs
 - Fourchons des fourchettes intérieurement travaillés
 - Les couteaux possèdent la dentelure fin ouvragée pour une coupe facile
- Jedes Modell verfügt über eine komplette Bandbreite an Zusatzteilen
- Hohe Materialstärke
 - Exakte, maschinell gefertigte Gabelzinken
 - Genauste Ausbildung der Messerschneiden für einen perfekteren Schnitt
- Cada modelo esta completo de todo lo necesario
- Espesor macizo
 - Tenedores con púas pulidas internamente.
 - Cuchillos con hoja sierra; corte perfecto

MEPRA
S.p.A.

























Mirror



| Code | mm. | inch. |
|--|-----|-------|
| 01  | 199 | 7 7/8 |
| 02  | 199 | 7 7/8 |
| 03  | 228 | 9 |
| 04  | 176 | 6 7/8 |
| 05  | 176 | 6 7/8 |
| 06  | 203 | 8 |
| 07  | 135 | 5 1/8 |
| 08  | 108 | 4 1/4 |
| 09  | 330 | 13 |
| 10  | 235 | 9 1/4 |
| 11  | 235 | 9 1/4 |
| 12  | 228 | 9 |
| 13  | 203 | 8 |
| 15  | 150 | 5 7/8 |
| 16  | 251 | 9 7/8 |
| 20  | 195 | 7 7/8 |
| 21  | 195 | 7 7/8 |
| 22  | 235 | 9 1/4 |
| 23  | 235 | 9 1/4 |
| 25  | 185 | 7 1/4 |
| 35  | 175 | 6 7/8 |
| 36  | 228 | 9 |
| 37  | 170 | 6 3/4 |
| 39  | 175 | 6 7/8 |
| 40  | 185 | 7 1/4 |
| 45  | 183 | 7 1/5 |

Coltelli disponibili anche con manico vuoto
 Hollow handle knives available
 Couteaux disponibles aussi avec un manche creux
 Messer in Hohlheft-Ausführung erhältlich
 Cuchillo disponible también en mango hueco



| Code | mm. | inch. |
|--|-----|-------|
| 01  | 201 | 7 7/8 |
| 02  | 201 | 7 7/8 |
| 03  | 230 | 9 |
| 04  | 180 | 7 |
| 05  | 177 | 7 |
| 06  | 202 | 8 |
| 07  | 139 | 5 1/2 |
| 08  | 110 | 4 1/3 |
| 09  | 304 | 12 |
| 10  | 243 | 9 5/8 |
| 11  | 243 | 9 5/8 |
| 15  | 145 | 5 3/4 |
| 16  | 243 | 9 5/8 |
| 20  | 210 | 8 1/4 |
| 21  | 192 | 7 1/2 |
| 22  | 243 | 9 1/2 |
| 23  | 243 | 9 1/2 |
| 25  | 201 | 8 |
| 35  | 180 | 7 |
| 36  | 227 | 9 |
| 37  | 164 | 6 1/2 |
| 39  | 180 | 7 |
| 40  | 175 | 6 7/8 |
| 45  | 203 | 8 |

Tutti i pezzi di questo modello sono realizzati in forgia
 All pieces in this range are forged
 Toutes les pièces de ce modèle sont forgées
 Alle Teile dieses Modells sind geschmiedet.
 Todas las piezas de este modelo son hechas en forgia

mm 9,0
ARIA



| Code | | mm. | inch. |
|------|--|-----|--------|
| 01 | | 208 | 8 1/5 |
| 02 | | 208 | 8 1/5 |
| 03 | | 235 | 9 1/4 |
| 04 | | 185 | 7 1/4 |
| 05 | | 185 | 7 1/4 |
| 06 | | 205 | 8 |
| 07 | | 140 | 5 1/2 |
| 08 | | 120 | 4 3/4 |
| 09 | | 275 | 10 3/5 |
| 10 | | 250 | 9 1/5 |
| 11 | | 250 | 9 1/5 |
| 15 | | 155 | 6 1/5 |
| 16 | | 260 | 10 1/4 |
| 20 | | 210 | 8 1/4 |
| 21 | | 185 | 7 1/4 |
| 22 | | 250 | 9 1/5 |
| 23 | | 250 | 9 1/5 |
| 25 | | 201 | 7 1/5 |
| 26 | | 156 | 6 1/2 |
| 35 | | 185 | 7 1/4 |
| 36 | | 235 | 9 1/4 |
| 37 | | 183 | 7 1/5 |
| 39 | | 185 | 7 1/4 |
| 40 | | 180 | 7 |
| 45 | | 183 | 7 1/4 |

I coltelli appoggiano sulla lama
 Knives may be set blade-down
 Les couteaux peuvent être posés debout sur leurs lames
 Durch das aussergewöhnliche Design, ist es möglich, die
 jeweiligen Messer auch hochkant, also "auf der Klinge
 stehend", abzustellen.
 Los cuchillos pueden apoyarse sobre la hoja.

Tutti i pezzi di questo modello sono realizzati in forgia
 All pieces in this range are forged
 Toutes les pièces de ce modèle sont forgées
 Alle Teile dieses Modells sind geschmiedet
 Todas las piezas de este modelo son hechas en forgia



| Code | mm. | inch. |
|------|-----|--------|
| 01 | 210 | 8 1/4 |
| 02 | 210 | 8 1/4 |
| 03 | 235 | 9 1/4 |
| 04 | 190 | 7 1/2 |
| 05 | 190 | 7 1/2 |
| 06 | 212 | 8 1/3 |
| 07 | 138 | 5 1/5 |
| 08 | 109 | 4 1/3 |
| 09 | 290 | 11 1/5 |
| 10 | 240 | 9 1/2 |
| 11 | 238 | 9 1/8 |
| 15 | 158 | 6 1/4 |
| 16 | 259 | 10 1/5 |
| 20 | 223 | 8 1/4 |
| 21 | 208 | 8 1/5 |
| 22 | 240 | 9 1/2 |
| 23 | 240 | 9 1/2 |
| 25 | 208 | 8 1/5 |
| 36 | 234 | 9 1/5 |
| 37 | 178 | 7 |
| 39 | 192 | 7 1/2 |
| 40 | 175 | 6 1/8 |

mm 4,0
ATENA



| Code | mm. | inch. |
|--|-----|--------|
| 01  | 200 | 7 7/8 |
| 02  | 202 | 8 |
| 03  | 221 | 8 3/4 |
| 04  | 180 | 7 |
| 05  | 180 | 7 |
| 06  | 198 | 7 3/4 |
| 07  | 135 | 5 1/3 |
| 08  | 114 | 4 1/2 |
| 09  | 312 | 12 1/8 |
| 10  | 235 | 9 1/4 |
| 11  | 240 | 9 1/2 |
| 15  | 150 | 5 7/8 |
| 16  | 255 | 10 |
| 20  | 210 | 8 1/4 |
| 21  | 202 | 8 |
| 22  | 235 | 9 1/4 |
| 23  | 235 | 9 1/4 |
| 25  | 185 | 7 1/4 |
| 31  | 114 | 4 1/2 |
| 35  | 180 | 7 |
| 36  | 221 | 8 3/4 |
| 37  | 162 | 6 1/5 |
| 39  | 180 | 7 |
| 40  | 185 | 7 1/4 |





| Code | | mm. | inch. |
|------|--|-----|--------|
| 01 | | 204 | 8 |
| 02 | | 204 | 8 |
| 03 | | 246 | 9 2/3 |
| 04 | | 175 | 6 7/8 |
| 05 | | 175 | 6 7/8 |
| 06 | | 220 | 8 2/3 |
| 07 | | 135 | 5 1/3 |
| 08 | | 111 | 4 1/8 |
| 09 | | 313 | 12 1/3 |
| 10 | | 253 | 10 |
| 11 | | 253 | 10 |
| 12 | | 245 | 9 2/3 |
| 13 | | 220 | 8 2/3 |
| 15 | | 154 | 6 |
| 16 | | 241 | 9 1/2 |
| 20 | | 207 | 8 1/7 |
| 21 | | 207 | 8 1/7 |
| 22 | | 253 | 10 |
| 23 | | 253 | 10 |
| 26 | | 164 | 6 1/2 |
| 35 | | 175 | 6 7/8 |
| 36 | | 245 | 9 2/3 |
| 37 | | 169 | 6 2/3 |
| 39 | | 175 | 6 7/8 |
| 40 | | 187 | 7 1/8 |
| 45 | | 192 | 7 1/2 |

Coltelli disponibili anche con manico vuoto
 Hollow handle knives available
 Couteaux disponibles aussi avec un manche creux
 Messer in Hohlheft-Ausführung erhältlich
 Cuchillo disponible también en mango hueco

mm 4,0
BAVARIA



| Code | | mm. | inch. |
|------|--|-----|--------|
| 01 | | 207 | 8 1/7 |
| 02 | | 207 | 8 1/7 |
| 03 | | 235 | 9 1/4 |
| 04 | | 180 | 7 |
| 05 | | 180 | 7 |
| 06 | | 204 | 8 |
| 07 | | 135 | 5 1/3 |
| 08 | | 114 | 4 1/2 |
| 09 | | 315 | 12 1/2 |
| 10 | | 250 | 9 1/8 |
| 11 | | 250 | 9 1/8 |
| 12 | | 235 | 9 1/4 |
| 13 | | 204 | 8 |
| 15 | | 155 | 6 |
| 16 | | 244 | 9 1/8 |
| 20 | | 180 | 7 |
| 21 | | 179 | 7 |
| 22 | | 250 | 9 1/8 |
| 23 | | 250 | 9 1/8 |
| 24 | | 140 | 5 1/2 |
| 25 | | 195 | 7 1/3 |
| 26 | | 155 | 6 1/3 |
| 35 | | 180 | 7 |
| 36 | | 224 | 8 1/5 |
| 37 | | 170 | 6 1/2 |
| 39 | | 180 | 7 |
| 40 | | 184 | 7 1/4 |
| 44 | | 165 | 6 1/2 |
| 45 | | 205 | 8 |

Coltelli disponibili anche con manico vuoto
 Hollow handle knives available
 Couteaux disponibles aussi avec un manche creux
 Messer in Hohlheft-Ausführung erhältlich
 Cuchillo disponible también en mango hueco

BOHEME mm 3,0



| Code | | mm. | inch. |
|------|--|-----|--------|
| 01 | | 204 | 8 |
| 02 | | 203 | 8 |
| 03 | | 232 | 9 1/8 |
| 04 | | 185 | 7 1/4 |
| 05 | | 184 | 7 1/4 |
| 06 | | 210 | 8 1/4 |
| 07 | | 134 | 5 1/4 |
| 08 | | 110 | 4 1/3 |
| 09 | | 288 | 11 1/3 |
| 10 | | 240 | 9 2/3 |
| 11 | | 241 | 9 1/2 |
| 15 | | 158 | 6 1/5 |
| 16 | | 258 | 10 |
| 20 | | 198 | 7 1/2 |
| 21 | | 184 | 7 1/4 |
| 25 | | 185 | 7 1/4 |
| 35 | | 182 | 7 1/5 |
| 36 | | 234 | 9 1/5 |
| 37 | | 172 | 6 3/4 |

mm 3,0
CARINZIA



| Code | | mm. | inch. |
|------|--|-----|-------|
| 01 | | 201 | 7 7/8 |
| 02 | | 201 | 7 7/8 |
| 03 | | 232 | 9 1/8 |
| 04 | | 170 | 6 2/3 |
| 05 | | 175 | 6 7/8 |
| 06 | | 199 | 7 7/8 |
| 07 | | 133 | 5 1/4 |
| 08 | | 110 | 4 1/3 |
| 10 | | 250 | 9 5/8 |
| 11 | | 255 | 10 |
| 15 | | 152 | 6 |
| 20 | | 210 | 8 1/4 |
| 21 | | 201 | 7 7/8 |
| 22 | | 250 | 9 5/8 |
| 23 | | 250 | 9 5/8 |
| 25 | | 195 | 7 2/3 |
| 26 | | 155 | 6 1/8 |
| 36 | | 224 | 8 2/3 |
| 37 | | 171 | 6 3/4 |
| 39 | | 170 | 6 2/3 |
| 45 | | 182 | 7 1/8 |



| Code | mm. | inch. |
|------|-----|--------|
| 01 | 206 | 8 1/5 |
| 02 | 206 | 8 1/5 |
| 03 | 240 | 9 4/5 |
| 04 | 178 | 7 |
| 05 | 178 | 7 |
| 06 | 214 | 8 4/5 |
| 07 | 133 | 5 1/4 |
| 08 | 113 | 4 4/5 |
| 09 | 315 | 12 3/5 |
| 10 | 245 | 9 2/3 |
| 11 | 245 | 9 2/3 |
| 12 | 240 | 9 4/5 |
| 13 | 214 | 8 4/5 |
| 15 | 155 | 6 |
| 16 | 241 | 9 1/2 |
| 20 | 210 | 8 3/4 |
| 21 | 206 | 8 1/5 |
| 22 | 240 | 9 4/5 |
| 23 | 244 | 9 2/5 |
| 25 | 208 | 8 1/6 |
| 26 | 156 | 6 1/7 |
| 35 | 178 | 7 |
| 36 | 240 | 8 4/5 |
| 37 | 169 | 6 2/3 |
| 39 | 178 | 7 |
| 40 | 183 | 7 1/5 |
| 45 | 177 | 7 |



PELTRO

Coltelli disponibili anche con manico vuoto
 Hollow handle knives available
 Couteaux disponibles aussi avec un manche creux
 Messer in Hohlheft-Ausführung erhältlich
 Cuchillo disponible también en mango hueco

mm 4,0 **DOLCE VITA**

| Code | mm. | inch. |
|------|-----|--------|
| 01 | 200 | 7 7/8 |
| 02 | 200 | 7 7/8 |
| 03 | 225 | 8 7/8 |
| 04 | 175 | 6 7/8 |
| 05 | 180 | 7 |
| 06 | 200 | 7 7/8 |
| 07 | 135 | 5 1/3 |
| 08 | 110 | 4 1/3 |
| 09 | 298 | 11 1/4 |
| 10 | 235 | 9 1/4 |
| 11 | 245 | 9 5/8 |
| 15 | 150 | 6 |
| 16 | 252 | 10 |
| 20 | 185 | 7 1/4 |
| 21 | 185 | 7 1/4 |
| 22 | 235 | 9 1/4 |
| 23 | 235 | 9 1/4 |
| 25 | 185 | 7 1/4 |
| 35 | 180 | 7 |
| 36 | 225 | 8 7/8 |
| 37 | 193 | 7 1/2 |
| 39 | 178 | 7 |
| 40 | 180 | 7 |
| 45 | 189 | 7 1/2 |



- ICE
- ORO ICE
- ORO NERO
- BRONZO
- CHAMPAGNE
- ARCOBALENO













| Code | | mm. | inch. |
|------|--|-----|--------|
| 01 | | 205 | 8 |
| 02 | | 206 | 8 1/8 |
| 03 | | 235 | 9 1/4 |
| 04 | | 175 | 6 7/8 |
| 05 | | 175 | 6 7/8 |
| 06 | | 202 | 8 |
| 07 | | 134 | 5 1/4 |
| 08 | | 111 | 4 1/3 |
| 09 | | 302 | 11 7/8 |
| 10 | | 231 | 9 |
| 11 | | 233 | 9 1/6 |
| 15 | | 157 | 6 1/6 |
| 16 | | 241 | 9 1/2 |
| 20 | | 184 | 7 1/4 |
| 21 | | 175 | 6 7/8 |
| 22 | | 231 | 9 |
| 23 | | 231 | 9 |
| 25 | | 195 | 7 1/3 |
| 36 | | 235 | 9 1/4 |
| 37 | | 175 | 6 7/8 |
| 39 | | 175 | 6 7/8 |
| 40 | | 173 | 6 1/3 |

mm 4,0

ELICA



| Code | mm. | inch. |
|------|-----|--------|
| 01 | 203 | 8 |
| 02 | 200 | 7 7/8 |
| 03 | 220 | 8 2/3 |
| 04 | 178 | 7 |
| 05 | 185 | 7 1/4 |
| 06 | 195 | 7 1/2 |
| 07 | 135 | 5 1/3 |
| 08 | 113 | 4 1/5 |
| 09 | 310 | 12 1/5 |
| 10 | 245 | 9 1/2 |
| 11 | 241 | 9 1/2 |
| 15 | 150 | 5 7/8 |
| 16 | 255 | 10 |
| 20 | 197 | 7 3/4 |
| 21 | 185 | 7 1/2 |
| 22 | 245 | 9 1/2 |
| 23 | 245 | 9 1/2 |
| 25 | 201 | 8 |
| 35 | 178 | 7 |
| 36 | 220 | 8 2/3 |
| 37 | 195 | 7 1/2 |
| 39 | 178 | 7 |
| 40 | 180 | 7 |

| Code | | mm. | inch. |
|------|---|-----|--------|
| 01 |  | 209 | 8 1/5 |
| 02 |  | 209 | 8 1/5 |
| 03 |  | 240 | 9 1/2 |
| 04 |  | 180 | 7 |
| 05 |  | 180 | 7 |
| 06 |  | 214 | 8 3/5 |
| 07 |  | 136 | 5 1/3 |
| 08 |  | 114 | 4 1/2 |
| 09 |  | 315 | 12 3/5 |
| 10 |  | 250 | 9 7/8 |
| 11 |  | 250 | 9 7/8 |
| 12 |  | 240 | 9 1/2 |
| 13 |  | 214 | 8 3/5 |
| 15 |  | 155 | 6 |
| 16 |  | 243 | 9 1/2 |
| 20 |  | 210 | 8 1/4 |
| 21 |  | 207 | 8 1/7 |
| 22 |  | 250 | 9 7/8 |
| 23 |  | 250 | 9 7/8 |
| 25 |  | 194 | 7 3/5 |
| 26 |  | 155 | 6 1/5 |
| 35 |  | 190 | 7 1/2 |
| 36 |  | 227 | 9 |
| 37 |  | 172 | 6 3/4 |
| 39 |  | 180 | 7 |
| 40 |  | 184 | 7 1/4 |
| 44 |  | 165 | 6 1/2 |
| 45 |  | 208 | 8 1/6 |



Coltelli disponibili anche con manico vuoto
 Hollow handle knives available
 Couteaux disponibles aussi avec un manche creux
 Messer in Hohlheft-Ausführung erhältlich
 Cuchillo disponible también en mango hueco

mm 4,0
EPOQUE



| Code | | mm. | inch. |
|------|--|-----|--------|
| 01 | | 205 | 8 |
| 02 | | 200 | 7 1/8 |
| 12 | | 215 | 8 1/2 |
| 04 | | 193 | 7 1/2 |
| 05 | | 178 | 7 |
| 13 | | 192 | 7 1/2 |
| 07 | | 138 | 5 1/2 |
| 09 | | 293 | 11 1/2 |
| 10 | | 249 | 9 1/2 |
| 11 | | 249 | 9 1/2 |
| 15 | | 172 | 6 1/4 |
| 16 | | 252 | 10 |
| 20 | | 211 | 8 1/3 |
| 21 | | 204 | 8 |
| 40 | | 201 | 7 1/2 |



Angelo Mangiarotti

Posata realizzata a manico vuoto.
 Hollow handle manufactured cutlery.
 Couvert réalisée avec les manches
 vides.
 Bestecke in Hohlheft-Ausführung
 verarbeitet.
 Cubierto hecha en mango hueco.

1322

ERGONOMICA





| Code | mm. | inch. |
|------|-----|--------|
| 01 | 210 | 8 1/4 |
| 02 | 210 | 8 1/4 |
| 03 | 234 | 9 1/5 |
| 04 | 190 | 7 1/2 |
| 05 | 187 | 7 1/3 |
| 06 | 208 | 8 1/5 |
| 07 | 142 | 5 1/5 |
| 08 | 120 | 4 3/4 |
| 09 | 300 | 11 1/2 |
| 10 | 255 | 10 |
| 11 | 250 | 9 1/6 |
| 15 | 160 | 6 1/3 |
| 16 | 280 | 11 |
| 20 | 212 | 8 1/3 |
| 21 | 186 | 7 1/3 |
| 22 | 255 | 10 |
| 23 | 255 | 10 |
| 25 | 195 | 7 1/3 |
| 35 | 188 | 7 1/5 |
| 36 | 234 | 9 1/5 |
| 37 | 198 | 7 1/5 |
| 39 | 190 | 7 1/2 |
| 40 | 191 | 7 1/2 |
| 45 | 193 | 7 1/5 |

I coltelli appoggiano sulla lama
 Knives may be set blade-down
 Les couteaux peuvent être posés debout sur leurs lames
 Durch das aussergewöhnliche Design, ist es möglich, die
 jeweiligen Messer auch hochkant, also "auf der Klinge
 stehend", abzustellen.
 Los cuchillos pueden apoyar sobre la hoja.

Tutti i pezzi di questo modello sono realizzati in forgia
 All pieces in this range are forged
 Toutes les pièces de ce modèle sont forgées
 Alle Teile dieses Modells sind geschmiedet
 Todas las piezas de este modelo son hechas en forgia

mm 5,0
FORMA

| Code | | mm. | inch. |
|------|---|-----|--------|
| 01 |  | 214 | 8 4/5 |
| 02 |  | 214 | 8 4/5 |
| 03 |  | 247 | 9 3/4 |
| 04 |  | 189 | 7 4/5 |
| 05 |  | 189 | 7 4/5 |
| 06 |  | 218 | 8 5/5 |
| 07 |  | 144 | 5 1/3 |
| 08 |  | 116 | 4 1/2 |
| 09 |  | 300 | 11 4/5 |
| 10 |  | 256 | 10 |
| 11 |  | 256 | 10 |
| 15 |  | 156 | 6 1/7 |
| 16 |  | 274 | 10 3/4 |
| 20 |  | 212 | 8 1/3 |
| 21 |  | 189 | 7 4/5 |
| 22 |  | 256 | 10 |
| 23 |  | 256 | 10 |
| 36 |  | 247 | 9 3/4 |
| 37 |  | 218 | 8 5/5 |
| 44 |  | 165 | 6 1/2 |



ADV
Astier de Villatte

12

GINEVRA mm 3,0



| Code | | mm. | inch. |
|------|--|-----|--------|
| 01 | | 195 | 7 7/8 |
| 02 | | 195 | 7 7/8 |
| 03 | | 218 | 8 5/8 |
| 04 | | 173 | 6 7/8 |
| 05 | | 173 | 6 7/8 |
| 06 | | 195 | 7 7/8 |
| 07 | | 130 | 5 1/8 |
| 08 | | 112 | 4 3/8 |
| 09 | | 299 | 11 3/4 |
| 10 | | 234 | 9 1/5 |
| 11 | | 234 | 9 1/5 |
| 15 | | 154 | 6 |
| 16 | | 251 | 9 7/8 |
| 20 | | 197 | 7 3/4 |
| 21 | | 195 | 7 7/8 |
| 22 | | 234 | 9 1/5 |
| 23 | | 234 | 9 1/5 |
| 25 | | 185 | 7 1/3 |
| 35 | | 175 | 6 7/8 |
| 36 | | 218 | 8 5/8 |
| 37 | | 153 | 6 |
| 39 | | 173 | 6 7/8 |
| 40 | | 184 | 7 1/4 |

mm 3,0
GOCCIA











| Code | mm. | inch. |
|------|-----|-------------------------------|
| 01 | 202 | 8 |
| 02 | 202 | 8 |
| 03 | 231 | 9 |
| 04 | 176 | 6 ² / ₉ |
| 05 | 176 | 6 ² / ₉ |
| 06 | 204 | 8 |
| 07 | 138 | 5 ¹ / ₅ |
| 08 | 106 | 4 ¹ / ₆ |
| 09 | 330 | 13 |
| 10 | 235 | 9 ¹ / ₄ |
| 11 | 235 | 9 ¹ / ₄ |
| 15 | 150 | 5 ⁷ / ₉ |
| 16 | 251 | 9 ⁷ / ₉ |
| 20 | 202 | 8 |
| 21 | 202 | 8 |
| 22 | 235 | 9 ¹ / ₄ |
| 23 | 235 | 9 ¹ / ₄ |
| 25 | 185 | 7 ¹ / ₄ |
| 36 | 210 | 8 ¹ / ₄ |
| 37 | 185 | 7 ¹ / ₄ |
| 39 | 182 | 7 ¹ / ₆ |
| 40 | 185 | 7 ¹ / ₄ |



| Code | | mm. | inch. |
|------|--|-----|--------|
| 01 | | 203 | 8 |
| 02 | | 203 | 8 |
| 03 | | 210 | 8 1/4 |
| 04 | | 177 | 7 |
| 05 | | 177 | 7 |
| 06 | | 190 | 7 1/2 |
| 07 | | 133 | 5 1/4 |
| 08 | | 113 | 4 1/5 |
| 09 | | 308 | 12 1/8 |
| 10 | | 237 | 9 1/3 |
| 11 | | 237 | 9 1/3 |
| 15 | | 157 | 6 1/6 |
| 16 | | 248 | 9 3/4 |
| 18 | | 241 | 9 1/2 |
| 20 | | 203 | 8 |
| 21 | | 203 | 8 |
| 22 | | 237 | 9 1/3 |
| 23 | | 237 | 9 1/3 |
| 24 | | 134 | 5 1/4 |
| 25 | | 185 | 7 1/4 |
| 35 | | 177 | 7 |
| 37 | | 177 | 7 |
| 39 | | 177 | 7 |
| 40 | | 187 | 7 1/3 |
| 45 | | 177 | 7 |



mm 3,0
ITALIA

| Code | | mm. | inch. |
|------|---|-----|-------|
| 01 |  | 207 | 8 1/5 |
| 02 |  | 201 | 7 7/8 |
| 03 |  | 219 | 8 3/5 |
| 04 |  | 178 | 7 |
| 07 |  | 134 | 5 1/4 |
| 08 |  | 120 | 4 3/4 |
| 15 |  | 135 | 5 1/3 |
| 21 |  | 210 | 8 1/4 |

Arch. Katja Bremkamp

The asymmetrical and rather unfamiliar shape of this cutlery range was influenced by the way we handle certain situations relating to the table routine. I was looking at the movements of the hands when dishing food out of bowls, when serving onto a plate and how this movement alters when food is conveyed into the mouth. Each piece reflects these movements individually, referring to their purposes and their "actions", as some pieces are more asymmetrical than others. The overall asymmetrical shape of this range therefore supports the comfortable handling of cutlery and also acts as guide to the person who is using it.

La forma asimmetrica e non convenzionale di questo modello è stata influenzata dall'osservazione dei comportamenti e delle routine legate al consumo del cibo a tavola. Ho guardato i movimenti delle mani durante la disposizione del cibo sul piatto, la raccolta del boccone e l'accompagnamento alla bocca. Ogni pezzo riflette individualmente questi movimenti, riferendosi al loro scopo e alle loro azioni; questo spiega il motivo per cui alcuni pezzi sono più asimmetrici di altri. Oltretutto, l'asimmetria di questa linea avvantaggia la maneggevolezza della posata in modo da guidare la persona che la usa.



ICE



| Code | mm. | inch. |
|------|-----|--------|
| 01 | 208 | 8 1/5 |
| 02 | 208 | 8 1/5 |
| 03 | 235 | 9 1/4 |
| 04 | 180 | 7 |
| 05 | 180 | 7 |
| 06 | 210 | 8 1/4 |
| 07 | 133 | 5 1/4 |
| 08 | 115 | 4 1/2 |
| 09 | 315 | 12 1/5 |
| 10 | 248 | 9 3/4 |
| 11 | 245 | 9 3/5 |
| 12 | 235 | 9 1/4 |
| 13 | 210 | 8 1/4 |
| 15 | 156 | 6 1/7 |
| 16 | 242 | 9 1/2 |
| 20 | 210 | 8 1/4 |
| 21 | 210 | 8 1/4 |
| 22 | 248 | 9 3/4 |
| 23 | 248 | 9 3/4 |
| 24 | 134 | 5 1/4 |
| 25 | 205 | 8 |
| 26 | 156 | 6 1/7 |
| 35 | 180 | 7 |
| 36 | 235 | 9 1/4 |
| 37 | 170 | 6 2/3 |
| 39 | 180 | 7 |
| 40 | 185 | 7 1/4 |
| 44 | 175 | 6 2/3 |
| 45 | 180 | 7 |

Coltelli disponibili anche con manico vuoto
 Hollow handle knives available
 Couteaux disponibles aussi avec un manche creux
 Messer in Hohlheft-Ausführung erhältlich
 Cuchillo disponible también en mango hueco

mm 4,0
LEONARDO



| Code | | mm. | inch. |
|------|--|-----|--------|
| 01 | | 205 | 8 |
| 02 | | 205 | 8 |
| 03 | | 233 | 9 1/6 |
| 04 | | 179 | 7 |
| 05 | | 179 | 7 |
| 06 | | 200 | 7 7/8 |
| 07 | | 135 | 5 1/3 |
| 08 | | 113 | 4 2/5 |
| 09 | | 316 | 12 2/5 |
| 10 | | 239 | 9 2/5 |
| 11 | | 245 | 9 2/3 |
| 15 | | 160 | 6 1/3 |
| 16 | | 244 | 9 2/5 |
| 20 | | 205 | 8 |
| 21 | | 208 | 8 1/5 |
| 22 | | 239 | 9 2/5 |
| 23 | | 239 | 9 2/5 |
| 25 | | 201 | 8 |
| 26 | | 158 | 6 1/5 |
| 35 | | 155 | 6 1/8 |
| 36 | | 233 | 9 1/6 |
| 37 | | 163 | 6 2/5 |
| 39 | | 179 | 7 |
| 40 | | 182 | 7 1/6 |
| 45 | | 179 | 7 |



Maurizio Duranti

30

LEVANTINA mm 3,5



| Code | | mm. | inch. |
|------|--|-----|-------|
| 01 | | 200 | 7 7/8 |
| 02 | | 203 | 8 |
| 03 | | 235 | 9 1/4 |
| 04 | | 178 | 7 |
| 05 | | 180 | 7 |
| 06 | | 205 | 8 |
| 07 | | 135 | 5 1/3 |
| 08 | | 115 | 4 1/2 |
| 09 | | 305 | 12 |
| 10 | | 245 | 9 2/3 |
| 11 | | 245 | 9 2/3 |
| 15 | | 150 | 6 |
| 16 | | 246 | 9 2/3 |
| 20 | | 200 | 7 7/8 |
| 21 | | 187 | 7 1/3 |
| 22 | | 245 | 9 2/3 |
| 23 | | 245 | 9 2/3 |
| 25 | | 185 | 7 1/3 |
| 35 | | 178 | 7 |
| 36 | | 235 | 9 1/4 |
| 37 | | 178 | 7 |
| 39 | | 178 | 7 |
| 40 | | 190 | 7 1/2 |

-  ICE
-  ORO
ICE
-  ORO
NERO
-  BRONZO
-  CHAMPAGNE
-  ARCOBALENO

mm 4,0
LINEA

Coltelli disponibili anche con manico vuoto
 Hollow handle knives available
 Couteaux disponibles aussi avec un manche creux
 Messer in Hohlheft-Ausführung erhältlich
 Cuchillo disponible también en mango hueco

| Code | mm. | inch. |
|------|-----|--------|
| 01 | 208 | 8 1/5 |
| 02 | 208 | 8 1/5 |
| 03 | 224 | 8 7/5 |
| 04 | 183 | 7 1/5 |
| 05 | 183 | 7 1/5 |
| 06 | 195 | 7 2/3 |
| 07 | 135 | 5 1/3 |
| 08 | 115 | 4 1/2 |
| 09 | 293 | 11 1/2 |
| 10 | 265 | 10 2/5 |
| 11 | 265 | 10 2/5 |
| 12 | 224 | 8 7/5 |
| 13 | 195 | 7 2/3 |
| 15 | 152 | 6 |
| 16 | 257 | 10 1/3 |
| 20 | 223 | 8 3/4 |
| 21 | 209 | 8 1/5 |
| 22 | 265 | 10 2/5 |
| 23 | 265 | 10 2/5 |
| 25 | 201 | 8 |
| 26 | 152 | 6 |
| 35 | 183 | 7 1/5 |
| 36 | 224 | 8 7/5 |
| 37 | 171 | 6 3/4 |
| 39 | 183 | 7 1/5 |
| 40 | 180 | 7 |



ICE



**Diciottesimo
 Premio Compasso d'Oro
 ADI**

Mediterranea
 Pisate
Maurizio Duranti
 Designer
Mepra spa
 Produttore

Selezione d'onore
 Compasso d'Oro
 ADI 1998

MEDITERRANEA mm 3,5



| Code | | mm. | inch. |
|------|--|-----|--------|
| 01 | | 209 | 8 1/5 |
| 02 | | 209 | 8 1/5 |
| 03 | | 235 | 9 1/4 |
| 04 | | 180 | 7 |
| 05 | | 180 | 7 |
| 06 | | 215 | 8 2/5 |
| 07 | | 136 | 5 1/5 |
| 08 | | 114 | 4 1/2 |
| 09 | | 315 | 12 1/5 |
| 10 | | 250 | 9 1/6 |
| 11 | | 250 | 9 1/6 |
| 12 | | 235 | 9 1/4 |
| 13 | | 204 | 8 |
| 15 | | 155 | 6 1/5 |
| 16 | | 243 | 9 1/2 |
| 18 | | 253 | 10 |
| 19 | | 251 | 9 1/5 |
| 20 | | 210 | 8 1/4 |
| 21 | | 207 | 8 1/7 |
| 22 | | 250 | 9 1/6 |
| 23 | | 250 | 9 1/6 |
| 24 | | 140 | 5 1/2 |
| 25 | | 195 | 7 1/5 |
| 26 | | 155 | 6 1/5 |
| 35 | | 190 | 7 1/2 |
| 36 | | 224 | 8 1/5 |
| 37 | | 170 | 6 2/5 |
| 39 | | 180 | 7 |
| 40 | | 184 | 7 1/4 |
| 44 | | 165 | 6 1/2 |
| 45 | | 208 | 8 1/6 |

Coltelli disponibili anche con manico vuoto
 Hollow handle knives available
 Couteaux disponibles aussi avec un manche creux
 Messer in Hohlheft-Ausführung erhältlich
 Cuchillo disponible también en mango hueco

mm 3,0

MICHELANGELO



| Code | | mm. | inch. |
|------|--|-----|--------|
| 01 | | 211 | 8 1/3 |
| 02 | | 211 | 8 1/3 |
| 03 | | 239 | 9 1/5 |
| 04 | | 181 | 7 1/6 |
| 05 | | 181 | 7 1/6 |
| 06 | | 215 | 8 1/5 |
| 07 | | 135 | 5 1/3 |
| 08 | | 114 | 4 1/2 |
| 09 | | 314 | 12 1/3 |
| 10 | | 250 | 9 1/6 |
| 11 | | 250 | 9 1/6 |
| 15 | | 158 | 6 1/5 |
| 16 | | 241 | 9 1/2 |
| 20 | | 213 | 8 1/5 |
| 21 | | 211 | 8 1/3 |
| 22 | | 250 | 9 1/6 |
| 23 | | 250 | 9 1/6 |
| 25 | | 201 | 8 |
| 26 | | 159 | 6 1/4 |
| 35 | | 189 | 7 1/5 |
| 36 | | 235 | 9 1/4 |
| 37 | | 174 | 6 1/8 |
| 39 | | 189 | 7 1/5 |
| 40 | | 190 | 7 1/2 |
| 45 | | 189 | 7 1/5 |
| 49 | | 149 | 5 1/8 |



| Code | mm. | inch. |
|--|-----|--------|
| 01  | 201 | 8 |
| 02  | 201 | 8 |
| 03  | 219 | 8 1/5 |
| 04  | 180 | 7 |
| 05  | 180 | 7 |
| 06  | 195 | 7 1/3 |
| 07  | 140 | 5 1/2 |
| 08  | 113 | 4 1/5 |
| 09  | 320 | 12 1/5 |
| 10  | 245 | 9 1/3 |
| 11  | 245 | 9 1/3 |
| 15  | 153 | 6 |
| 16  | 256 | 10 |
| 20  | 213 | 8 1/5 |
| 21  | 206 | 8 1/5 |
| 22  | 245 | 9 1/3 |
| 23  | 245 | 9 1/3 |
| 25  | 201 | 8 |
| 35  | 180 | 7 |
| 36  | 219 | 8 1/5 |
| 37  | 195 | 7 1/3 |
| 39  | 180 | 7 |
| 40  | 190 | 7 1/2 |

Giulio Iacchetti

mm 3,0 **MORGANA**



| Code | mm. | inch. |
|------|-----|--------|
| 01 | 200 | 7 7/8 |
| 02 | 204 | 8 |
| 03 | 230 | 9 |
| 04 | 180 | 7 |
| 05 | 180 | 7 |
| 06 | 204 | 8 |
| 07 | 135 | 5 1/3 |
| 08 | 113 | 4 2/5 |
| 09 | 310 | 12 1/5 |
| 10 | 240 | 9 1/2 |
| 11 | 245 | 9 2/3 |
| 15 | 150 | 5 2/3 |
| 16 | 252 | 10 |
| 20 | 222 | 8 3/4 |
| 21 | 203 | 8 |
| 22 | 240 | 9 1/2 |
| 23 | 240 | 9 1/2 |
| 25 | 201 | 8 |
| 35 | 180 | 7 |
| 36 | 230 | 9 |
| 37 | 204 | 8 |
| 39 | 180 | 7 |
| 40 | 180 | 7 |

I coltelli appoggiano sulla lama
 Knives may be set blade-down
 Les couteaux peuvent être posés debout sur
 leurs lames
 Durch das aussergewöhnliche Design, ist es
 möglich, die jeweiligen Messer auch hochkant,
 also "auf der Klinge stehend", abzustellen.
 Los cuchillos pueden apoyar sobre la hoja



| Code | | mm. | inch. |
|------|--|-----|--------|
| 01 | | 201 | 7 7/8 |
| 02 | | 201 | 7 7/8 |
| 03 | | 232 | 9 1/8 |
| 04 | | 170 | 6 2/3 |
| 05 | | 175 | 6 7/8 |
| 06 | | 199 | 7 7/8 |
| 07 | | 133 | 5 1/4 |
| 08 | | 110 | 4 1/3 |
| 09 | | 314 | 12 1/2 |
| 10 | | 250 | 9 7/8 |
| 11 | | 255 | 10 |
| 12 | | 232 | 9 1/8 |
| 13 | | 199 | 7 7/8 |
| 15 | | 152 | 6 |
| 16 | | 245 | 9 3/4 |
| 20 | | 170 | 6 2/3 |
| 21 | | 173 | 6 7/8 |
| 22 | | 250 | 9 7/8 |
| 23 | | 250 | 9 7/8 |
| 25 | | 195 | 7 3/4 |
| 26 | | 155 | 6 1/8 |
| 35 | | 175 | 6 7/8 |
| 36 | | 224 | 8 3/4 |
| 37 | | 171 | 6 3/4 |
| 39 | | 170 | 6 2/3 |
| 40 | | 190 | 7 1/2 |
| 45 | | 182 | 7 1/8 |

ICE

Coltelli disponibili anche con manico vuoto
 Hollow handle knives available
 Couteaux disponibles aussi avec un manche creux
 Messer in Hohlheft-Ausführung erhältlich
 Cuchillo disponible también en mango hueco

mm 4,0
NATURA



Coltelli disponibili anche con manico vuoto
 Hollow handle knives available
 Couteaux disponibles aussi avec un manche creux
 Messer in Hohlheft-Ausführung erhältlich
 Cuchillo disponible también en mango hueco

| Code | mm. | inch. |
|------|-----|--------------------------------|
| 01 | 205 | 8 |
| 02 | 205 | 8 |
| 03 | 230 | 9 |
| 04 | 175 | 6 ⁷ / ₈ |
| 05 | 175 | 6 ⁷ / ₈ |
| 06 | 203 | 8 |
| 07 | 133 | 5 ¹ / ₄ |
| 08 | 112 | 4 ¹ / ₅ |
| 09 | 310 | 12 ¹ / ₅ |
| 10 | 254 | 10 |
| 11 | 255 | 10 |
| 12 | 230 | 9 |
| 13 | 203 | 8 |
| 15 | 152 | 6 |
| 16 | 243 | 9 ⁵ / ₈ |
| 20 | 206 | 8 ¹ / ₈ |
| 21 | 206 | 8 ¹ / ₈ |
| 22 | 254 | 10 |
| 23 | 254 | 10 |
| 24 | 135 | 5 ¹ / ₈ |
| 25 | 195 | 7 ⁷ / ₈ |
| 26 | 160 | 6 ¹ / ₈ |
| 27 | 160 | 6 ¹ / ₈ |
| 28 | 180 | 7 |
| 35 | 175 | 6 ⁷ / ₈ |
| 36 | 233 | 9 ¹ / ₈ |
| 37 | 171 | 6 ³ / ₄ |
| 39 | 175 | 6 ⁷ / ₈ |
| 40 | 188 | 7 ³ / ₈ |
| 44 | 165 | 6 ¹ / ₂ |
| 45 | 175 | 6 ⁷ / ₈ |



| Code | | mm. | inch. |
|------|--|-----|--------|
| 01 | | 207 | 8 1/7 |
| 02 | | 207 | 8 1/7 |
| 03 | | 236 | 9 3/4 |
| 04 | | 179 | 7 |
| 05 | | 179 | 7 |
| 06 | | 213 | 8 3/5 |
| 07 | | 134 | 5 1/4 |
| 08 | | 113 | 4 3/5 |
| 09 | | 300 | 11 1/5 |
| 10 | | 248 | 9 3/4 |
| 11 | | 248 | 9 3/4 |
| 15 | | 155 | 6 1/8 |
| 16 | | 257 | 10 1/5 |
| 20 | | 179 | 7 |
| 21 | | 179 | 7 |
| 22 | | 248 | 9 3/4 |
| 23 | | 248 | 9 3/4 |
| 25 | | 195 | 7 7/5 |
| 26 | | 155 | 6 |
| 35 | | 175 | 6 3/5 |
| 36 | | 227 | 9 |
| 37 | | 172 | 6 3/4 |
| 39 | | 170 | 6 2/5 |
| 40 | | 180 | 7 |
| 45 | | 179 | 7 |

mm 4,0
PERLA



| Code | mm. | inch. |
|------|-----|--------|
| 01 | 209 | 8 1/5 |
| 02 | 209 | 8 1/5 |
| 03 | 235 | 9 1/4 |
| 04 | 180 | 7 |
| 05 | 180 | 7 |
| 06 | 204 | 8 |
| 07 | 136 | 5 1/3 |
| 08 | 114 | 4 1/2 |
| 09 | 315 | 12 1/5 |
| 10 | 250 | 9 7/8 |
| 11 | 250 | 9 7/8 |
| 12 | 235 | 9 1/4 |
| 13 | 204 | 8 |
| 15 | 155 | 6 |
| 16 | 243 | 9 1/2 |
| 20 | 210 | 8 1/4 |
| 21 | 207 | 8 1/7 |
| 22 | 250 | 9 7/8 |
| 23 | 250 | 9 7/8 |
| 25 | 195 | 7 2/3 |
| 26 | 155 | 6 1/8 |
| 35 | 190 | 7 1/2 |
| 36 | 235 | 9 1/4 |
| 37 | 170 | 6 2/3 |
| 39 | 180 | 7 |
| 40 | 184 | 7 1/4 |
| 44 | 165 | 6 1/2 |
| 45 | 180 | 7 |

Coltelli disponibili anche con manico vuoto
 Hollow handle knives available
 Couteaux disponibles aussi avec un manche creux
 Messer in Hohlheft-Ausführung erhältlich
 Cuchillo disponible también en mango hueco



| Code | mm. | inch. |
|------|-----|--------|
| 01 | 205 | 8 |
| 02 | 205 | 8 |
| 03 | 236 | 9 1/5 |
| 04 | 180 | 7 |
| 05 | 180 | 7 |
| 06 | 200 | 7 7/8 |
| 07 | 135 | 5 1/5 |
| 08 | 115 | 4 1/2 |
| 09 | 320 | 12 3/5 |
| 10 | 250 | 9 7/8 |
| 11 | 250 | 9 7/8 |
| 12 | 236 | 9 1/5 |
| 13 | 200 | 7 7/8 |
| 15 | 155 | 6 1/5 |
| 16 | 242 | 9 1/2 |
| 20 | 180 | 7 |
| 21 | 180 | 7 |
| 22 | 250 | 9 7/8 |
| 23 | 250 | 9 7/8 |
| 25 | 195 | 7 3/5 |
| 26 | 155 | 6 1/5 |
| 35 | 180 | 7 |
| 36 | 224 | 8 4/5 |
| 37 | 170 | 6 3/5 |
| 39 | 180 | 7 |
| 40 | 185 | 7 1/4 |
| 44 | 165 | 6 1/2 |
| 45 | 208 | 8 1/5 |

Coltelli disponibili anche con manico vuoto
 Hollow handle knives available
 Couteaux disponibles aussi avec un manche creux
 Messer in Hohlheft-Ausführung erhältlich
 Cuchillo disponible también en mango hueco

mm 4,0
ROMA



| Code | mm. | inch. |
|--|-----|--------|
| 01  | 204 | 8 |
| 02  | 204 | 8 |
| 03  | 239 | 9 2/5 |
| 04  | 175 | 6 7/8 |
| 05  | 175 | 6 7/8 |
| 06  | 203 | 8 |
| 07  | 133 | 5 1/4 |
| 08  | 109 | 4 1/3 |
| 09  | 313 | 12 1/3 |
| 10  | 232 | 9 1/8 |
| 11  | 232 | 9 1/8 |
| 12  | 239 | 9 2/5 |
| 13  | 203 | 8 |
| 15  | 156 | 6 1/7 |
| 16  | 244 | 9 2/5 |
| 18  | 242 | 9 1/2 |
| 19  | 240 | 9 2/5 |
| 20  | 206 | 8 1/8 |
| 21  | 203 | 8 |
| 22  | 232 | 9 1/8 |
| 23  | 232 | 9 1/8 |
| 24  | 134 | 5 1/4 |
| 25  | 207 | 8 1/7 |
| 26  | 159 | 6 1/4 |
| 35  | 190 | 7 1/2 |
| 36  | 239 | 9 2/5 |
| 37  | 180 | 7 |
| 39  | 175 | 6 7/8 |
| 40  | 188 | 7 2/5 |
| 45  | 208 | 8 1/5 |

Coltelli disponibili anche con manico vuoto
 Hollow handle knives available
 Couteaux disponibles aussi avec un manche creux
 Messer in Hohlheft-Ausführung erhältlich
 Cuchillo disponible también en mango hueco



| Code | | mm. | inch. |
|------|--|-----|--------|
| 01 | | 208 | 8 1/5 |
| 02 | | 208 | 8 1/5 |
| 03 | | 234 | 9 1/5 |
| 04 | | 185 | 7 1/4 |
| 05 | | 183 | 7 1/5 |
| 06 | | 208 | 8 1/5 |
| 07 | | 138 | 5 3/5 |
| 08 | | 109 | 4 1/3 |
| 09 | | 317 | 12 1/2 |
| 10 | | 240 | 9 1/2 |
| 11 | | 245 | 9 3/5 |
| 15 | | 157 | 6 1/5 |
| 16 | | 240 | 9 1/2 |
| 20 | | 182 | 7 1/6 |
| 21 | | 175 | 6 3/5 |
| 22 | | 240 | 9 1/2 |
| 23 | | 240 | 9 1/2 |
| 25 | | 185 | 7 1/4 |
| 40 | | 175 | 6 3/5 |

mm 4,0
SPARTA



| Code | | mm. | inch. |
|------|--|-----|--------|
| 01 | | 203 | 8 |
| 02 | | 202 | 8 |
| 03 | | 232 | 9 1/8 |
| 04 | | 181 | 7 1/8 |
| 05 | | 180 | 7 |
| 06 | | 204 | 8 |
| 07 | | 138 | 5 1/2 |
| 08 | | 115 | 4 1/2 |
| 09 | | 285 | 11 1/5 |
| 10 | | 246 | 9 2/3 |
| 11 | | 244 | 9 5/8 |
| 15 | | 151 | 6 |
| 16 | | 248 | 9 3/4 |
| 20 | | 200 | 7 7/8 |
| 21 | | 179 | 7 |
| 22 | | 245 | 9 2/3 |
| 23 | | 245 | 9 2/3 |
| 35 | | 178 | 7 |
| 36 | | 232 | 9 1/8 |
| 37 | | 178 | 7 |
| 39 | | 182 | 7 1/8 |
| 45 | | 184 | 7 1/4 |



| Code | | mm. | inch. |
|------|--|-----|--------|
| 01 | | 204 | 8 |
| 02 | | 201 | 7 7/8 |
| 03 | | 231 | 9 |
| 04 | | 184 | 7 1/4 |
| 05 | | 182 | 7 1/6 |
| 06 | | 209 | 8 1/5 |
| 07 | | 135 | 5 1/3 |
| 08 | | 110 | 4 1/3 |
| 09 | | 280 | 11 |
| 10 | | 231 | 9 |
| 11 | | 234 | 9 1/5 |
| 15 | | 153 | 6 |
| 16 | | 260 | 10 1/4 |
| 20 | | 197 | 7 3/4 |
| 21 | | 201 | 7 7/8 |
| 25 | | 185 | 7 1/3 |
| 35 | | 178 | 7 |
| 36 | | 230 | 9 |
| 37 | | 172 | 6 3/4 |

mm 3,0
STOCCOLMA

Giulio Iacchetti

| Code | | mm. | inch. |
|------|---|-----|--------|
| 01 |  | 200 | 7 7/8 |
| 02 |  | 200 | 7 7/8 |
| 03 |  | 211 | 8 1/3 |
| 04 |  | 177 | 7 |
| 05 |  | 177 | 7 |
| 06 |  | 189 | 7 1/2 |
| 07 |  | 135 | 5 1/3 |
| 08 |  | 112 | 4 2/5 |
| 09 |  | 295 | 11 3/5 |
| 10 |  | 240 | 9 1/2 |
| 11 |  | 240 | 9 1/2 |
| 13 |  | 189 | 7 1/2 |
| 15 |  | 150 | 5 7/8 |
| 16 |  | 256 | 10 |
| 20 |  | 215 | 8 1/2 |
| 21 |  | 199 | 7 7/8 |
| 22 |  | 240 | 9 1/2 |
| 23 |  | 240 | 9 1/2 |
| 25 |  | 201 | 8 |
| 37 |  | 189 | 7 1/2 |
| 39 |  | 177 | 7 |
| 40 |  | 183 | 7 1/5 |



Coltelli disponibili anche con manico vuoto
Hollow handle knives available
Couteaux disponibles aussi avec un manche creux
Messer in Hohlheft-Ausführung erhältlich
Cuchillo disponible también en mango hueco



www.mepura.it





I modelli delle due pagine seguenti, sono già disponibili in magazzino nella versione satinata, ICE. Tutti gli altri modelli possono essere forniti in versione ICE, a richiesta, senza quantità minima

The models on the two following pages are already available in stock in the satin ICE version. All the other models can be supplied on request in the ICE version, without minimum quantity.

Les modèles des deux pages suivantes sont déjà disponible en stock dans la version avec la surface de fin brossée, ICE. Tous les autres modèles peuvent être fournis en version ICE, sur demande, sans quantité minimum.

Die Modelle auf den folgenden zwei Seiten sind Ausführungen in der matte, gebürstete ICE Oberfläche auf Lager bereits. Alle anderen Modelle können auf Anfrage ohne Mindestmenge in der ICE-Version geliefert werden

Los modelos de las dos páginas siguientes sonya disponible en el almacén en la versión ICE, con la superficie satinada. Todos los otros modelos se pueden suministrar en la versión ICE, bajo pedido, sin cantidad mínima.

Ice



45 DUE ICE



41 ITALIA ICE



39 LEVANTINA ICE



47 LINEA ICE



57 GINEVRA ICE



42 NATURA ICE



40 MEDITERRANEA ICE



53 AVANGUARDIA ICE



Peltro





mm 3,0

70P CARINZIA PELTRO



mm 3,0

71P STOCCOLMA PELTRO



mm 4,0

69 EPOQUE PELTRO



mm 4,0

27 DOLCE VITA PELTRO

I modelli di queste pagine, sono già disponibili in magazzino nella versione antichizzata, PELTRO. Tutti gli altri modelli possono essere forniti in versione PELTRO, a richiesta, senza quantità minima

The models on this pages are already available in stock in the antiqued PELTRO version. All the other models can be supplied on request in the PELTRO version, without minimum quantity.







Oro



DESIGNPREIS
2009

NOMINEE

La speciale finitura non è ottenuta con metodi tradizionali come verniciatura o bagno galvanico, ma con un processo di impiantazione molecolare a base di titanio, frutto della ricerca aerospaziale.

Il prodotto è garantito per il lavaggio in lavastoviglie, non si macchia, non si ossida e resiste alla corrosione.

Unlike products that are coated or made with a galvanic process, our's is obtained using a titanium based molecular embedding process originally developed through aerospace research.

The product is dishwasher-safe, will not stain or oxidize and is highly resistant to corrosion.

Le produit n'est pas enduit ou fait avec un processus galvanique, Il est obtenu avec un processus à base de titane de d'implantation Moléculaire qui est le résultat de la recherche aérospatiale.

Le produit passe au lave-vaisselle, ne rouille pas ou ne s'oxyde pas et ne marque pas.

Die hier und vorher abgebildeten Bestecke, die mit einer Oberfläche aus Titan versehen sind, haben exakt die Farbe von Gold (ORO ICE), tiefem Schwarz (ORO NERO) und Bronze (BRONZO), was der Gestaltung von Tischen und Wohnräumen völlig neue Akzente verleiht. Das angewendete Veredelungsverfahren (P.V.D.) kommt aus der Raumfahrttechnik und war bisher bei der Gestaltung von Tabletop-Artikeln noch nie nicht angewendet worden bzw. völlig unbekannt.

Diese Produkte haben Dank des Titans eine 4 mal so harte Oberfläche wie Edelstahl, sehen nicht nur schön aus, sondern sind absolut robust und für den täglichen Gebrauch bestens geeignet.

Anfang des Jahres 2008 bekamen die Besteckmodell den begehrten Designpreis "Design Plus 2008" verliehen

El acabado especial no se obtiene de métodos tradicionales como barnizados o baño galvanico, se obtiene mediante un proceso de implantación molecular a base de titanio, fruto de la búsqueda aeroespacial.

El producto esta garantizado para el lavado en lava-vajillas, no se mancha, no se oxida y es resistente a la corrosión.



88 DUE ORO



89 LINEA ORO

I modelli di queste pagine, sono già disponibili in magazzino nella versione Oro. Tutti gli altri modelli possono essere forniti in versione Oro, a richiesta, senza quantità minima

The models on this pages are already available in stock in the Gold version. All the other models can be supplied on request in the Gold version, without minimum quantity.

Les modèles des cettés pages sont déjà disponible en stock dans la version Oro. Tous les autres modèles peuvent être fournis en version Oro, sur demande, sans quantité minimum.

Die Modelle auf diesei Seiten sind Ausführungen in der Oro, Oberfläche auf Lager bereits. Alle anderen Modelle können auf Anfrage ohne Mindestmenge in der Oro-Version geliefert werden

Los modelos de estas páginas son ya disponible en el almacén en la versión Oro. Todos los otros modelos se pueden suministrar en la versión Oro, bajo pedido, sin cantidad mínima.

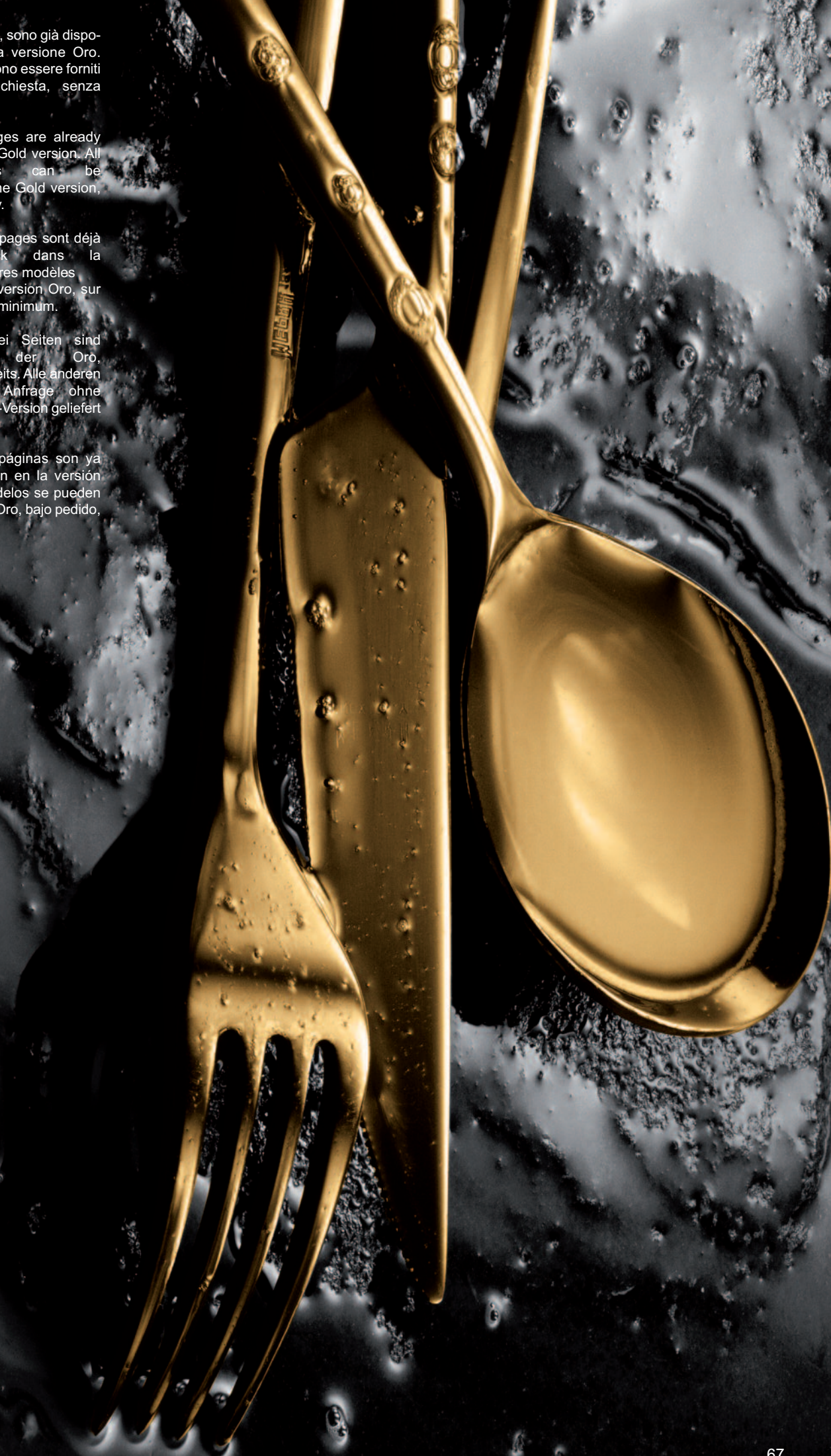



92 DUE CHAMPAGNE



86 DUE ORO NERO



93 LINEA CHAMPAGNE



87 LINEA ORO NERO



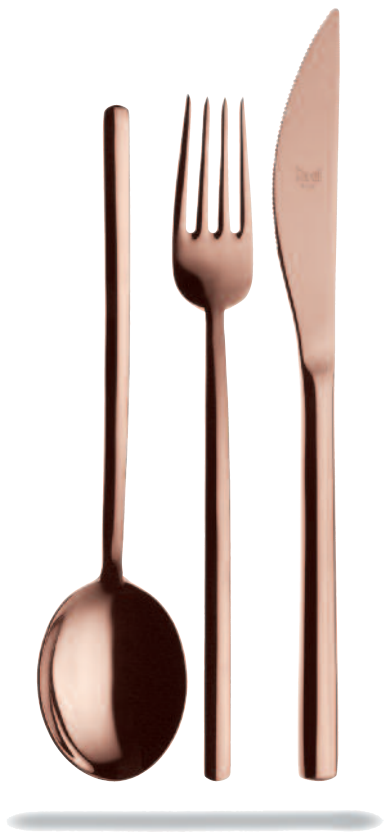

90 DUE BRONZO



80 DUE ICE ORO



91 LINEA BRONZO



81 LINEA ICE ORO





94 DUE ARCOBALENO



99 LINEA ARCOBALENO



Collezione



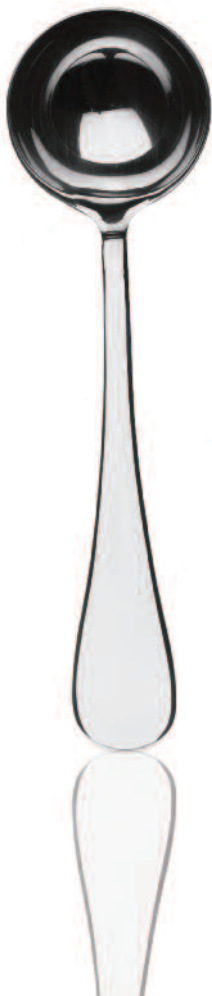

40

Mestolino per Salsa
Gravy ladle
Cuillère à sauce
Saucenöffel
Cacillo para salsaera

Si usa per servire
salse e condimenti
dalla salsiera
It is used to take sau-
ces and aromatic con-
diments from the gravy
boat.



16

Pala per Torta
Cake trowel
Pelle à tarte
Tortenheber
Pala tarta

Si usa per tagliare e
servire torte e semi-
freddi
It is used to portion
and serve cakes or
"semifreddi" (some
kinds of Italian ice-
cream).

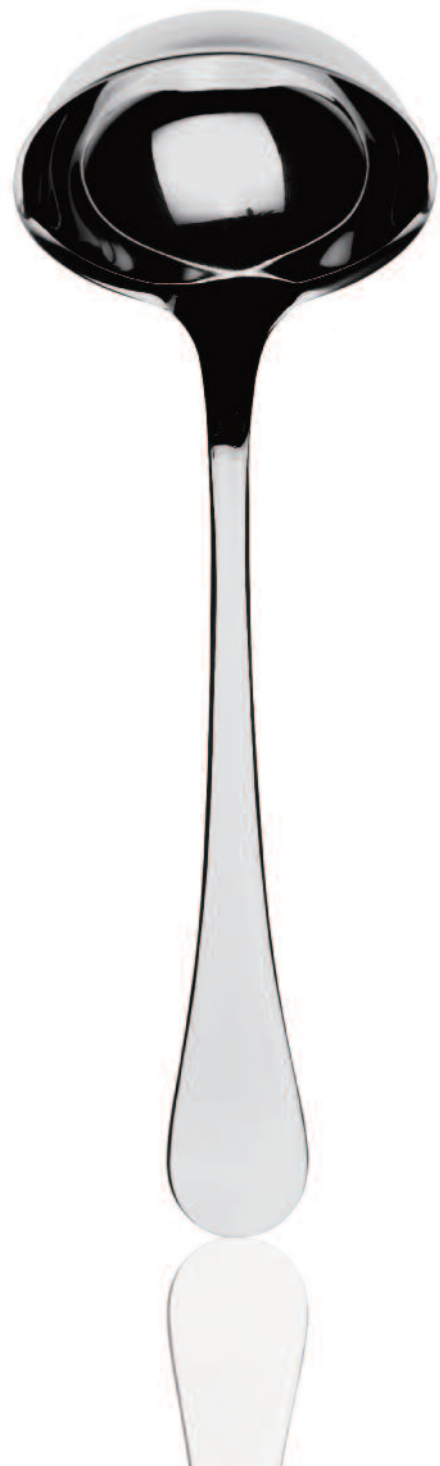

09

Mestolo a servire
Ladle
Louche
Suppenschöpfer
Cazo Sopa

Si usa per servire mine-
stre dalla zuppiera al
piatto fondo
It's used to serve soups
from the tureen to the
(soup) plate.



01

Cucchiaino Tavola
Table spoon
Cuillère table
Tafellöffel
Cuchara de mesa

Cucchiaino per minestre e primi piatti
Spoon for soups and first courses



04

Cucchiaino Frutta
Dessert spoon
Cuillère à dessert
Dessertlöffel
Cuchara postre

Cucchiaino per dessert a base di crema e salse. Molto utile anche per la prima colazione
Spoon for cream or sweet sauce desserts, very helpful for breakfast too.



07

Cucchiaino Caffè
Tea spoon
Cuillère à café
Kaffeelöffel
Cuchara café

In realtà è un cucchiaino per tè e tisane, utilizzato anche per le zuccheriere e le formaggere. Dato i molteplici utilizzi, è sempre meglio possederne una mezza dozzina in più rispetto al resto della pezzeria.
This is just a tea or herbal tea spoon, but is also used with sugar bowls and cheese basins. For this reason, it is better to have half of a dozen more than the rest of the cutlery.



08

Cucchiaino Moka
Coffee spoon
Cuillère à moka
Mokkalöffel
Cucharita moka

Cucchiaino per caffè
This is a coffee spoon



10

Cucchiaino a servire
Cooking spoon
Cuillère à legumes/ à ragût
Gemüselöffel
Cuchara legumbres

Si usa per servire sia primi piatti sia piatti principali. Buona regola possederne in quantità doppia rispetto al forchettone
It's used to serve first and main courses. It is better to have this cover twice than the cooking fork.



22

Cucchiaino Insalata
Salad serving spoon
Cuillère à salade servir
Salatvorlegelöffel
Cuchara servir ensalada

Si usa per mescolare e servire insalate, ma non solo: ottimo per servire antipasti a base di verdure e pesce. È usato per mix and serve salads, but is also very good to serve fish and vegetable hors-d'oeuvres.



23

25

44

39

45

35

26

Forchetta Insalata
Salad serving fork
Fourchette à salade servir
Salatvorlegegabel
Tenedor servir ensalada

Forchetta insalata
Si usa in coppia con
il cucchiaino insalata
Salad serving fork
It is used with the
salad spoon for serving.

Cucchiaino Bibita
Ice tea spoon
Cuillère à soda
Limonadenöffel
Cucharita refresco

Cucchiaino per
cocktail e gelati
con creme in
coppe profonde
Spoon used for
cocktails and
ice-creams served
in deep drinking-
glasses.

Cucchiaino Cappuccino
Cappuccino spoon
Cuillère à cappuccino
Cappuccinolöffel
Cucharita cappuccino

Cucchiaino per
cocktail e gelati
con creme in
coppe profonde
Spoon used for
cocktails and ice-
creams served in
deep drinking-
glasses.

Cucchiaino Gourmet
Gourmet spoon
Cuillère à degustation
Kostprobelöffel
Cuchara degustación

Cucchiaino per dolci
e pesce con salse.
La parte schiacciata
della tazza,
consente sia di tagliare
la pietanza,
che di raccoglierne
il sugo.
It's the spoon used
for cakes and fish
with sauce. The
crushed part of the
cup , allows both to
cut the course and
to collect the juice.

Cucchiaino Degustazione
French sauce spoon
Cuillère à sauce individuelle
Gourmetöffel
Cuchara salsa gourmet

Paletta per pesce
con salse, adatta a
tagliare il pezzo ed
a raccoglierne la
salsa.
Scoop for fish with
sauces , used to
cut the piece and
to reap the sauce .

Cucchiaino Zuppa
Soup spoon
Cuillère à soupe
Tassenlöffel rund
Cuchara para sopa

Cucchiaino per
consommé, tipica
forma di cucchiaino
per minestre in
brodo della tradizione
inglese.
It's the consommé
spoon used for the
traditionals English
soups.

Cucchiaino americano
American coffee spoon
Cuillère pour enfant
Kinderlöffel
Cucharita bebé

Cucchiaino per il
caffè americano. il
cappuccino, la
prima colazione,
oppure per dessert
a base di creme e
salse.
Spoon used for
american coffee,
cappuccino , breakfast
or for dessert with
cream and sauces .



02

Forchetta Tavola
Table fork
Fourchette table
Tafelgabel
Tenedor de mesa

Forchetta per primi piatti e piatto principale. Dato che è il pezzo in assoluto più utile ed usato, è sempre meglio possederne in doppia quantità rispetto agli altri pezzi.
Fork for first and main courses. It's better to have this cover twice, because it is the most useful one.



05

Forchetta Frutta
Dessert fork
Fourchette à dessert
Dessertgabel
Tenedor postre

Forchetta per antipasto e per dessert a base di frutta. Utilizzata per sbaglio spesso anche per i dessert a base dolce.
Hors d'oeuvre fork used for fruit desserts, it is wrongly used for sweet desserts.



15

Forchettina Dolce
Cake fork
Fourchette à gateaux
Kuchengabel
Tenedor pastel

Forchetta per tutti i dolci e dessert, tranne quelli a base di frutta.
Fork used only for cakes and sweet desserts, but not for fruit.



27

Forchettina Bebè
Baby fork
Fourchette pour enfant
Kindergabel
Tenedor bebè

Forchetta per bambini.
Fork for babies courses.



21

Forchetta Pesce da tavola
Table fish fork
Fourchette poisson table
Fischgabel
Tenedor pescado

Forchetta per pesce e molluschi
Fork for fishes and Mollusca



11

Forchettone a servire
Serving fork
Fourchette à légumes/ à servir
Fleischgabel
Tenedor legumbres

Si usa per servire sia primi piatti sia piatti principali.
It's used to serve first and main courses



03

Coltello Tavola
Table knife
Couteau table
Tafelmesser
Cuchillo de mesa

Coltello per piatto principale. Può essere in manico cavo, come le vecchie consigli in tavola in argento, leggero ed esclusivo; oppure in manico pieno prodotto con la tecnologia della forgiatura.
Table knife: Knife for main dishes with hollow handle, light and exclusive like the old fashioned silver covers or onepiece handle, made by the forging technology.



06

Coltello Frutta
Dessert knife
Couteau à dessert
Dessertmesser
Cuchillo postre

Coltello per antipasto e per dessert in combinazione con la forchetta frutta. Per qualità vale lo stesso discorso del coltello tavola
Used with the fruit fork in the hors-d'oeuvre and the fruit desserts. It's quality is the same of the table knife.



20

Paletta Pesce da tavola
Table fish knife
Couteau poisson table
Fischmesser
Cuchillo pescado

Coltello per tagliare pesce e molluschi
Knife used to slice fishes and Mollusca



28

Coltellino Bebè
Baby knife
Couteau pour enfant
Kindermesser
Cuchillo bebé

Coltellino per bambini.
Knife for babies courses.



36

Coltello Bistecca
Steak knife
Couteau à viande
Steakmesser
Cuchillo bistek

Coltello con lama profonda per bistecche di spessore.
Sharpedged blade knife helpful to cut substantial steaks



37

Coltello per burro
Butter knife
Couteau à beurre
Buttermesser
Cuchillo para mantequilla

Coltello per burro utilizzato per la prima colazione. Nella tradizione nordica ed inglese utilizzato sulla tavola in un piatto piano da frutta accanto al posto tavola, per spalmare il burro sul pane in occasione di lunch e dinner.
Butter cover used during breakfast. In England and in the North European countries during lunch or dinner it is put in a dish near the table set to spread butter on the bread.

Must Have

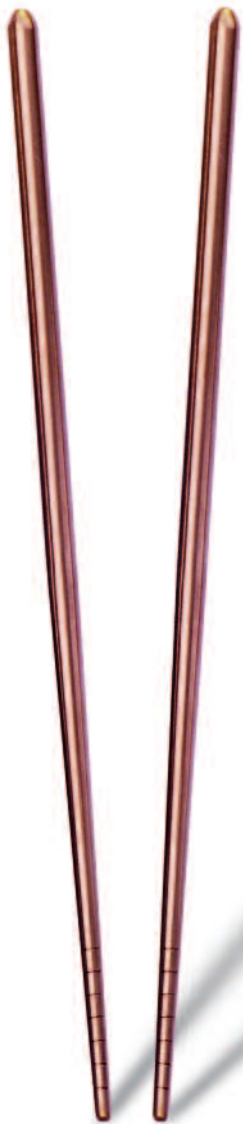

BRONZO
10001128B

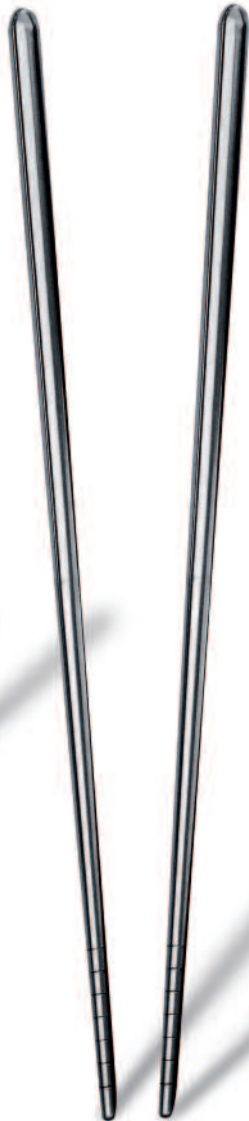

ACCIAIO
10001128



ORO NERO
10001128N



ORO
10001128O

ORO ICE
10001128OI



906
Appoggia chopstick
Chopstick rest
Porte chopstick
Ess-Stäbchen Ablage
Apoyo para chopstick

Largh. cm. 4,5
Width 1 3/4"

1128
Paia Chopsticks
Chopsticks set 2 pcs.
Paire de chopsticks
Ess-Stäbchen Paar
Chopsticks 2 pzas.

cm. 22,5
8 7/8"

CHOP STICKS





915
 Appoggia posate
 Knife rest
 Soutier p/couverts
 Besteck Ablage
 Apoyo p/cubiertos

Largh. cm. 6,5
 Width 2 1/2"



906
 Appoggia posate
 Knife rest
 Soutier p/couverts
 Besteck Ablage
 Apoyo p/cubiertos

Largh. cm. 4,5
 Width 1 3/4"



BRONZO
 10001175B



**ORO
 NERO**
 10001175ON



ACCIAIO
 10001175



ORO
 10001175O

ORO ICE
 10001175OI

1175
 Appoggia posate
 Knife rest
 Soutier p/couverts
 Besteck Ablage
 Apoyo p/cubiertos

Largh. cm. 6,5
 Width 2 1/2"

APPOGGIA POSATE





BRONZO
10001144B



ACCIAIO
10001144



ORO
NERO
10001144ON



ORO
10001144O
ORO ICE
10001144OI

1144
Coltello bistecca americano
American steak knife
Couteau entrecôte américain
Amerikanisches Steakmesser
Cuchillo bistek americano
cm. 25
9 5/8"

BISTECCA AMERICANO





UNI
10001136

Coltello bistecca
Steak knife
Couteau entrecôte
Steakmesser
Cuchillo bistek
cm. 21,3
8 1/4"

NORMA
10101136
BOHEME
10231136

Coltello bistecca
Steak knife
Couteau entrecôte
Steakmesser
Cuchillo bistek
cm. 23
9 1/8"

ROMA
10141136
1020B1136
NATURA
10341136

Coltello bistecca
Steak knife
Couteau entrecôte
Steakmesser
Cuchillo bistek
cm. 22,7
8 7/8"

10701136
CARINZIA

Coltello bistecca
Steak knife
Couteau entrecôte
Steakmesser
Cuchillo bistek
cm. 23,1
9 1/9"

10711136
STOCCOLMA

Coltello bistecca
Steak knife
Couteau entrecôte
Steakmesser
Cuchillo bistek
cm. 23,1
9 1/9"

BISTECCA





THE GOOD DESIGN AWARDS 2016

As Awarded by The Chicago Athenaeum:
Museum of Architecture and Design



JRE
JEUNES RESTAURATEURS



Ci sono Chef nel mondo che emozionano attraverso il gusto. Uno di questi è Ferran Adrià, cui omaggiamo l'idea della Quarta Posata, ispirata dalla sua pinza per tapas, oggi cambiata e migliorata per usi nuovi a tavola, insieme ai JRE Italia.

Cucchiaio, Forchetta, Coltello, Quarta Posata. Da oggi possiamo divertirci di più a tavola!



There are Chefs in the world who continuously create emotions through taste and do it better than us. One of these chefs is Ferran Adrià, who we honor with the idea of the Quarta Posata, inspired by his tapas tongs. Today, thanks to the collaboration with JRE Italy, is changed and improved for new uses on table: Spoon, Fork, Knife, Quarta Posata Starting today, we can have more fun on table!



QUARTA POSATA





10001129
Quarta posata

Lungh. cm. 22,2
Length 8 3/4"





BRONZO
10001139B



ACCIAIO
10001139



ORO
NERO
10001139N



ORO
10001139O
ORO ICE
10001139OI

1139
Forchetta aragosta
Lobster fork
Curette à homard
Hummergabel
Tenedor langostas

cm. 19,4
7 ²/₃"

ARAGOSTA



NEW

NEW



BRONZO
10341146B



ACCIAIO
10341146



ORO
NERO
10341146ON



ORO
10341146O
ORO ICE
10341146OI

1146
Cucchiaio multifunzione
Multifunctional spoon
Cuillère multifonctionnelle
Multifunktionaler Löffel
Cuchara multifuncional

cm. 17,6
6 3/8"

MULTIFUNZIONE



NEW

NEW



BRONZO
10101130B



ACCIAIO
10101130



ORO
NERO
10101130ON



ORO
10101130O

ORO ICE
10101130OI

1130
Amuse-bouche spoon

cm. 14,5
5 3/4"

AMUSE-BOUCHE



NEW

NEW



BRONZO
10001133B



ACCIAIO
10001133



ORO
NERO
10001133ON



ORO
10001133O
ORO ICE
10001133OI

1133
Cucchiaio per miele
Honey spoon
Cuillère à miel
Honiglöffel
Cuchara de miel

cm. 16
6 1/4"

MIELE





BRONZO
200727B



ORO
NERO
200727ON



ACCIAIO
200727



ORO
200727O

ORO ICE
200727OI

727
Coppa per intermezzo
Intermezzo cup
Coupe à intermezzo
Sorbetschale
Copa para intermezzo

cl. 4
oz. 1 ³/₈

INTERMEZZO



NEW

421

FASHION
Appoggia posate
Knife rest
Soutier p/couverts
Besteck Ablage
Apoyo p/cubiertos

cm. 12 x 8
4 3/4" x 3 1/7"

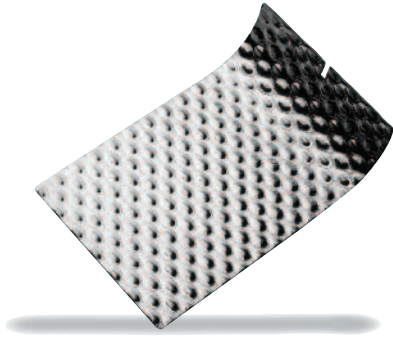

NEW

423

FASHION
Appoggia posate
Knife rest
Soutier p/couverts
Besteck Ablage
Apoyo p/cubiertos

cm. 11 x 3
4 1/3" x 1 1/5"



920

Appoggia posate
Knife rest
Soutier p/couverts
Besteck Ablage
Apoyo p/cubiertos

cm. 10 x 8
4" x 3 1/7"



NEW

424

GIOTTO
Appoggia posate
Knife rest
Soutier p/couverts
Besteck Ablage
Apoyo p/cubiertos

cm. 11 x 3
4 1/3" x 1 1/5"



740

Coppetta amouse bouche
Appetizer bowl
Bol multi-usages
Fingerfood-/Vorspeisen-/Butter-Gefäss
Cuenco para finger food/amouse bouche

cm. 13 x 7 - cl. 4
5 1/9" x 2 3/4" - oz. 4



10521131

Mini Forchetta
Appetizer fork
Fourchette amouse bouche
Minigabel
Mini tenedor

cm. 11,4
4 1/2"



10521108
Mini spoon

cm. 11,4
4 1/2"



750

Micro forchetta
Micro fork
Micro fourchette
Mikrogabel
Micro tenedor





ARAGOSTE



10001140

Pinza aragosta
Lobster pincers
Pince à homard
Hummerzange
Pinzalangostas
cm. 18,5
7 1/3"



10001139

Forchetta aragosta
Lobster fork
Fourchette langouste
Hummergabel
Tenedor langostas
cm. 19,4
7 2/3"



1020B1143

Cucchiaio risotto
"Risotto" spoon
Cuillère "Risotto"
Reisiöffel
Cuchara arroz seco
cm. 27,7
11"



10201144

Cucchiaino cappuccino
Cappuccino spoon
Cuillère cappuccino
Cappucinolöffel
Cucharita cappuccino
cm. 16,5
6 1/2"

Modelli-Models
POSATE

ANTIPASTI



10001150

Golf club mixer spoon
Golf club mixer spoon
Golf crosse pour cocktail
Golf Schleger für Long drink
Golf club cucharita por coctél
cm. 16,5
6 1/2"

LUMACHE



779

Molla lumache
Escargot tongs
Pince escargots
Schneckenzange
Pinzas caracoles
cm. 15,6
6 1/4"



10001138

Forchetta lumache
Escargot fork
Fourchette escargots
Schnecken-gabel
Tenedor caracoles
cm. 14,9
5 7/8"

FORMAGGIO



10001147

Forchetta formaggio
Cheese fork
Fourchette fromage
Käsegabel
Tenedor queso
cm. 21
8 3/8"



10001125

Coltello formaggio
Cheese knife
Couteau fromage
Kaesemesser
Cuchillo queso
cm. 22
8 3/4"



10001126

Coltello parmigiano
Parmesan chesse knife
Couteau parmesan
Parmesanmesser
Cuchillo parmigiano
cm. 16,5
6 1/2"



10001109



cm. 22
8 5/8"

mm. 3,0
Mestolo
Ladle
Louche
Suppschöpfer
Cazo sopa

10001142



cm. 20,7
8 1/8"

mm. 3,0
Cucchiaione
da risotto
Spoon for "Risotto"
Cuillère à "Risotti"
Reislöffel
Cuchara para arroz seco

10001110



cm. 17,5
6 3/4"

mm. 3,0
Cucchiaione
Serving spoon
Cuillère à servir
Servierlöffel
Cuchara servir

10001111



cm. 17
6 5/8"

mm. 3,0
Forchettone
Serving fork
Fourchette à servir
Serviergabel
Tenedor servir

10001122



cm. 17
6 5/8"

mm. 3,0
Cucchiaio insalata
Salad serving spoon
Cuillère à salade
Salatvorlegelöffel
Cuchara para ensalada

10001123



cm. 17
6 5/8"

mm. 3,0
Forchetta insalata
Salad serving fork
Fourchette à salade
Salatvorlegegabel
Tenedor para ensalada

10001116



cm. 18,5
7 1/4"

Pala per torta
Cake trowel
Pelle à tarte
Tortenheber
Pala tarta

10001115



cm. 10,5
4 1/4"

Forchettina dolce
Cake fork
Fourchette à gateaux
Kuchengabel
Tenedor pastel

10001120



cm. 15,5
6"

Paletta pesce tavola
Table fish knife
Couteau poisson
Fischmesser
Pala pescado

10001121



cm. 15,5
6"

Forchetta pesce tavola
Table fish fork
Fourchette poisson
Fischgabel
Tenedor pescado

10001141



cm. 12,5
4 7/8"

Happy spoon

10001127



cm. 10,5
4 1/4"

Cucchiaino bibita
Ice tea spoon
Cuillère à soda
Limonadenlöffel
Cucharita refresco

10001124



cm. 8,5
3 3/8"

Paletta gelato
Ice-cream spoon
Cuillère à glâce
Eislöffel
Cucharita helado

HAPPY



Fantasia



● Non ci si stanca mai del colore, soprattutto in ciò che ci circonda. Fantasia è un apostrofo funky tra le parole “Eleganza” e “Raffinatezza” di tutte le nostre collezioni. le posate sono realizzate in acciaio inossidabile 18/10 e da coloratissimi manici ad alta resistenza (hanno la stessa resistenza del legno, ma si possono lavare in lavastoviglie migliaia di volte).

● You never get tired of the color, especially in our surroundings. Fantasy is a funky apostrophe between the words "Elegance" and "Refinement" of all our collections. the cutlery are made of 18/10 stainless steel and highly coloured handles with high resistance (it has the same resistance of the wood, but it can be washed in the dishwasher thousands of times).

Fantasia è:

- Ultraresistente
- Lavabile in lavastoviglie
- Saldata ad ultrasuoni per una tenuta perfetta
- Acciaio inossidabile 18/10 ad elevato spessore
- Garantita a vita
- Ideale per:
- Pool & Pathio
- Spiagge
- Urban & Pop
- Ospedali
- Case di residenza per anziani
- Yacht
- Chalet
- Giardini
- Loft

Fantasia is:

- Ultra-resistant
- Dishwasher safe
- Ultrasonic welded for a perfect seal
- High thickness 18/10 Stainless steel
- Lifetime guaranteed
- Ideal for:
- Pool & Pathio
- Beaches
- Urban & Pop
- Hospitals
- Retirement homes
- Yacht
- Chalet
- Rooftop Gardens
- Loft





Mirror



O

ON

B

C

A

AR

Oro
Lucido

Oro Nero
Lucido

Bronzo
Lucido

Champagne
Lucido

Arcobaleno
Lucido

Argentato
Lucido



Ice



OI

Oro
Ice

ION

Oro Nero
Ice

IB

Bronzo
Ice

IC

Champagne
Ice

IA

Arcobaleno
Ice

ARI

Argentato
Ice



Peltro



PO

PON

PB

PC

PA

PAR

Oro
Peltro

Oro Nero
Peltro

Bronzo
Peltro

Champagne
Peltro

Arcobaleno
Peltro

Argentato
Peltro

COLORI DISPONIBILI



N
Nero
Black

I
Vigogna
Vicuna

W
Porcellana
China

M
Tabacco
Tobacco

S
Salvia
Sage

T
Tortora
Turte-dove

L
Vaniglia
Vanilla

D
Sesamo
Sesame

B7
Ciclamino
Light mauve

H7
Lilla
Lilac

P7
Rosa
Pink

Z7
Rosa pallido
Pale Rose

V
Verde
Green

A7
Mela verde
Apple Green

E
Verde acido
Acid Green

Q7
Verde oliva
Olive Green

AVAILABLE COLORS



PEZZI DISPONIBILI

10(color)1101

Cucchiaio tavola
Table spoon



Lunghezza 197 mm
Length 7 3/4"

10(color)1102

Forchetta tavola
Table fork



Lunghezza 197 mm
Length 7 3/4"

10(color)1103

Coltello tavola
Table knife



Lunghezza 223 mm
Length 8 3/4"

10(color)1104

Cucchiaio frutta
Dessert spoon



Lunghezza 174 mm
Length 6 7/8"

10(color)1105

Forchetta frutta
Dessert fork



Lunghezza 175 mm
Length 6 8/9"

10(color)1106

Coltello frutta
Dessert knife



Lunghezza 197 mm
Length 7 3/4"

10(color)1107

Cucchiaino caffè
Tea spoon



Lunghezza 133 mm
Length 5 1/4"

10(color)1115

Forchettina dolce
Cake fork



Lunghezza 157 mm
Length 6 1/5"

10(color)1126

Cucchiaino caffè americano
American size coffee spoon



Lunghezza 156 mm
Length 6 1/7"

10(color)1116

Pala per torta
Cake trowel



Lunghezza 254 mm
Length 10"

AVAILABLE RANGE

10(color)1122

Cucchiaio insalata a servire
Salad serving spoon



Lunghezza 233 mm
Length 9 1/6"

10(color)1123

Forchetta insalata a servire
Salad serving fork



Lunghezza 233 mm
Length 9 1/6"

10(color)1110

Cucchiaione
Serving spoon



Lunghezza 235 mm
Length 9 1/4"

10(color)1111

Forchettone
Carving fork

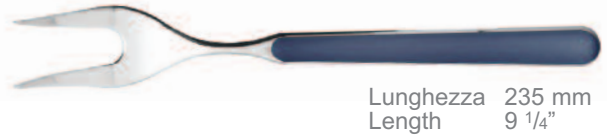

Lunghezza 235 mm
Length 9 1/4"

10(color)1140

Mestolino per salsiera
Gravy ladle



Lunghezza 185 mm
Length 7 1/4"

10(color)1120

Paletta pesce da tavola
Table fish knife

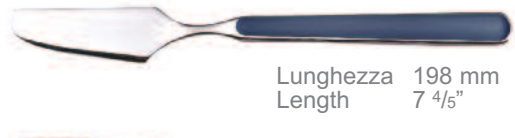

Lunghezza 198 mm
Length 7 4/5"

10(color)1121

Forchetta pesce da tavola
Table fish fork



Lunghezza 195 mm
Length 7 2/3"

10(color)1143

Cucchiaone da risotto
Rice spoon



Lunghezza 277 mm
Length 10 8/9"

10(color)1142

Forchetta per fonduta
Fondue fork



Lunghezza 290 mm
Length 11 2/5"

Vasellame



HOLLOWARE
MATERIEL DE SERVICE
ACCESSOIRES
ORFEBRERIA

- Gamma completa per tutti gli usi
- Spessore elevato
- Doppia saldatura manici, alta resistenza
- Beccucci rompigoccia
- Prodotti impilabili salvaspazio
- Criterio di progettazione di ogni prodotto accuratamente studiato per il quotidiano uso nel settore alberghiero.
- Each collection offers an extensive range of different items.
- Thicker stainless steel.
- Double welded handles offer durability.
- Drip-less spouts on all pitchers, creamers, coffee and tea pots.
- Space saving stackable items.
- Hospitality grade and professional quality

MEPRA
S.p.A.

- Gamme complète pour tous les us
- Épaisseur massives
- Soudures manches haute résistance
- Becs rompigoutes
- Articles empilables pour sauver space
- Critère de projet de chaque produit est étudié pour l'usage quotidien soigneusement dans le secteur hôtelier

- Ein vollständiges Sortiment für jeden Gebrauch
- Hohe Materialstärke
- Doppelt geschweisste
- Handgriffe, hohe Widerstandsfähigkeit
- Kein Tropfen beim Ausgießen
- Stapelbar und platzsparend
- Jedes Produkt ist genaustens für den täglichen
- Gebrauch in der Spitzengastronomie und -hotellerie gestaltet

- Gamma completa para todos los usos.
- Espesor macizo
- Mango soldado de alta resistencia.
- Vertedor rompe gotas
- Producto apilable ahorra espacio
- Criterio de diseño de cada producto estudiado minuciosamente para el uso cotidiano en el sector hostelero.

MEPRA
S.p.A.





Carbon Fiber

CARBON FIBER



14270

ANNIE

Vassoio in carbonio

Carbon fiber tray

Plateau en fibre de carbone

Kohlefaser-Tablett

Bandeja de fibra de carbono

cm. 72 x 50

28 1/3" x 19 3/4"





Atmosfera

La collezione ATMOSFERA è realizzata in acciaio inossidabile 18/10 con un trattamento di verniciatura in polvere. Oltre alla collezione ATMOSFERA, possiamo realizzare tutto il vasellame di questo catalogo nei tre colori:

The ATMOSFERA collection is made of 18/10 stainless steel with a powder coating treatment. In addition to the collection ATMOSFERA, we can make all the tableware of this catalog in the three colors:

La collection ATMOSFERA est réalisée en acier inoxydable 18/10 avec un traitement de revêtement de poudre. En plus de la collection ATMOSFERA, nous pouvons faire toute la vaisselle de ce catalogue dans les trois couleurs:

Die ATMOSFERA Kollektion besteht aus 18/10 Rostfreie Stahl mit einer Behandlung von pulverförmig. Zusätzlich der Kollektion können wir alle die Accessoires aus diesem Katalog in den drei Farben machen:

La colección ATMOSFERA está hecha de acero inoxidable 18/10 con un tratamiento de recubrimiento en polvo. Además de la colección ATMOSFERA, podemos realizar toda la orfebrería de este catálogo en los tres colores:



O
Materic Gold



N
Vulcan Grey



B
Materic Bronze

1016



mm. 1,2
MERCURIO
Cestino
Basket
Corbeille
Früchtekorb
Cesta

Ø cm. 11 Ø 4 3/8"
H cm. 12,5 H 4 7/8"
cl. 55 oz. 18 5/8

1017



mm. 1,2 Ø cm. 19
H cm. 20
Lt. 2,5

Ø cm. 29 Ø 7 1/2"
H cm. 18,5 H 7 3/4"
Lt. 8 oz. 84 1/2

669MG



mm. 1,2

Cestino
Basket
Corbeille
Früchtekorb
Cesta

Ø cm 14
H cm 13,5
lt. 0,70

Ø 5 2/3"
H 5 1/8"
oz. 23 2/3

668MG



mm. 1,2

Secchiello per spumante
Sparkling wine cooler
Seau à champagne
Wein- und Sektkühler
Cubo para champany

Ø cm 24
H cm 23
lt. 2,75

Ø 9 1/2"
H 9"
oz. 93

666FMG



mm. 1,2

Colonna portasecchiello
Wine cooler stand
Pied pour seau à champagne
Weinkühlerständer
Columna porta cubo champany

H cm. 65 H 25 5/8"



1011

1014



mm. 1,2

GIOVE
Cestino
Basket
Corbeille
Früchtekorb
Cesta

1011

cm. 16,6 x 10
H cm. 14,2
cl. 180

6 1/2" X 4"
H 5 3/5"
oz. 60 7/8

1014

cm. 27 x 20,5
H cm. 21,5
Lt. 6,5

10 5/8" X 8"
H 8 1/2"
gal. 1 3/4

1013

1012



mm. 1,2

MARTE
Cestino
Basket
Corbeille
Früchtekorb
Cesta

1013

Ø cm. 29
H cm. 18,5
Lt. 8

Ø 11 3/8"
H 7 1/4"
gal. 2

1012

Ø cm. 16,8
H cm. 11
cl. 150

Ø 6 5/8"
H 4 3/8"
oz. 50 3/4

666HMG

666CMG



mm. 1,2

Colonna portasecchiello spumante
Wine cooler stand
Pied pour seau à champagne
Weinkühlerständer
Columna porta cubo champany

H cm. 61,5

H 24 1/5"



mm. 1,2

Colonna portasecchiello spumante
Wine cooler stand
Pied pour seau à champagne
Weinkühlerständer
Columna porta cubo champany

H cm. 67,5

H 26 5/8"

1009

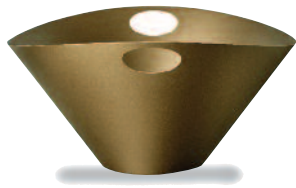

mm. 1,2

VENERE
Cestino
Basket
Corbeille
Früchtekorb
Cesta

cm. 22 x 20
H cm. 11,5
Lt. 1,2

8 5/8" x 7 7/8"
H 4 5/8"
oz. 40 1/2

1010



mm. 1,2

VENERE
Cestino
Basket
Corbeille
Früchtekorb
Cesta

cm. 39 x 36
H cm. 17,5
Lt. 7

15 3/8" x 14 1/4"
H 7"
gal. 1 4/5



1001



mm. 1,2 SATURNO
Piano
Tray
Plateau
Tablett oval
Bandeja
cm. 40 x 36 15 3/4" x 14 1/8"

1006



mm. 1,2 SATURNO
Piano
Tray
Plateau
Tablett oval
Bandeja
cm. 22 x 20 8 5/8" x 7 7/8"

1003



mm. 1,2 SATURNO
Piano
Tray
Plateau
Tablett oval
Bandeja
cm. 34 x 31 13 3/8" x 12 1/4"

1004



mm. 1,2 SATURNO
Piano
Tray
Plateau
Tablett oval
Bandeja
cm. 14 x 12 5 1/2" x 4 3/4"

1002



mm. 1,2 NETTUNO
Cestino
Basket
Corbeille
Früchtekorb
Cesta
100222
cm. 22 x 20
cl. 100
8 5/8" x 7 7/8"
OZ. 33 7/8
100240
cm. 40 x 36
cl. 200
15 3/4" x 14 1/8"
OZ. 67 5/8

1005

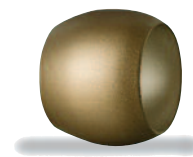

mm. 1,2 PLUTONE
Allacciatovaglioli
Napkins ring
Rond de serviette
Serviettenring
Servilletero
Ø cm. 6 Ø 2 3/8"



Sushic



787



787

TRE
Vassoio per prima colazione
Breakfast tray
Plateau rect. pour le petit déjeuner
Frühstück Tablett, rechteckig
Bandeja rect. por desayuno

cm. 50 x 32 27 1/2" x 12 5/8"

791AC



NEW

155



NEW

163



Inserto Finger Food per vassoio quadro e rettangolare
Finger Food insert for square and rectangular tray
Insért Finger Food pour plateau carré et rectangulaire
Finger Food-Einsatz für quadratische/rechteckig Schale
Inserto para Finger Food por bandeja cuadrada y rectangular
mm. 1,2

cm. 30 x 30

11 7/8" x 11 7/8"

Porta noccioli
Olive seeds jar
Porte noyaux
Aderhalter
Porta granos
mm. 1,2

Ø cm. 6

H cm. 5

cl. 5

Ø 2 2/5"

H 2"

oz. 1 3/4

TRE
Set per aperitivi
Appetizer set
Set pour Amouse bouche
Vorspeisen Set
Set para aperitivos

cm. 22 x 22
cl. 30

8 5/8" x 8 5/8"
oz. 10 1/8

793



TRE
Completo oliera con spargisale
Cruet and salt cellar set
Huile-vinaigre 4 pcs
Essig-/Öl-Menage 4-Tlg.
Vinagreras con saleros

cm. 15 x 15

H cm. 19,6

cl. 30 (x2)

cl. 8 (x2)

6" x 6"

H 7 3/4"

oz. 10 1/8 (x2)

oz. 2 3/4 (x2)

794



TRE
Formaggera
Parmesan cheese basin
Fromagère
Käsedose
Quesera Azucarero

cm. 15 x 15

cl. 20

6" x 6"

oz. 6 3/4

792



TRE
Vassoio rettangolare
Rectangular tray
Plateau rectangulaire
Tablett, rechteckig
Bandeja rectangular

cm. 50 x 32 19 3/4" X 12 3/4"
cm. 30 x 20 11 3/4" X 7 7/8"

788



QUATTRO
Vassoio rettangolare
Rectangular tray
Plateau rectangulaire
Tablett, rechteckig
Bandeja rectangular

cm. 50 x 32 19 3/4" X 12 3/4"
cm. 30 x 20 11 3/4" X 7 7/8"

791



TRE
Vassoio/Sottopiatto
Square Tray/Charger
Plateau/Assiette de bienvenue
Tablett/Platzteller,
Bandeja/Bajo plato

cm. 32 x 32 12 3/4" x 12 3/4"

789



QUATTRO
Vassoio/Sottopiatto
Square Tray/Charger
Plateau/Assiette de bienvenue
Tablett/Platzteller,
Bandeja/Bajo plato

cm. 32 x 32 12 3/4" x 12 3/4"

795



TRE
Tovaglietta americana
Place mat
Set de table
americain en bois
Tischset aus Holz
individual en madera

cm. 38 x 28 15" x 11"

796



TRE
Sottopiatto
Charger
Assiette de bienvenue
Platzteller
Bajo plato

Ø cm. 33 Ø 13"

804



TRE
Portacondimenti
Basket for aromatic condiments
Corbeille pour aromatiques condiments
Tisch-Essig/Öl-Flaschenhalter
Cesto para aromaticos y condimentos

cm. 15 x 15 6" x 6"
H cm. 19,6 H 7 3/4"

797



TRE
Cestino quadrato
Square basket
Corbeille carré
Schale, eckig
Panera cuadrada

cm. 15 x 15 6" x 6"
cm. 20 x 20 7 7/8" x 7 7/8"

599

58928

7 colori disponibili - pag. 312 - 313
7 colors available - pages 312 - 313
7 couleurs disponibles - pag. 312 - 313
7 verschiedenen Farben verfügbar - Seiten 312 - 313
7 colores disponibles - pag. 312 - 313

589 - Ø cm. 28
Ø 11"



mm. 1,2 UNO
Cestino traforato
Fretworked basket
Corbeille, ajourée
Früchtekorb gelocht
Cesta perforada

Ø cm. 29 Ø 11 3/8"
H cm. 18,5 H 7 1/4"
lt. 8 gal. 2

666B

Disponibile in color
Available in walnut
Disponible en couleur
In Wengè und Walnuss
Disponible en color

noce e wengè
and wengè color
noyer et wengè
Farbe verfügbar
nuez y wengè



TRE
Colonna portasecchiello
Wine cooler stand
Pied pour seau à champagne
Weinkühlerständer
Columna porta cubo champany

H cm. 65 H 25 5/8"



A Noce
Walnut
Noyer
Walnuss
Nuez

R Rovere
Oak
Chêne
Eiche
Roble

W Wengé





3504

3404

S7



S7



BARCELONA

J



J



Ø cm. 12,5

Ø 5"

cm. 14 x 14

5 1/2" x 5 1/2"

3503

3403

F7



F7



AMSTERDAM

N7



N7



Ø cm. 12,5

Ø 5"

cm. 14 x 14

5 1/2" x 5 1/2"

3505

3405

H7



H7



BERLIN

Q7



Q7

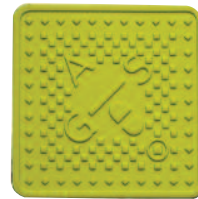

Ø cm. 12,5

Ø 5"

cm. 14 x 14

5 1/2" x 5 1/2"



3200

S7



3100
3600

S7



ROMA

S7

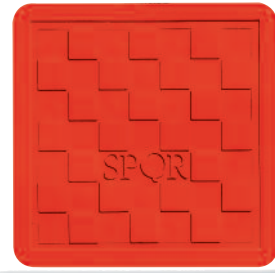

3300

J

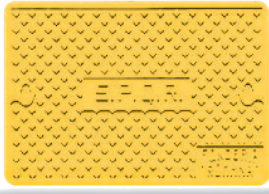

cm. 30 x 45

11 3/4" x 17 3/4"

3100
3600

J



3100 Ø cm. 17 Ø 6 3/4"
3600 Ø cm. 35 Ø 13 7/8"

J



cm. 45 x 45

17 3/4" x 17 3/4"

3202

F7



3102
3602

F7



LONDON

F7



3302

N7



3102 Ø cm. 17 Ø 6 3/4"
3602 Ø cm. 35 Ø 13 7/8"

N7



cm. 45 x 45

17 3/4" x 17 3/4"

3201

H7



3101
3601

H7



PARIS

H7



3301

Q7



cm. 30 x 45

11 3/4" x 17 3/4"

3101
3601

Q7



3101 Ø cm. 17 Ø 6 3/4"
3601 Ø cm. 35 Ø 13 7/8"

Q7



cm. 45 x 45

17 3/4" x 17 3/4"

Original Vintage





Gli articoli di queste pagine, sono già disponibili in magazzino nella versione antichizzata, PELTRO. Tutti gli altri articoli possono essere forniti in versione PELTRO, a richiesta, senza quantità minima

The items on these pages are already available in stock in the antiqued PELTRO version. All the other items can be supplied on request in the PELTRO version, without minimum quantity.

Les articles des cettas pages sont déjà disponible en stock dans la version avec la surface vieillie, PELTRO. Tous les autres articles peuvent être fournis en version PELTRO, sur demande, sans quantité minimum.

Die Artikeln auf diese Seiten sind Ausführungen in der antiken, Oberfläche PELTRO auf Lager bereits. Alle anderen Artikeln können auf Anfrage ohne Mindestmenge in der PELTRO-Version geliefert werden

Los artículos de estas páginas son ya disponibles en el almacén en la versión PELTRO, con la superficie envejecida. Todos los otros artículos se pueden suministrar en la versión PELTRO, bajo pedido, sin cantidad mínima.

187

186



Portauovo
Egg-cup
Coquetier
Eierbecher
Huevera
mm. 1,2

cm. 15 x 9
5 7/8" x 3 1/2"



Mini burriera
Mini Butter dish
Mini Beurrier
Mini Butterdose mit
Deckel
Mini Mantequera
mm. 1,2

cm. 12 x 6
cl. 15
4 3/4" x 2"
oz. 6

184

178



Salsiera
Gravy boat
Saucière
Sauciere
Salsera
mm. 1,2

cl. 30
oz. 10 1/8



Saucière
cl. 4
oz. 1 3/8
mm. 1,2

173

177



Piatto ovale da portata pesce
bordo rinforzato
Oval serving fish plate
with reinforced edges
Plat à poisson oval bord renforcé
Fischplatte, oval
Fuente pescado borde reforzado
mm. 1,2

cm. 55 x 24
cm. 70 x 29
21 5/8" x 9 1/2"
27 1/2" x 11 3/8"



Piatto ovale da portata
bordo rinforzato
Oval serving plate
with reinforced edges
Plat oval bord renforcé
Bratenplatte, oval
Fuente ovalada borde reforzado
mm. 1,2

cm. 30 x 21
cm. 40 x 27
cm. 50 x 35
11 3/4" x 8 1/4"
15 3/4" x 10 5/8"
27 1/2" x 11 3/8"

172



Vassoio rettangolare per
pasticceria
Rectangular tray for cakes
Plat à tarte rectangulaire
Gebäckplatte, rechteckig
Bandeja
mm. 0,6

cm. 26 x 19
cm. 31 x 21
10 1/4" x 7 1/2"
12 1/4" x 8 1/4"

182

174



Vassoio per gratin
Tray for "gratin"
Plat à "gratin"
Gratinplatte
Bandeja gratinar
mm. 1,2

cm. 35 x 20
cm. 40 x 24
13 3/4" x 7 1/8"
15 3/4" x 9 1/2"

181



Vassoio per gratin e gastronomia
Tray for "Gratin-gastronomy"
Plat à "Gratin et gastronomie"
Gratinplatte für Gastronomie
Bandeja para gratinar y gastronomia
mm. 1,2

cm. 30 x 22
cm. 40 x 29
11 3/4" x 8 5/8"
15 3/4" x 11 3/8"



Piatto rotondo da portata
bordo rinforzato
Round serving plate
with reinforced edges
Plat rond de service bord
renforcé
Bratenplatte, rund
Bandeja redonda borde
reforzado
mm. 1,2

Ø cm. 27
Ø cm. 35
Ø cm. 40
Ø 10 5/8"
Ø 13 3/4"
Ø 15 3/4"



171



Cestino semitraforato
Half fretworked basket
Corbeille demi-ajouré
Schale, halbgelocht
Frutero semiperforado

Ø cm. 22 Ø 8 5/8"
H cm. 5,7 H 2 1/4"
cl. 150 oz. 50 1/4

mm. 0,8

170



Cestino traforato
Fretworked basket
Corbeille ajouré
Schale, gelocht
Frutero perforado

Ø cm. 22 Ø 8 5/8"
H cm. 5,7 H 2 1/4"
cl. 150 oz. 50 1/4

mm. 0,8

880



Scodella lavadita
Finger bowl
Ecuelle
Fingerbowl
Lavadedos

Ø cm. 12 Ø 4 3/4"
cl. 30 oz. 10 1/8

mm. 0,6

175



Piatto tondo per legumi a 3 scompi.
3 sections vegetable dish
Plat à légumes rond - 3 compt.
Teller rund 3 Abteilungen
Bandeja para legumbres 3 comp.

Ø cm. 27 Ø 10 5/8"

mm. 0,8

176



Piatto ovale per legumi a 2 scompi.
2 section vegetable dish
Plat à légumes oval - 2 comp.
Teller oval, 2 Abteilungen
Bandeja para legumbres 2 comp.

cm. 30 x 21
11 3/4" x 8 1/4"

mm. 0,8

874



Sottopiatto
Charger
Assiette de bienvenue
Platzteller
Bajo plato

Ø cm. 33
Ø 13"

mm. 1,2

185



Ciotola con base
Bowl with base
Bol avec socle
Obstschale auf Fuss
Cuenco con pedestal
mm. 1,2

Ø cm. 14 - cl. 60 Ø 5 1/2" - oz. 20 1/2
H cm. 8,8 H 3 1/2"
Ø cm. 20 - lt. 1,8 Ø 7 7/8" - oz. 60 7/8
H cm. 11 H 4 1/2"
Ø cm. 24 - lt. 3,1 Ø 11" - oz. 104 7/8
H cm. 14 H 6 1/3"

882



Secchio per ghiaccio
Ice bucket with grill
Seau à glaçons
Eisgefäß
Cubitera hielo
mm. 1,2

Ø cm. 14 Ø 5 1/2"
H.cm.13 H 5 1/8"
cl. 150 oz. 50 3/4

884



Secchio per spumante
Sparkling wine cooler
Seau à champagne
Wein-und Sektkühler
Cubo para champany
mm. 1,2

Ø cm.23 Ø 9"
H cm.22,5 H 8 7/8"
lt. 8,5 gal. 2 1/4

188

180

881

179



Tegamino friggiuova
Frying pan for eggs
Plat à oeuf
Eierpfanne
Plato huevos

Ø cm. 16

Ø 6 1/4"

mm. 0,8

Coppa per gelato
Ice-cream bowl
Coupe à glace
Eisschale
Copa helado

Ø cm. 8,5
cl. 15

Ø 3 1/3"
oz. 5

mm. 0,6

Molla per arrosto e verdure
Roasts and vegetables tongs
Pince à salade et à rôti
Servierzange
Pinzas asado y verduras

cm. 21

8 1/4"

mm. 0,8

Molla per spaghetti
Spaghetti/Pasta tongs
Pince à spaghetti
Spaghettizange
Pinzas spaghetti

cm. 21

8 1/4"

mm. 0,6

87504

87508



mm. 1,2

Bricco
Jug
Cruche
Milchkanne
Jarra

Tazze 4 cl. 40
Cups 8 cl. 70
Bols
Tassen
Tazas

13 1/2 oz.
23 5/8 oz.

mm. 1,2

Bricco
Jug
Cruche
Milchkanne
Jarra

Tazze 4 cl. 40
Cups 8 cl. 70
Bols
Tassen
Tazas

13 1/2 oz.
23 5/8 oz.

879

878



mm. 1,2

Bricco
Jug
Cruche
Milchkanne
Jarra

Tazze 2 cl. 25
Cups
Bols
Tassen
Tazas

8 1/2 oz.

mm. 1,2

Zuccheriera
Sugar bowl
Sucrier
Zuckerdose
Azucarero

Tazze 8 cl. 30
Cups
Bols
Tassen
Tazas

10 1/8 oz.



Tendence

609



mm. 1,2
Piano
Tray
Plateau
Tablett oval
Bandeja

cm. 40 x 36 15 3/4" x 14 1/8"

612



mm. 1,2
Piano forato
Tray fretworked handles
Plateau avec anses ajourée
Grifftablett oval
Bandeja asa perforada

cm. 40 x 36 15 3/4" x 14 1/8"

613



mm. 1,2
Fondo
Bowl
Bol
Brotschale oval
Cuenco

cm. 22 x 20 8 5/8" x 7 7/8"
cl. 80 oz. 27

cm. 40 x 36 15 3/4" x 14 1/8"
lt. 4,0 gal. 1

614



mm. 1,2
Fondo forato
Bowl fretworked handles
Bol avec anses ajourée
Griffschale oval
Cuenco asa perforada

cm. 22 x 20 8 5/8" x 7 7/8"
cl. 49 oz. 16 1/2

cm. 40 x 36 15 3/4" x 14 1/8"
lt. 2,6 oz. 87 7/8

617



mm. 1,2
Sottopiatto ovale
Charger oval
Assiette de bienvenue ovale
Platzteller oval
Bajo plato oval

cm. 34 x 31 13 3/8" x 12 1/4"
cm. 39 x 36 15 3/8" x 14 1/8"

616AC



mm. 1,2
Piattino per pane
Bread tray
Plat pour pan
Brot Platte
Plato para pan

cm. 14 x 12 5 1/2" x 4 3/4"

561



mm. 1,2 Rettangolare piano
Rectangular tray
Plateau rectangulaire
Tablett, rechteckig
Bandeja rectangular

cm. 23 x 13 9" x 5 1/8"
cm. 38 x 25 15" x 9 7/8"

562



mm. 1,2 Rettangolare fondo
Rectangular bowl
Bol rectangulaire
Obstschale, rechteckig
Cuenco rectangular

cm. 38 x 25 15" x 9 7/8"
H cm. 5,1 H 2"
cl. 300 oz. 101 1/2

557



mm. 1,2 Ovale piano
Oval tray
Plateau, oval
Tablett, oval
Bandeja oval

cm. 37 x 25 14 1/2" x 9 7/8"
cm. 46 x 31 18 1/8" x 12 1/4"

558



mm. 1,2 Ovale fondo
Oval bowl
Bol oval
Obstschale, oval
Cuenco oval

cm. 37 x 25 14 1/2" x 9 7/8"
H cm. 6,3 H 2 1/2"
cl. 250 oz. 84 1/2
cm. 46 x 31 18 1/8" x 12 1/4"
H cm. 6,3 H 2 1/2"
cl. 400 gal. 1

563



mm. 1,2 Quadro piano
Square tray
Plateau carré
Tablett, quadratisch
Bandeja cuadrada

cm. 15 x 15 5 7/8" x 5 7/8"
cm. 22 x 22 8 5/8" x 8 5/8"

564

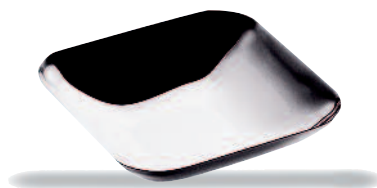

mm. 1,2 Quadro fondo
Square bowl
Bol carré
Schale, quadratisch
Cuenco cuadrado

cm. 15 x 15 5 7/8" x 5 7/8"
H cm. 4,9 H 2"
cl. 50 oz. 16 7/8
cm. 22 x 22 8 5/8" x 8 5/8"
H cm. 4,9 H 2"
cl. 150 oz. 50 3/4

559



mm. 1,2 Tondo piano Ø cm. 12 Ø 4 3/4"
 Wine bottle coaster
 Plateau ronde
 Tablett rund
 Bandeja redonda

560



mm. 1,2 Tondo fondo Ø cm. 12 cl. 26 Ø 4 3/4" oz. 8 3/4
 Round bowl H cm. 3,9 H 1 1/2"
 Bol ronde Ø cm. 15 cl. 60 Ø 5 7/8" oz. 20 1/4
 Obstschale, rund H cm. 5 H 2"
 Cuenco redondo Ø cm. 22 cl. 131 Ø 8 5/8" oz. 44 1/3
 H cm. 5,8 H 2 1/4"
 Ø cm. 32 lt. 3,0 Ø 12 5/8" oz. 101 2/5
 H cm. 6,8 H 2 2/3"

568

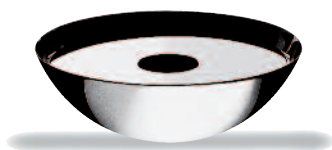

mm. 1,2 Posacenere ad acqua Ø cm. 12 Ø 4 3/4"
 Water ashtray cl. 26 oz 8 4/5
 Cendrier à eau
 Wasserасher rund
 Cenicerо ad agua

569



mm. 1,2 Posacenere ad acqua cm. 15 x 15 5 7/8" x 5 7/8"
 Water ashtray cl. 50 oz 16 7/8
 Cendrier à eau
 Wasserасher quadrat.
 Cenicerо ad agua

567



mm. 1,2 Sottopiatto cm. 32 x 32 12 5/8" x 12 5/8"
 Charger
 Assiette de bienvenue
 Platzteller
 Bajo plato

870

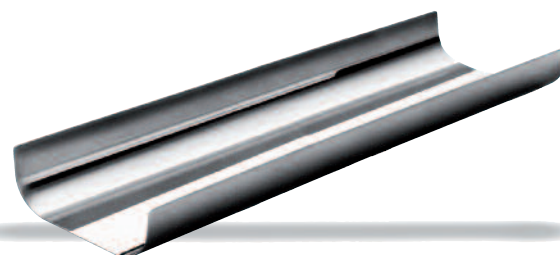

mm. 1,2 GIOTTO cm. 35,5 x 11 14" x 4 1/3"
 Portapanе / Portagrissini
 Bread / Bread sticks holder
 Porte pan / Porte gressini
 Brot und-Grissini -Schale
 Portapan / Porta bastoncillos de pan

596

599



608

mm. 1,2 Cestini traforati
Fretworked baskets
Corbeilles, ajourées
Früchtekorb gelocht
Cestas perforadas

596
Ø cm. 16,8 Ø 6 5/8"
H cm. 11 H 4 3/8"
cl. 150 oz. 50 3/4

608
Ø cm. 27 Ø 10 1/2"
H cm. 13,5 H 5 1/4"
lt. 5 gal. 1 1/3

599
Ø cm. 29 Ø 11 3/8"
H cm. 18,5 H 7 1/4"
lt. 8 gal. 2

730



mm. 1,2 Spumantiera 12 bottiglie champagne
Giant champagne bucket for 12 bottles
Seau à champagne géante pour 12 bouteilles
Champagner Bowl für 12 Flaschen
Cubo de champagne gigante para 12 botellas

cm. 75 x 65 29 1/2" x 25 5/8"
H cm. 19 H 7 1/2"
lt. 15 gal. 3 7/8

438

689

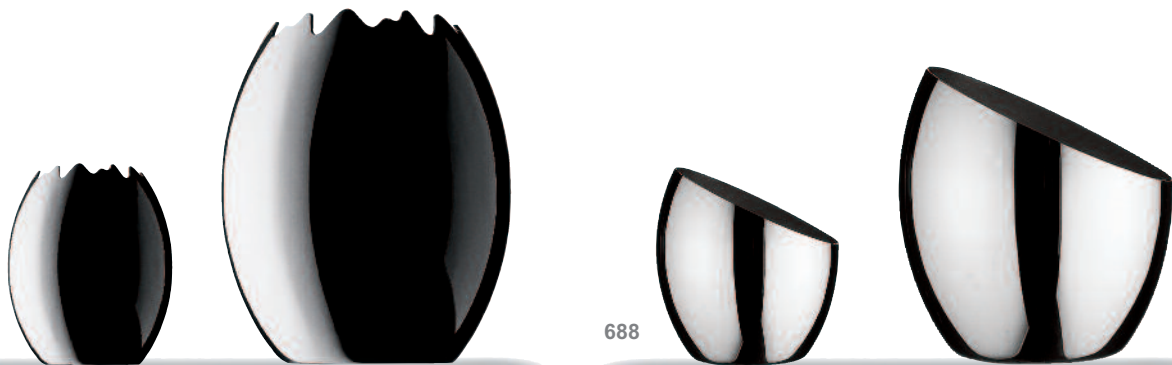

439

mm. 1,2
OVETTO
Secchiello per ghiaccio
Ice-bucket
Seau à glaçons
Eisgefäß
Cubitera hielo

Ø cm. 11
H cm. 13
cl. 100
Ø 4 3/8"
H 5 1/8"
oz. 33 7/8

mm. 1,2
OVO
Secchiello per spumante
Sparkling wine cooler
Seau à champagne
Wein- und Sektkühler
Cubo para champany

Ø cm. 19
H cm. 22
lt. 4,5
Ø 7 1/2"
H 8 5/8"
gal. 1 1/4

688

mm. 1,2
Secchiello per ghiaccio
Ice-bucket
Seau à glaçons
Eisgefäß
Cubitera hielo

Ø cm. 11
H cm. 12,5
cl. 55
Ø 4 3/8"
H 4 7/8"
oz. 18 5/8

mm. 1,2
Secchiello per spumante
Sparkling wine cooler
Seau à champagne
Wein- und Sektkühler
Cubo para champany

Ø cm. 19
H cm. 20
lt. 2,5
Ø 7 1/2"
H 7 3/4"
oz. 84 1/2

598



607



597

mm. 1,2
Cestini
Baskets
Corbeilles
Früchtekorben
Cestas

598
Ø cm. 29 Ø 11 3/8"
H cm. 18,5 H 7 1/4"
lt. 8 gal. 2

607
Ø cm. 27 Ø 10 1/2"
H cm. 13,5 H 5 1/4"
lt. 5 gal. 1 1/3

597
Ø cm. 16,8 Ø 6 5/8"
H cm. 11 H 4 3/8"
cl. 150 oz. 50 3/4

666C

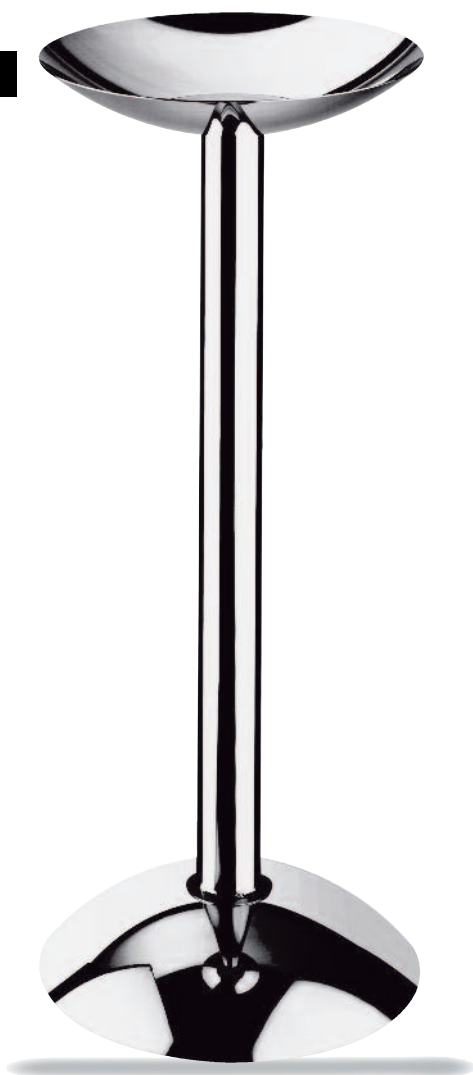

mm. 1,2 UNO
Colonna portasecchiello spumante
Wine cooler stand
Pied pour seu à champagne
Weinkühlerständer
Columna porta cubo champany

H cm. 65 H 25 5/8"

912



909

mm. 1,2
Secchiello per spumante
Sparkling wine cooler
Seau à champagne
Wein- und Sektkühler
Cubo para champany

cm. 39 x 36
H cm. 17,5
lt. 6
15 3/8" x 14 1/4"
H 7"
gal. 1 3/5

mm. 1,2
Secchiello per ghiaccio
Ice-bucket
Seau à glaçons
Eisgefäß
Cubitera hielo

cm. 22 x 20
H cm. 11,5
lt. 1,2
H 4 5/8"
8 3/4" x 7 7/8"
oz. 40 1/2

910



899

mm. 1,2
Secchiello per spumante
Sparkling wine cooler
Seau à champagne
Wein- und Sektkühler
Cubo para champany

cm. 39 x 36
H cm. 17,5
lt. 7
15 3/8" x 14 1/4"
H 7"
gal. 1 4/5

mm. 1,2
Secchiello per ghiaccio
Ice-bucket
Seau à glaçons
Eisgefäß
Cubitera hielo

cm. 22 x 20
H cm. 11,5
lt. 1,6
8 3/8" x 7 7/8"
H 4 5/8"
oz. 54

570



mm. 1,2
Cremiera
Cream jug
Crémier
Sahnegießer/Milchkännchen
Jarrita lechera

Ø cm. 6 Ø 2 3/8"
H cm. 8,8 H 3 1/2"
cl. 16 oz 5 3/8

571



mm. 1,2
Zuccheriera
Sugar bowl
Sucriere
Zuckerdose
Azucarero

Ø cm. 9,5 Ø 3 3/4"
H cm. 6,8 H 2 3/4"
cl. 20 oz 6 3/4

514

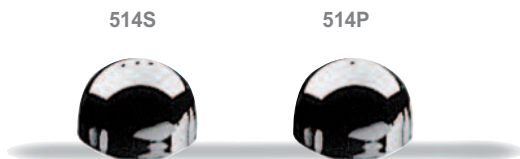

mm. 0,8
GIOTTO
Spargisale e Spargipepe
Salt and pepper cellar
Salière et poivrère
Salz und Pepper-streuer
Salero y pimentero

Ø cm. 3 Ø 1 1/6"
H cm. 3 H 1 1/6"
cl. 5 oz. 1 2/3

999C

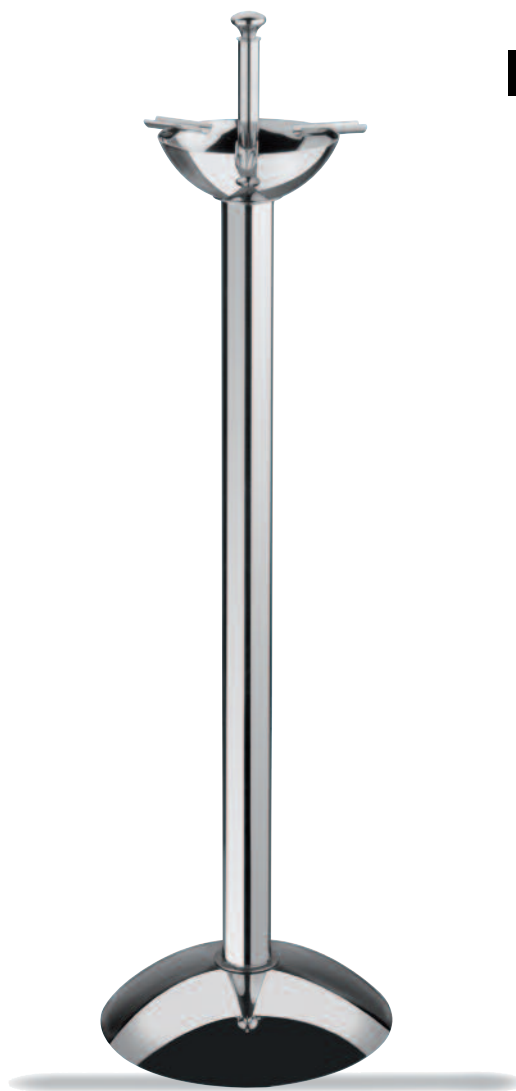

719



mm. 1,2
Bicchiere termico
Insulated shot glass
Shot-verre thermique
Warmhalter Shot Glass
Vaso térmico por chupito

Ø cm. 5 Est. Ø 2" Out.
Ø cm. 4 Int. Ø 1 3/5" Ins.
H cm. 6,3 H 2 1/2"
cl. 6 oz. 2

mm. 1,2
Posacenere a colonna
Ashtray column
Borne étouffoir
Ascherständer
Cenicero à columna

H cm 91,5 H 36"

26202



mm. 1,2 Centrotavola/Fruttieria ovale 2p cm. 46 x 31 18¹/₈" x 12¹/₄"
 Elevated centerpiece/Fruit-bowl cm. 37 x 25 14¹/₂" x 9⁷/₈"
 Centre de table/Compotier H cm. 28 H 11¹/₈"
 Tafelaufsatz/Obstschale lt. 6,5 gal. 1⁵/₇
 Centro de mesa/Fruterio

242



mm. 1,2 Centrotavola/Fruttieria tonda Ø cm. 32 Ø 12⁵/₈"
 Elevated centerpiece/Fruit-bowl H cm. 19 H 7¹/₂"
 Centre de table/Compotier lt. 3,0 oz. 101²/₅
 Tafelaufsatz/Obstschale
 Centro de mesa/Fruterio

26203



mm. 1,2 Centrotavola/Fruttieria ovale 3p cm. 46 x 31 18¹/₈" x 12¹/₄"
 Elevated centerpiece/Fruit-bowl cm. 37 x 25 14¹/₂" x 9⁷/₈"
 Centre de table/Compotier 3et. Ø cm. 12 Ø 4³/₄"
 Tafelaufsatz/Obstschale 3-Stu. H cm. 37 H 14¹/₂"
 Centro de mesa/Fruterio 3pisos lt. 6,7 gal. 1³/₄

24202



mm. 1,2 Centrotavola/Fruttieria tonda 2 piani Ø cm. 32 Ø 12⁵/₈"
 Elevated centerpiece/Fruit-bowl 2t Ø cm. 22 Ø 8⁵/₈"
 Centre de table/Compotier 2 et. H cm. 29,5 H 11³/₅"
 Tafelaufsatz/Obstschale 2-Stufig lt. 4,3 gal. 1¹/₈
 Centro de mesa/Fruterio 2 pisos

26204



mm. 1,2 Centrotavola/Fruttieria ovale 4p cm. 55 x 24 21⁵/₈" x 9¹/₂"
 Elevated centerpiece/Fruit-bowl cm. 46 x 31 18¹/₈" x 12¹/₄"
 Centre de table/Compotier 4et. cm. 37 x 25 14¹/₂" x 9⁷/₈"
 Tafelaufsatz/Obstschale 4-Stu. Ø cm. 12 Ø 4³/₄"
 Centro de mesa/Fruterio 4pisos H cm. 49 H 19¹/₃"
 lt. 7,2 gal. 2

871



mm. 1,2 Cestino portafrutta cm. 24 x 11 9¹/₂" x 4¹/₃"
 Fruit basket
 Panier à fruits
 Obstschale
 Cesto porta frutas

Plateau Royal





252



mm. 1,2 Centrotavola/Fruittiera
Elevated centerpiece/Fruit-bowl
Centre de table/Compotier
Tafelaufsatz/Obstschale
Centro de mesa/Fruterio

cm.38 x 25 15" x 9 7/8"
H cm. 18 H 7 1/8"
cl. 300 oz. 101 1/2

252G



mm. 1,2 Alzata per pesce crudo
Elevated rect.seafood presentation
Serveur à poisson crude
Etagere für marinierten Fisch
Porta pescado

cm.38 x 25 15" x 9 7/8"
H cm. 18 H 7 1/8"
cl. 300 oz. 101 1/2

562V



Rettangolare fondo con vassoio
Rectangular cooling bowl for buffet with insert
Bol rectangulaire à rafraichir avec insert
Kühlschale, rechteckig mit Einsatzteile
Bandeja refrescante rectangular con inserto

cm. 38 x 25
cl. 300

15" x 9 7/8"
oz. 101 1/2

562G



Rettangolare fondo con griglia
Elevated rect.seafood presentation with grill
Bol rectangulaire à rafraichir avec grill
Kühlschale, rechteckig mit Einsatzsieb
Bandeja refrescante rectangular con rejilla

cm. 38 x 25
cl. 300

15" x 9 7/8"
oz. 101 1/2

56422V



Quadro fondo con vassoio
Square cooling bowl for buffet with insert
Bol carré à rafraichir avec insert
Kühlschale, quadr. mit Einsatzteile
Bandeja refrescante cuadrada con inserto

cm. 22x22
cl. 150

8 5/8" x 8 5/8"
oz. 50 3/4

56422G



Quadro fondo con griglia
Square individual seafood presentation with grill
Bol carré à rafraichir avec grill
Kühlschale, quadr. mit Einsatzsieb
Bandeja refrescante cuadrada con rejilla

cm. 22x22
cl. 150

8 5/8" x 8 5/8"
oz. 50 3/4

262G



mm. 1,2 Alzata per pesce crudo
Elevated oval seafood
presentation with grill
Serveur à poisson crude
Etagere für marinierten Fisch
Porta pescado

cm. 46 x 31 18 1/8" x 12 1/4"
H cm. 18 H 7 1/8"
cl. 400 gal. 1

262



mm. 1,2 Centrotavola/Frutiera
Elevated centerpiece/Fruit-bowl
Centre de table/Compotier
Tafelaufsatz/Obstschale
Centro de mesa/Fruterio

cm. 46 x 31 18 1/8" x 12 1/4"
H cm. 18 H 7 1/8"
cl. 400 gal. 1

558G



Ovale fondo con griglia
Oval seafood presentation with grill
Bol oval à rafraichir avec grill
Kühlschale, oval mit Einsatzsieb
Bandeja refrescante oval con rejilla

cm. 46 x 31
cl. 400
18 1/8" x 12 1/4"
gal. 1

558V



Ovale fondo con vassoio
Oval cooling bowl for buffet with insert
Bol oval à rafraichir avec insert
Kühlschale, oval mit Einsatzteile
Bandeja refrescante oval con inserto

cm. 46 x 31
cl. 400
18 1/8" x 12 1/4"
gal. 1

56022G



Tondo fondo con griglia
Round individual seafood presentation with grill
Bol ronde à rafraichir avec grill
Kühlschale, rund mit Einsatzsieb
Bandeja refrescante redonda con rejilla

Ø cm. 22
cl. 150
Ø cm. 8 5/8"
oz. 50 3/4

56022V



Tondo fondo con vassoio
Round cooling bowl for buffet with insert
Bol ronde à rafraichir avec insert
Kühlschale, rund mit Einsatzteile
Bandeja refrescante redonda con inserto

Ø cm. 22
cl. 150
Ø cm. 8 5/8"
oz. 50 3/4

242G



mm. 1,2 Alzata tonda per pesce crudo Ø cm.32 Ø 12 5/8"
Elevated round thirty-two stand H cm. 19 H 7 1/2"
Serviteur ronde à poisson crude lt. 3,0 oz. 101 2/5
Etagere, rund, für marinierte
Fisch Ø cm.22 Ø 8 5/8"
Porta pescado redondo H cm. 18 H 7 1/8"
lt. 1,31 oz. 44 1/3

26202G



mm. 1,2 Alzata ovale per pesce crudo 2p cm. 46 x 31 18 1/8" x 12 1/4"
Oval two tier seafood stand cm. 37 x 25 14 1/2" x 9 7/8"
Serviteur ovale à poisson crude H cm. 28 H 11 1/8"
Etagere, oval, für marinierten gal. 1 5/7
Fisch lt. 6,5
Porta pescado oval 2 pisos

24202G



mm. 1,2 Alzata tonda per pesce crudo 2p Ø cm. 32 Ø 12 5/8"
Round two tier seafood stand Ø cm. 22 Ø 8 5/8"
Servit.ronde à poisson crude 2 et. H cm. 29,5 H 11 3/5"
Etagere, rund, für marinierte Fisch lt. 4,3 gal. 1 1/8
2-Stufig
Porta pescado redondo 2 pisos

26203G



mm. 1,2 Alzata ovale per pesce crudo 3p cm. 46 x 31 18 1/8" x 12 1/4"
Oval three tier seafood stand cm. 37 x 25 14 1/2" x 9 7/8"
Serviteur ovale à poisson crude Ø cm. 12 Ø 4 3/4"
Etagere, oval, für marinierten H cm. 37 H 14 1/2"
Fisch 3 -Stufig gal. 1 3/4
Porta pescado oval 3 pisos lt. 6,7

485



APRIL cm. 15 5 7/8"
Coltello per ostriche
Oyster knife
Couteau à huîtres
Austernöffner
Cuchillo de ostras

26204G



mm. 1,2 Alzata ovale per pesce crudo 4p cm. 55 x 24 21 5/8" x 9 1/2"
Oval four tier seafood stand cm. 46 x 31 18 1/8" x 12 1/4"
Serviteur ovale à poisson crude cm. 37 x 25 14 1/2" x 9 7/8"
Etagere, oval, für marinierten Ø cm. 12 Ø 4 3/4"
Fisch 4-Stufig H cm. 49 H 19 1/3"
Porta pescado oval 4 pisos lt. 7,2 gal. 2

235G



mm. 1,2 Vassoio rotondo per pesce crudo Ø cm.38
 Round seafood tray H cm. 9
 Plateau rond à poisson crude lt. 3,0
 Tablett, rund für marinierten Fisch
 Porta pescado redondo

Ø 15"
 H 3 1/2"
 oz. 101 2/5

235

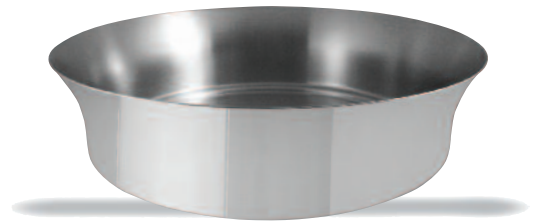

mm. 1,2 Centrotavola/Fruittiera Ø cm.38
 Centerpiece/Fruit-bowl H cm. 9
 Centre de table/Compotier lt. 3,0
 Tafelaufsatz/Obstschale
 Centro de mesa/Fruterio

Ø 15"
 H 3 1/2"
 oz. 101 2/5





Finger Food

10001129



mm. 2,5 Quarta posata

Lungh. cm. 22,2 Length 8 3/4"

25506



mm. 1,2 Micro presentoir

H cm. 13 H 5 1/9"
 Ø cm. 6 (x5) Ø 2 1/3" (x5)
 Ø cm. 8 Ø 3 1/7"

25508



mm. 1,2 Mini presentoir

H cm. 17 H 6 5/8"
 Ø cm. 8 (x5) Ø 3 1/7" (x5)
 Ø cm. 11 Ø 4 3/8"



10341146

NEW

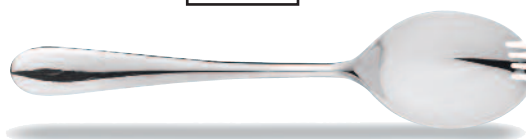

mm. 3,0 Cucchiaino multifunzione
 Multifunctional spoon
 Cuillère multifonctionnelle
 Multifunktionaler Löffel
 Cuchara multifuncional

cm. 17,6 6 8/9"

537

53706



53712



mm. 1,2 Mini vassoio quadro 6/12 comp. cm. 12 x 12 4 3/4" x 4 3/4"
6/12 comp. Mini square tray cm. 15 x 15 5 7/8" x 5 7/8"
Mini plateau carré 6/12 pos.
Mini Tablett, eckig., 6/12 Eins.
Mini bandeja cuadrada 6/12 p.

549



mm. 1,2 Vassoio rettangolare 14 comp. cm 45 x 28 17 3/4" x 11 1/8"
Rectangular tray 14 comp.
Plateau rectangulaire 14 plac.
Tablett, rechteckig 14 Eins.
Bandeja rectangular 14 posic.

520

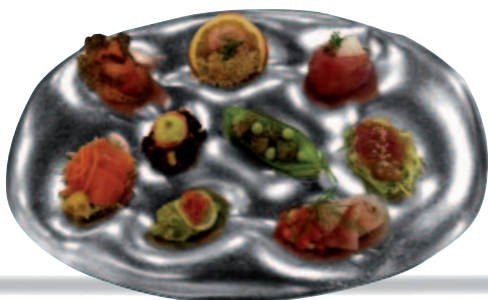

mm. 1,2 Vassoio ovale 9 compart. cm. 35 x 25,5 13 3/4" x 10"
Oval tray 9 compartments
Plateau oval 9 comp.
Tablett, oval, 9 Einsätze
Bandeja oval 9 posiciones

791E

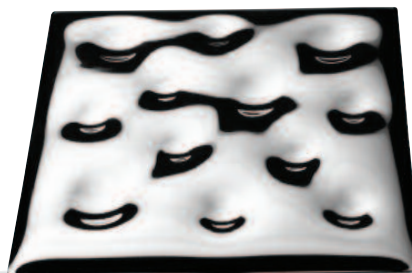

mm. 1,2 Vassoio da buffet per uova cm. 30 x 30 11 7/8" x 11 7/8"
Egg tray for buffet
Plateau à oeufs pour buffet
Egg-tablett für Buffet
Bandeja porta huevos por buffet

52922



mm. 1,2 Vassoio quadro 8 compart. cm. 22 x 22 8 5/8" x 8 5/8"
8 comp. Square tray
Plateau carré 8 pos.
Tablett, eckig., 8 Eins.
Bandeja cuadrada 8 posic.

526

04

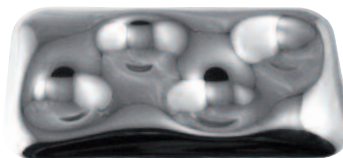

03



mm. 1,2 Vassoio rettangolare a 3 o 4 comp. cm. 23 x 13 9" x 5 1/8"
Rectangular tray 3 or 4 comp.
Plateau rectangulaire 3 ou 4 plac.
Tablett, rechteckig 3 oder 4 Eins.
Bandeja rectangular 3 o 4 posic.

FINGER FOOD

791AC



mm. 1,2 Insetto per finger food
Finger food insert
Insért pour finger food
Finger food Einsatz
Insetto por finger food

cm. 30 x 30 117/8" x 117/8"

791



Vassoio/Sottopiatto
Square Tray/Charger
Plateau/Assiette de bienvenue
Tablett/Platzteller,
Bandeja/Bajo plato

cm. 32 x 32 123/4" x 123/4"

700



mm. 1,2 Portapatatine fritte
French fry holder for table
Porte pommes frites pour table
Kartoffenbehälter für Tisch
Porta patatas fritas por mesa

H cm 10 H 4"
cl. 35 oz. 11 7/8

902



mm. 1,2 Portapatatine fritte
French fry holder for table
Porte pommes frites pour table
Kartoffenbehälter für Tisch
Porta patatas fritas por mesa

H cm 8 H 3 1/4"
Ø cm 7 Ø 2 3/4"

260



mm. 1,2 Portapatatine fritte
French fry holder for table
Porte pommes frites pour table
Kartoffenbehälter für Tisch
Porta patatas fritas por mesa

Ø cm 10 H 3 3/4"
H cm 9,5 Ø 3 7/8"

289



mm. 1,2 Portapatatine fritte
French fry holder for table
Porte pommes frites pour table
Kartoffenbehälter für Tisch
Porta patatas fritas por mesa

H cm. 10 H 3 7/8"
Ø cm. 6 Ø 2"

53012



mm. 1,2 23053012
 Mini vaporiera
 Mini steamer
 Mini vaporisateur
 Mini Verdampfer
 Mini vaporizador

Ø cm. 12 Ø 4 3/4"
 H cm. 14,5 H 5 3/4"
 cl. 24 oz. 8

53022



mm. 1,2 23053022
 Vaporiera
 Steamer
 Vaporisateur
 Verdampfer
 Vaporizador

Ø cm. 32 Ø 12 5/8"
 H cm. 26 H 10 1/4"
 lt. 3,0 oz. 101 2/5



FINGER FOOD

557T



557

557T

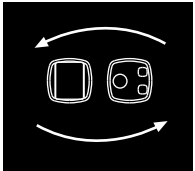

Combinabile con
Ciotole in vetro
Ciotole in policarbonato
Ciotole in porcellana
Coperchio in acciaio
inossidabile 18/10

Combinable with
Glass bowls
Polycarbonate bowls
China bowls
18/10 st.st. lid

Combinable avec
Bols en verre
Bols en Polycarbonat
Bols en porcelaine
Couvercle en acier
inoxydable18/10

Kombinierbar mit
Glasschalen
Polycarbonatschalen
Porzellanschalen
18/10-Deckel

Combinable con
Cuencos en cristal
Cuencos en policarbonato
Cuencos en China
Tapa en acero inoxidable
18/10

561M



56138

561M

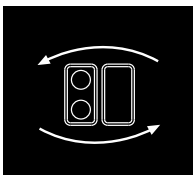

Combinabile con
Ciotole in vetro
Ciotole in policarbonato
Vassoio in acciaio
inossidabile 18/10

Combinable with
Glass bowls
Polycarbonate bowls
Tray in 18/10
stainless steel

Combinable avec
Bols en verre
Bols en Polycarbonat
Plateau en acier
inoxydable18/10

Kombinierbar mit
Glasschalen
Polycarbonatschalen
Edelstahlschalen

Combinable con
Cuencos en cristal
Cuencos en policarbonato
Cuencos en acero
inoxidable 18/10

561T



561T

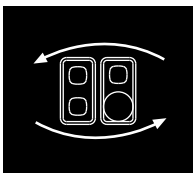

Combinabile con
Ciotole in vetro
Ciotole in policarbonato
Ciotole in porcellana
Coperchio in acciaio
inossidabile 18/10
Ampolle in vetro
Piatti in vetro

Combinable with
Glass bowls
Polycarbonate bowls
China bowls
18/10 st.st. lid
Glass bottles
Glass trays

Combinable avec
Bols en verre
Bols en Polycarbonat
Bols en porcelaine
Couvercle en acier
inoxydable18/10
Bouteilles en verre
Plateaus en verre

Kombinierbar mit
Glasschalen
Polycarbonatschalen
Porzellanschalen
18/10-Deckel
Karaffen
Glasplatten

Combinable con
Cuencos en cristal
Cuencos en policarbonato
Cuencos en China
Tapa en acero inoxidable
18/10
Botellas en vidrio
Platos en vidrio



56122

561M

561T

FINGER FOOD

563T15

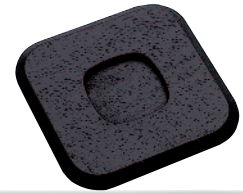

56315

563T15

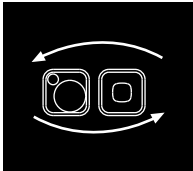

Combinabile con
Ciotole in vetro
Ciotole in policarbonato
Ciotole in porcellana
Coperchio in acciaio
inossidabile 18/10
Ampolle in vetro

Combinable with
Glass bowls
Polycarbonate bowls
China bowls
18/10 st.st. lid
Glass bottles

Combinable avec
Bols en verre
Bols en Polycarbonat
Bols en porcelaine
Couvercle en acier
inoxydable 18/10
Bouteilles en verre

Kombinierbar mit
Glasschalen
Polycarbonatschalen
Porzellanschalen
18/10-Deckel
Karaffen

Combinable con
Cuencos en cristal
Cuencos en policarbonato
Cuencos en China
Tapa en acero inoxidable
18/10
Botellas en vidrio

563T22



56322

563T22

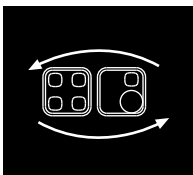

Combinabile con
Ciotole in vetro
Ciotole in policarbonato
Ciotole in porcellana
Coperchio in acciaio
inossidabile 18/10
Ampolle in vetro

Combinable with
Glass bowls
Polycarbonate bowls
China bowls
18/10 st.st. lid
Glass bottles

Combinable avec
Bols en verre
Bols en Polycarbonat
Bols en porcelaine
Couvercle en acier
inoxydable 18/10
Bouteilles en verre

Kombinierbar mit
Glasschalen
Polycarbonatschalen
Porzellanschalen
18/10-Deckel
Karaffen

Combinable con
Cuencos en cristal
Cuencos en policarbonato
Cuencos en acero
inoxidable 18/10
Botellas en vidrio

563T22



567

563T22

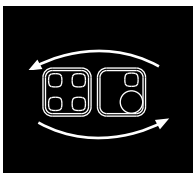

Combinabile con
Ciotole in vetro
Ciotole in policarbonato
Ciotole in porcellana
Coperchio in acciaio
inossidabile 18/10
Ampolle in vetro

Combinable with
Glass bowls
Polycarbonate bowls
China bowls
18/10 st.st. lid
Glass bottles

Combinable avec
Bols en verre
Bols en Polycarbonat
Bols en porcelaine
Couvercle en acier
inoxydable 18/10
Bouteilles en verre

Kombinierbar mit
Glasschalen
Polycarbonatschalen
Porzellanschalen
18/10-Deckel
Karaffen

Combinable con
Cuencos en cristal
Cuencos en policarbonato
Cuencos en acero
inoxidable 18/10
Botellas en vidrio



578

577

584

587

585

572

572A

352

A close-up photograph of a silver heart-shaped mold being filled with red wine. The mold is placed on a white, textured napkin. A stream of red wine is being poured from a white ceramic pitcher into the mold. The entire scene is set on a white ceramic tray with a textured border, which is placed on a brown, perforated metal surface. The lighting is warm and focused on the heart-shaped mold.

748
Porta sorpresa

Specialist



260 Vaso

703AC Piattino



744
Cestino

750
Microforchetta



753
Alzata

920
Appoggia posate



919
Cestino Palace



Quarta Posata

754
Vassoio

748



mm. 1,2 Porta sorpresa
Surprises set
Porte-surprises
Universalträger
Puerta sorpresas

703AC



mm. 1,2 Piattino
Tray
Plat
Tablett
Bandeja
Ø cm. 10 Ø 3 7/8"

260



mm. 1,2 Vaso
Jar
Vase
Vase
Florero

H cm. 9,5 H 3 3/4"
Ø cm. 10 Ø 3 7/8"

744



mm. 1,2 Cestino
Basket
Corbeille
Früchtekorb
Cesta

H cm. 11,5 H 4 1/2"
Ø cm. 10 Ø 3 7/8"

750



mm. 1,5 Micro forchetta
Micro fork
Micro fourchette
Mikrogabel
Micro tenedor

743



mm. 1,2 Cestino
Basket
Corbeille
Früchtekorb
Cesta

H cm. 11,5 H 4 1/2"
Ø cm. 10 Ø 3 7/8"

753



mm. 1,2
Alzata
Holder
Serviteur
Etagere
Frutero

H cm. 16 H 6 1/3"
Ø cm. 12 Ø 4 3/4"

920



mm. 1,2 Appoggia posate cm. 10 x 8 4" x 3 1/7"
Knife rest
Soutier p/couverts
Besteck Ablage
Apoyo p/cubiertos

919



mm. 1,2 Cestino con maniglie
Basket with handles
Corbeille avec poignée
Schale mit Griffen
Frutero con asas

H cm. 11,5 H 4 1/2"
Ø cm. 12 Ø 4 3/4"
cl. 26 OZ 8 4/5

754



mm. 1,2 Vassoio con fori Ø cm. 28,5 Ø 11 1/5"
Tray with holes
Plateau avec trous
Tablett mit Löchern
Bandeja con agujeros

523



mm. 1,2 Mini cestello con coperchio
Mini basket with lid
Mini corbeille avec couvercle
Mini Schale mit Deckel
Mini cuenco con tapa

H cm. 10 H 4"
Ø cm. 9,4 Ø 3 5/7"

501

500

739



mm. 1,2 Cestino con coperchio
Basket with lid
Corbeille avec couvercle
Schale mit Deckel
Cuenco con tapa

H cm. 16 H 6 1/3"
Ø cm. 12 Ø 4 3/4"
cl. 26 OZ 8 4/5

718



mm. 1,2 Tumbler

H cm. 8,2 H 3 1/4"
 Ø cm. 7,2 Ø 3 4/5"
 cl. 30 oz. 10 1/7

916



mm. 1,2 Poggia pane
 Tray for bread
 Plateau pour pan
 Brot Tablett
 Bandeja por pan

Ø cm. 19,7 Ø 7 3/4"

918

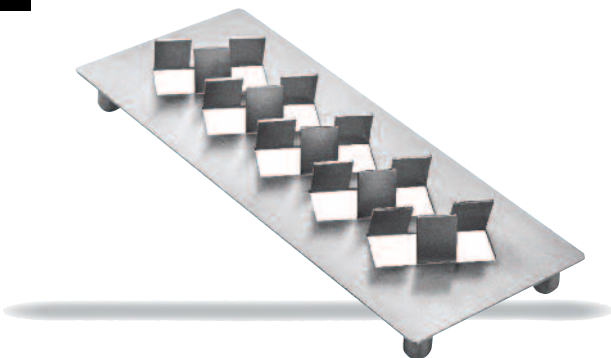

mm. 1,2 Porta crackers
 Crackers holder
 Porte craquelins
 Cracker Schale
 Puerta galletas saladas

cm. 20 x 8 7 7/8" x 3 1/7"

872



mm. 1,2 Portagrissini
 Bread sticks tray
 Porte gressin
 Grissini Schale
 Cuenco porta bastoncillos
 de pan

cm. 24 x 6 H 9 3/8" x 2 2/3"

717



mm. 1,2 Saucière cl. 4 oz. 4

738



mm. 1,2 GIOTTO
 Coppetta con vassoio
 Cup and tray
 Coupe avec plateau
 Schale mit Tablett
 Cuenco con bandeja

Ø cm. 9
 Ø 3 1/2"

Coppetta amouse bouche
 Appetizer bowl
 Bol multi-usages
 Fingerfood-/Vorspeisen-/Butter-
 Gefäß
 Cuenco para finger food/amouse
 bouche

cm. 13 x 7
 cl. 4
 5 1/9" x 2 3/4"
 oz. 4

740



745
Vassoio
petit four



742
Piattino pasticceria



747
Porta bon bon



Vassoio petit four
745



990
Coppetta con vassoio



745
Vassoio petit four



742
Piattino
pasticceria



746
Vassoietto
petit four



914



mm. 1,2 PALACE
Vassoietto
Tray
Plateau
Tablett
Bandeja

cm. 13 x 7 5 1/9" x 2 3/4"

737



mm. 1,2 GIOTTO
Vassoietto
Tray
Plateau
Tablett
Bandeja

cm. 13 x 7 5 1/9" x 2 3/4"

745



mm. 1,2 Vassoio petit four
Petit-fours tray
Plateau petit-fours
Petit-Fours Tablett
Porta dulces

cm. 26 10 1/4"

746



mm. 1,2 Vassoietto petit four
Petit-fours tray
Plateau petit-fours
Petit-Fours Tablett
Porta dulces

cm. 17,5 6 7/8"

742



Piattino per pasticceria H cm. 17,5 H 6 7/8"
Petit-fours stand Ø cm. 14 Ø 5 1/2"
Porte-petit fours
Mokkaétagère
Porta dulces
mm. 1,2

990



PALACE
Coppetta con vassoio
Cup and tray
Coupe avec plateau
Schale mit Tablett
Cuenco con bandeja
mm. 1,2

H cm. 11,5 H 4 1/2"
Ø cm. 10 Ø 3 7/8"

747



Cestino
Basket
Corbeille
Früchtekorb
Cesta
mm. 1,2

H cm. 11,5 H 4 1/2"
Ø cm. 10 Ø 3 7/8"

990



738



746
Vassoietto
petit four

914
Vassoietto
Palace



737
Vassoietto
Giotto





Fashion

403

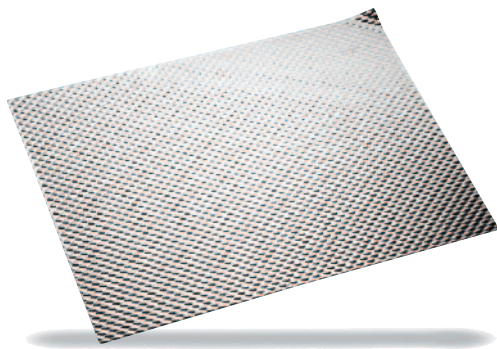

mm. 1,0 Tovaglietta americana cm. 41 x 31 16 2/5" x 12 1/4"
Place mat
Set de table americain
Tischset
Individual en acero

420

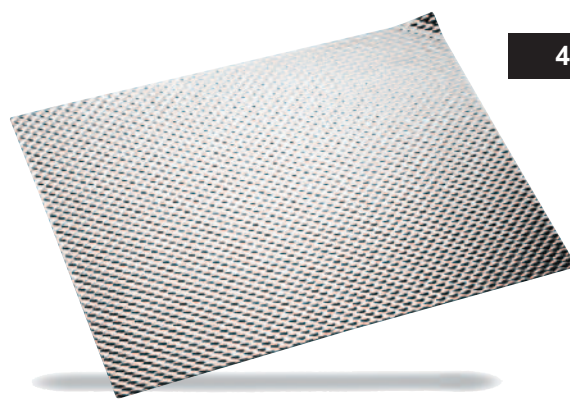

mm. 1,0 Vassoio gastronorm 1/1 cm. 53 x 32,5 20 3/4" x 12 2/3"
Tray gastronorm 1/1
Plateau gastronorm 1/1
Tablett, gastronorm 1/1
Bandeja gastronorm 1/1

416

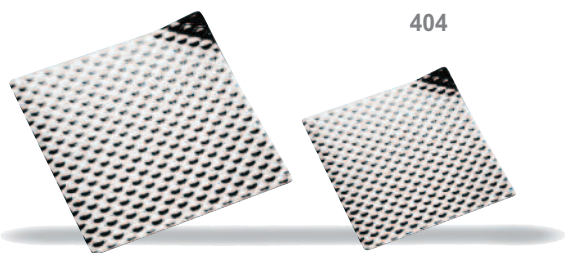

mm. 1,0 Vassoio finger food cm. 20 x 20 7 7/8" x 7 7/8"
Finger food tray
Plateau pour finger food
Finger Food Tablett
Bandeja por finger food

404
Portapane/Sottobottiglia cm. 12,5 x 12,5 5" x 5"
Bread tray/Bottle coaster
Brot Tablett/Flaschenteller
Porte pan/Dessous de
bouteille
Portapan/Posabotella

426

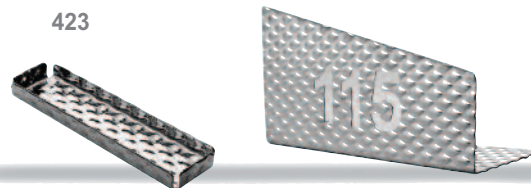

423
mm. 1,0 Portastuzzicadenti cm. 11 x 3 4 1/3" x 1 1/5"
Toothpick container
Porte-cure-dents
Zahnstocherbehälte
Porta-palillos

426
Numero da tavola cm. 15 x 8 6" x 3 1/7"
Table number stand
Numéro de table
Tischnummer-Ständer
Numero de mesa

422

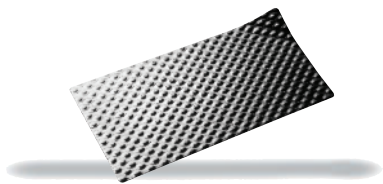

mm. 1,2 Vassoio amouse bouche cm. 20 x 10 7 7/8" x 4"
Amouse bouche tray
Plateau amouse bouche
Amouse bouche Tablett
Bandeja amouse bouche

418

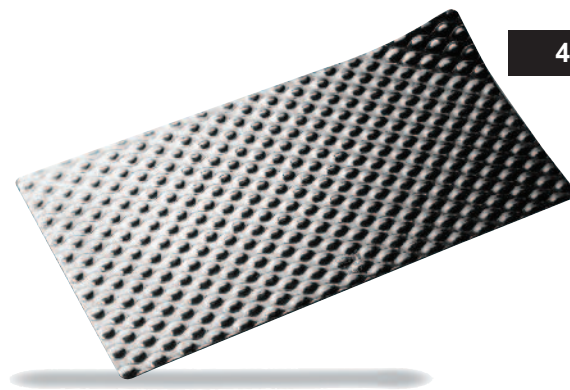

mm. 1,0 Vassoio gastronorm 2/4 cm. 53 x 16,2 20 3/4" x 6 3/8"
Tray gastronorm 2/4
Plateau gastronorm 2/4
Tablett, gastronorm 2/4
Bandeja gastronorm 2/4

417

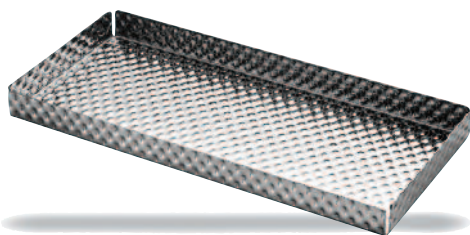

mm. 1,0 Cestino per pane e grissini cm. 26 x 12 10 1/4" x 4 3/4"
 Bread/Bread sticks basket
 Corbeille pour pan et gressin
 Brot- und Grissinikorb
 Cesta por pan y bastoncillos de pan

419

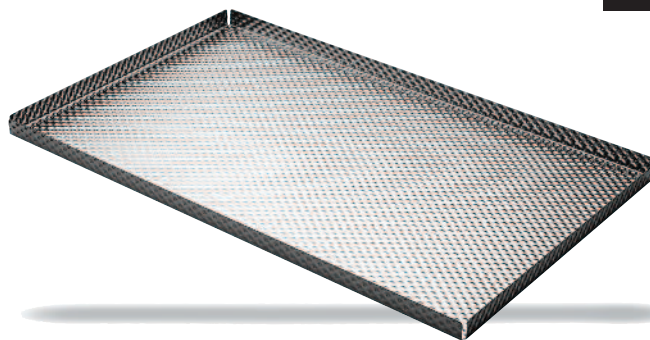

mm. 1,0 Vassoio gastronom c/bordo cm. 53 x 32,5 20 3/4" x 12 2/3"
 Tray gastronom w/edges
 Plateau gastronom a/bords
 Tablett, gastronom m/Kanten
 Bandeja gastronom c/bordes

429

NEW



mm. 1,0 Vassoio per carrelli cm. 45 x 31 17 3/4" x 12 1/4"
 Tray for rack trolley cm. 63 x 45 24 11/16" x 17 3/4"
 Plateau pour chariot porte-plateau
 Tablett für Rack
 Bandeja para estante

NEW

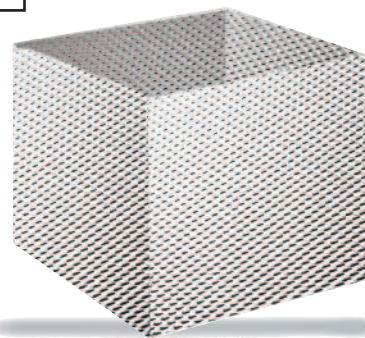

mm. 1,0 Secchiello per spumante H cm. 21 H 8 1/4"
 Sparkling wine cooler cm. 21 x 21 8 1/4" x 8 1/4"
 Seau à champagne lt. 9 gal. 2 1/2
 Wein- und Sektkühler
 Cubo para champany

430

427

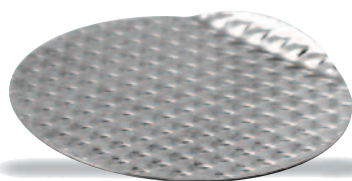

mm. 1,0 Sottobottiglia Ø cm. 10 Ø 4"
 Bottle coaster
 Dessous de bouteille
 Flaschenteller
 Posabotella

428

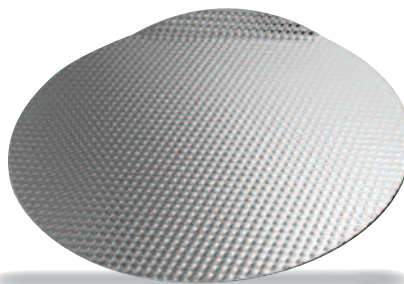

mm. 1,0 Sottopiatto Ø cm. 34 Ø 13 3/8"
 Charger
 Assiette de bienvenue
 Platzteller
 Bajo plato





Buffet 4.0

212A



mm. 1,2 Centrotavola/Fruttiara cm. 38 x 32 15" x 9 7/8"
Elevated centerpiece/Fruit-bowl H cm. 20 H 7 3/4"
Centre de table/Compotier
Tafelaufsatz/Obstschale
Centro de mesa/Fruterero

222A



mm. 1,2 Centrotavola/Fruttiara cm. 46 x 31 18 1/4" x 12 1/4"
Elevated centerpiece/Fruit-bowl H cm. 20 H 7 3/4"
Centre de table/Compotier
Tafelaufsatz/Obstschale
Centro de mesa/Fruterero

212



mm. 1,2 Centrotavola/Fruttiara cm. 38 x 32 15" x 9 7/8"
Elevated centerpiece/Fruit-bowl H cm. 13,2 H 5 1/5"
Centre de table/Compotier
Tafelaufsatz/Obstschale
Centro de mesa/Fruterero

222



mm. 1,2 Centrotavola/Fruttiara cm. 46 x 31 18 1/4" x 12 1/4"
Elevated centerpiece/Fruit-bowl H cm. 13,2 H 5 1/5"
Centre de table/Compotier
Tafelaufsatz/Obstschale
Centro de mesa/Fruterero

561



mm. 1,2 Rettangolare piano cm. 23 x 13 9" x 5 1/8"
Rectangular tray cm. 38 x 25 15" x 9 7/8"
Plateau rectangulaire
Tablett, rechteckig
Bandeja rectangular

557



mm. 1,2 Ovale piano cm. 37 x 25 14 1/2" x 9 7/8"
Oval tray cm. 46 x 31 18 1/4" x 12 1/4"
Plateau, oval
Tablett, oval
Bandeja oval

Colori disponibili
Available colors
Couleurs disponibles
Verfügbare Farben
Colores disponibles



O Onice
Onyx
Onyx
Onyx
Onice



N Nero
Black
Noir
Schwarz
Negro



W Trasparente
Transparent
Glace
Transparent
Vidrio



P Porcellana
White
Porcelain
Weiss
Porcelana



Cereali

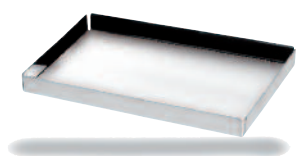

265
Vassoio per pasticceria
Patisserie tray
Plateau pour patisserie
Patisserie Tablett
Bandeja para pasteleria

cm. 24,5 x 17
cm. 30 x 21
cm. 34 x 24

9 5/8" x 6 3/4"
11 3/4" x 8 1/4"
13 3/8" x 9 1/2"

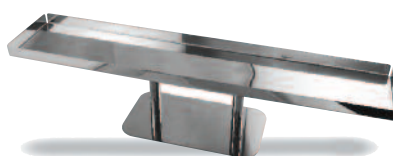

205
Vassoio per pasticceria c/pied.
Patisserie tray with foot
Plateau pour patisserie a/socle
Patisserie Tablett mit Fuss
Bandeja para pasteleria c/pies

cm. 26 x 12
cm. 60 x 12
H cm. 13

10 1/4" x 4 3/4"
23 3/5" x 10 1/5"
H 5 1/9"

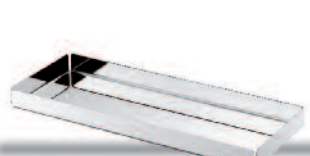

206
Vassoio per pasticceria
Patisserie tray
Plateau pour patisserie
Patisserie Tablett
Bandeja para pasteleria

cm. 26 x 12
cm. 60 x 12

10 1/4" x 4 3/4"
23 3/5" x 10 1/5"



270
Portatovaglioli
Napkin holder
Distributeur de serviettes
Serviettenhalter
Portaservilletas

cm. 12,5 x 4,5
H cm. 7

5" x 1 7/8"
H 2 3/4"

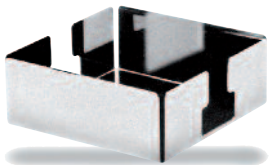

704
 Portatovaglioli
 Napkin holder
 Distributeur de serviettes
 Serviettenhalter
 Portaservilletas

cm. 13 x 13

5 1/9" x 5 1/9"



516
 Portabustine da zucchero
 Sugar packet holder
 Pot à sucre
 Zuckerstangengefäß
 Azucarera

cm. 10 x 7
 H cm. 3

4" x 2 3/4"
 H 1 1/8"



150
 Piatto concavo
 Crescent plate
 Plateau concave
 Konkave Platte
 Plato concavo

Ø cm. 14 Ø 5 1/2"
 Ø cm. 18 Ø 7"
 Ø cm. 20 Ø 7 7/8"
 Ø cm. 22 Ø 8 5/8"
 Ø cm. 24 Ø 9 1/2"
 Ø cm. 26 Ø 10 1/4"
 Ø cm. 28 Ø 11"



744
 Cestino
 Basket
 Corbeille
 Früchtekorb
 Cesta

H cm. 11,5
 Ø cm. 10

H 4 1/2"
 Ø 3 7/8"

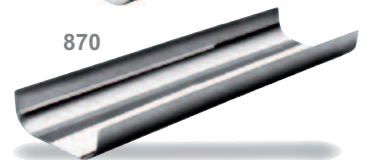
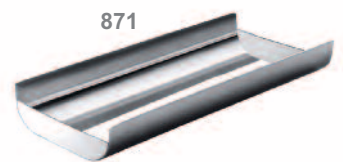

870 - 871
 GIOTTO
 Portapane / Portagrissini
 Bread / Bread sticks holder
 Porte pan / Porte gressin
 Brot und-Grissini -Schale
 Portapan / Porta bastoncillos de pan

870
 cm. 35,5 x 11
 14" x 4 1/3"

871
 cm. 24 x 11
 9 1/2" x 4 1/3"

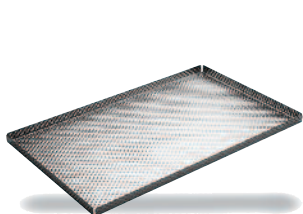

419
FASHION
Vassoio gastronom c/bordo 1/1
Tray gastronom w/edges 1/1
Plateau gastronom a/bords 1/1
Tablett, gastronom m/Kanten 1/1
Bandeja gastronom c/bordes 1/1

cm. 53 x 32,5

20 ³/₄" x 12 ²/₃"
196

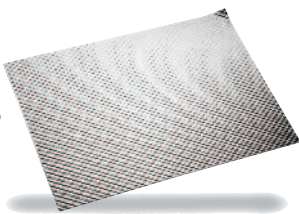

420
FASHION
Vassoio gastronom 1/1
Tray gastronom 1/1
Plateau gastronom 1/1
Tablett, gastronom 1/1
Bandeja gastronom 1/1

cm. 53 x 32,5

20 ³/₄" x 12 ²/₃"

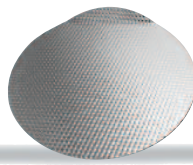

428
FASHION
Sottopiatto
Charger
Assiette de bienvenue
Platzteller
Bajo plato

Ø cm. 34

Ø 13 ³/₈"

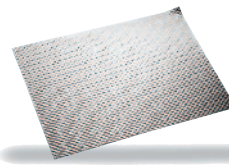

403
FASHION
Tovaglietta americana
Place mat
Set de table americain
Tischset
Individual en acero

cm. 41 x 31

12 ¹/₄" x 16 ²/₅"

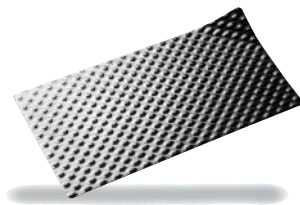

418
FASHION
Vassoio gastronom 2/4
Tray gastronom 2/4
Plateau gastronom 2/4
Tablett, gastronom 2/4
Bandeja gastronom 2/4

cm. 53 x 16,2

20 ³/₄" x 6 ³/₈"

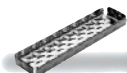
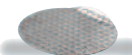
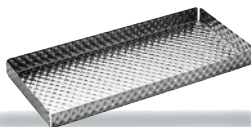
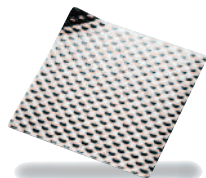
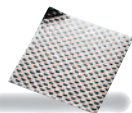
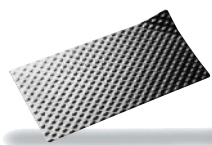

422
FASHION
Vassoio amouse buche
Amouse buche tray
Plateau amouse buche
Amouse buche Tablett
Bandeja amouse buche

cm. 20 x 10

7 7/8" x 4"

404
FASHION
Portapan/Sottobottiglia
Bread tray/Bottle coaster
Porte pan/Dessous de
bouteille
Brot Tablett/Flaschenteller
Portapan/Posabotella

cm. 12,5 x 12,5

5" x 5"

416
FASHION
Vassoio finger food
Finger food tray
Plateau pour finger food
Finger Food Tablett
Bandeja por finger food

cm. 20 x 20

7 7/8" x 7 7/8"

417
FASHION
Cestino per pane e grissini
Bread/Bread sticks basket
Corbeille pour pan et gressin
Brot- und Grissinikorb
Cesta por pan y bastoncillos
de pan

cm. 26 x 12

10 1/4" x 4 3/4"

427
FASHION
Sottobottiglia
Bottle coaster
Dess.de bouteille
Flaschenteller
Posabotella

Ø cm. 10

Ø 4"

423
FASHION
Portastuzzicadenti/Appoggiaposate
Toothpick container/Knife rest
Porte-cure-dents/Soutier p/couverts
Zahnstocherbehälter/Messer bank
Porta-palillos/Apoyo p/cubiertos

cm. 11 x 3

4 1/3" x 1 1/5"



391
H cm. 13
H 5 1/9"



387
H cm. 10
H 4"



382
H cm. 7,5
H 3"



383
H cm. 5,5
H 2 1/6"

Basi
Risers
Stands de buffet
Buffetständer
Soportes de buffet



390
H cm. 6
H 2 1/3"



388
H cm. 7,4
H 2 7/8"



389
H cm. 14
H 5 1/2"



386
H cm. 7,5
H 3"



385
H cm. 3,0
H 1 1/4"



384
H cm. 8,5
H 3 3/8"



Buffet

682



TU0687G

mm. 0,8

Caraffa per bibite
Jug for drinks w/ice container
Carafe avec compartiment glaçons
Saftkrug mit Kühleinsatz
Jarra agua

lt. 2,5 84 1/2 oz.

691



TU0692V

mm. 0,8

Infusiera con contenitore trasparente
Infuser jug
Carafe d'eau avec infuseur
Wasserkrug mit Infuser
Jarra de agua de infusión

lt. 2,5 84 1/2 oz.

68702



TU0687G

mm. 0,8

AURORA
Caraffa per bibite
Jug for drinks w/ice container
Carafe avec compartiment glaçons
Saftkrug mit Kühleinsatz
Jarra agua

lt. 2 67 3/4 oz.

69202



TU0692V

mm. 0,8

AURORA
Infusiera con contenitore trasparente
Infuser jug
Carafe d'eau avec infuseur
Wasserkrug mit Infuser
Jarra de agua de infusión

lt. 2 67 3/4 oz.

BUFFET

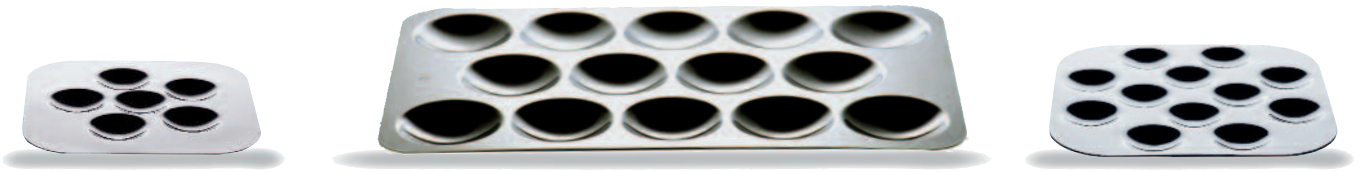



549

537



mm. 1,2 Centrotavola
Tray 14 compartments
Plateau 14 pièces
Tablett 14 Einsätze
Bandeja 14 posiciones

53706



mm. 1,2 Mini vassoi per finger food
Mini trays for finger food
Mini plateau pour finger food
Mini Tablett für finger food
Mini bandejas por finger food

53712



cm. 12 x 12 4 3/4" x 4 3/4"
cm. 15 x 15 5 7/8" x 5 7/8"

cm. 45 x 28 17 3/4" x 11 1/8"

7011

7011E



cl. 9 - oz. 3

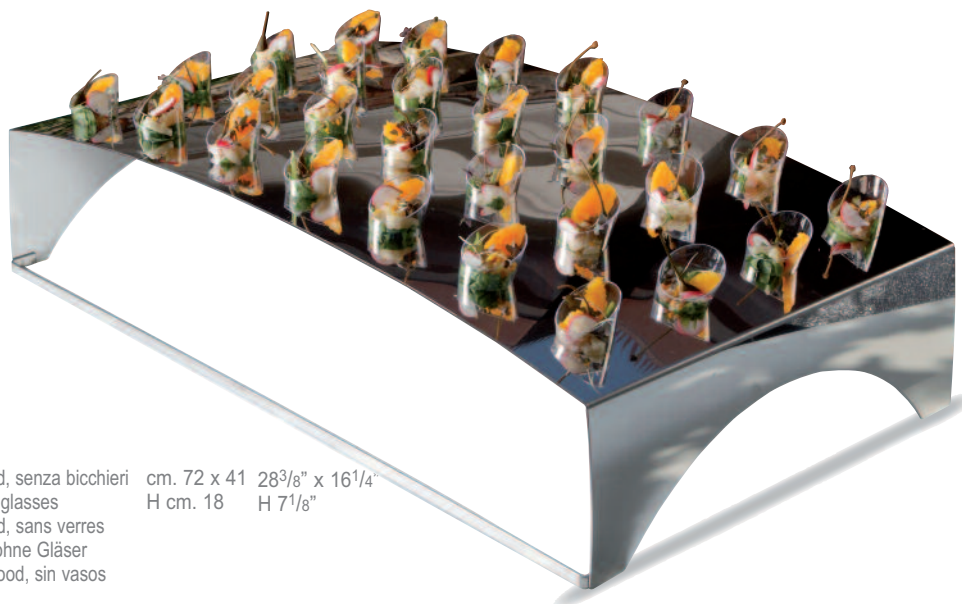

mm. 1,2 Espositore buffet per finger food, senza bicchieri
Buffet set for finger food, w/out glasses
Service à buffet pour finger food, sans verres
Buffet Display für Finger food, ohne Gläser
Servicio para buffet por finger food, sin vasos

cm. 72 x 41 28 3/8" x 16 1/4"
H cm. 18 H 7 1/8"

563

560



mm. 1,2 Quadro piano
Square tray
Plateau carré
Tablett, quadratisch
Bandeja cuadrada

cm. 15 x 15 5 7/8" x 5 7/8"
cm. 22 x 22 8 5/8" x 8 5/8"



mm. 1,2 Tondo fondo
Round bowl
Bol ronde
Obstschale, rund
Cuenco redondo

Ø cm. 12 cl. 26 Ø 4 3/4" oz. 8 3/4
Ø cm. 15 cl. 60 Ø 5 7/8" oz. 20 1/4
Ø cm. 22 cl. 131 Ø 8 5/8" oz. 44 1/3
Ø cm. 32 lt. 3,0 Ø 12 5/8" oz. 101 2/5

BUFFET



BUFFET





591P



Bicchiere
Glass
Gobelet
Glas
Vaso

H cm 13 H 5"
cl. 45 oz 15 1/4

588P



Bicchiere
Glass
Gobelet
Glas
Vaso

H cm 10 H 3 7/8"
cl. 33 oz. 11 1/8

1131



10521131

10521108

Mini Forchetta
Appetizer fork
Fourchette amouse
bouche
Minigabel
Mini tenedor

cm. 11,4 4 1/2"

Mini spoon cm. 11,4 4 1/2"

7012



Vassoio per canapè con bicchieri
Canape tray with glasses
Plateau à canape avec verres
Buffet Display mit Gläser
Bandeja para canapé con vasos

8 pz. 8 pcs
cm. 42 x 42 16 1/2" x 16 1/2"

17 pz. 17 pcs
cm. 42 x 72,5 16 1/2" x 28 1/2"

543N



Bicchiere per champagne
Champagne glass
Verre pour Champagne
Champagnerglas
Vaso por champán

H cm. 22,7 H 9"
cl. 15 oz. 5 1/8

555N



Piano per buffet
Tray for buffet
Plateau pour buffet
Buffettablett
Bandeja para buffet

Ø cm. 18 Ø 10 1/2"

543

A Ambra
Amber
Ambre
Amber
Ambar



G Granato
Garnet
Grenat
Granat
Granate



S Smeraldo
Emerald
Emeraude
Smaragd
Esmeralda



Z Zaffiro
Sapphyre
Saphir
Saphir
Zafiro



M Ametista
Amethyst
Amethyste
Amethyst
Amatista



W Trasparente
Transparent
Glace
Transparent
Vidrio



O Onice
Onyx
Onyx
Onyx
Onice



P Porcellana
White
Porcelain
Weiss
Porcelana



N Nero
Black
Noir
Schwarz
Negro



7199



PALACE
Chafing Dish rettangolare con coperchio girevole a 180°
Rectangular Chafing Dish with 180° revolving cover
Chafing Dish rectangulair avec couvercle basculant à 180°
Chafing Dish rechteckig mit 180° Rollhaube
Chafing Dish rectangular con tapa volvible à 180°

cm. 66 x 45
H cm. 43
Lt. 6,5
26" x 17 3/4"
H 17"
gal. 1 3/4

7199A



cm. 52 x 32
20 1/2" x 12 3/4"

PALACE
Zuppiera per art. 7199
Soup station for art. 7199
Marmite à potage pour art. 7199
Suppenstation für Art. 7199
Sopera para art. 7199

Ø cm. 21,5 Ø 8 1/2"

7201



PALACE
Chafing Dish tondo con coperchio girevole a 180°
Round Chafing Dish with 180° revolving cover
Chafing Dish rond avec couvercle basculant à 180°
Chafing Dish rund mit 180° Rollhaube
Chafing Dish rendono con tapa volvible à 180°

Ø cm. 40
H cm. 46
Lt. 4,5
Ø 15 3/4"
H 18 1/8"
gal. 1 1/4

Ø cm. 38,5 esterno
Ø cm. 22 interno

Ø 15 1/8" outside
Ø 8 3/4" inside

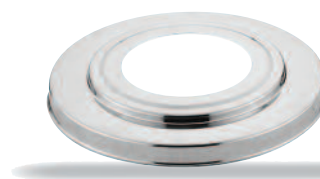

7201A

Ø cm. 21,5 Ø 8 1/2"

PALACE
Zuppiera per art. 7201
Soup station for art. 7201
Marmite à potage pour art. 7201
Suppenstation für Art. 7201
Sopera para art. 7201

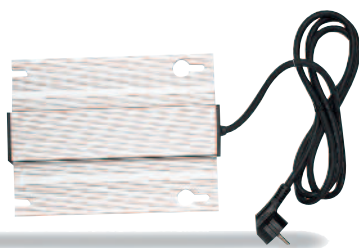

Piastra elettrica per art. 7199
Electric Heater for art. 7199
Element de chauffage électrique pour art. 7199
Heizelement für Art. 7199
Calientador eléctrico para art. 7199

7199B 110V
7199C 220V
cm. 25 x 19
9 3/4" x 7 1/2"

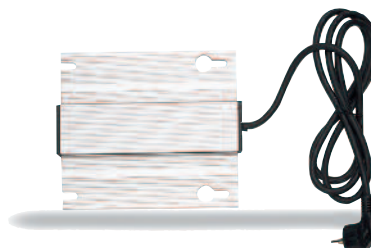

Piastra elettrica per art. 7201
Electric Heater for art. 7201
Element de chauffage électrique pour art. 7201
Heizelement für Art. 7201
Calientador eléctrico para art. 7201

7201B 110V
7201C 220V

cm. 21,5 x 18,5
8 1/2" x 7 1/4"

151



mm. 1,2 Vassoio rettangolare
Rectangular tray
Plateau de presentation
Tablett, rechteckig
Bandeja rectangular

cm. 63 x 45
24 11/16" x 17 3/4"

7204



Coffee Urn
Coffee Urn
Bouilleur
Kaffeespender
Contenedor para café

| | | |
|--------|----------|------------|
| PALACE | Ø cm. 32 | gal. 2 3/4 |
| " | H cm. 60 | H 23 5/8" |
| " | lt. 11 | Ø 12 5/8" |
| " | Ø cm. 32 | Ø 12 5/8" |
| " | H cm. 67 | H 26 7/8" |
| " | lt. 19 | gal. 5 |

7206



Distributore per succo di frutta
Juice dispenser
Distributeur à jus
Saftdispenser
Contenedor para zumo de fruta

| | | |
|--------|-------------|-------------------|
| PALACE | cm. 26 x 35 | 10 1/4" x 13 3/4" |
| " | H cm. 58 | H 22 7/8" |
| " | lt. 7 | gal. 1 7/8 |
| " | " | " |
| " | " | " |

7208



Doppio distributore per succo di frutta
Double Juice dispenser
Double distributeur à jus
Doppel Saftdispenser
Doble contenedor para zumo de fruta

| | |
|--------|---------------|
| PALACE | cm. 56 x 35 |
| " | H cm. 58 |
| " | lt. 14 |
| " | 22" x 13 3/4" |
| " | H 22 7/8" |
| " | gal. 3 1/2 |

HAPPY

10001175



Nuovo sistema per il servizio delle pietanze, per evitare la caduta delle posate all'interno degli chafing. Tutta la collezione HAPPY è a pag. 98.

A new collection of serving pieces designed with a handle that securely rests on the edge of the chafing dish when not in use. The entire Happy collection can be found on page 98.

Nouveau système pour le service des plats, pour éviter la chute des couverts à l'intérieur des chafing. Toute la collection HAPPY est au pag. 98.

"HAPPY" ist eine neue platzsparende Idee, wie man von Chafing Dishes Speisen auf Teller füllen kann, ohne dass die Servierteile hineinfallen. Gesamte HAPPY Kollektion auf Seite 98.

Nuevo sistema por el servicio de las comidas, para evitar la caída de los cubiertos dentro de los chafing. Toda la colección HAPPY es a pag. 98.

Apoggia posate
Knife rest
Soutier p/couverts
Messer bank
Apoyo p/cubiertos

Ø mm.10

Largh. cm 6,5
Width 2 1/2"

BUFFET

7087



Chafing Dish 1/1 rettangolare con coperchio amovibile cm. 61 x 30 24" x 11 3/4"
 Rectangular Chafing Dish 1/1 with removable cover H cm. 32,5 H 12 3/4"
 Chafing Dish 1/1 rectangulaire avec couvercle démontable lt. 6,5 gal. 1 3/4
 Chafing Dish 1/1 rechteckig mit abnehmbarer Haube
 Chafing Dish 1/1 rectangular con tapa amovible

7086

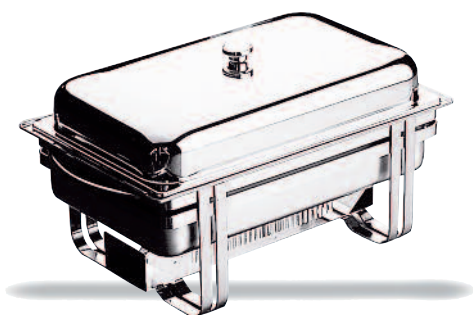

GIOTTO
 Chafing Dish 1/1 rettangolare con coperchio amovibile cm. 61 x 30
 Rectangular Chafing Dish 1/1 with removable cover H cm. 32,5
 Chafing Dish 1/1 rectangulaire avec couvercle démontable lt. 6,5
 Chafing Dish 1/1 rechteckig mit abnehmbarer Haube 24" x 11 3/4"
 Chafing Dish 1/1 rectangular con tapa amovible H 12 3/4"
 gal. 1 3/4

7090



mm. 0,8 Rinfrescatore per yogurt cm. 52,5 x 32,5 20 5/8" x 12 3/4"
 Yogurt cooler lt. 8 gal. 2
 Rafrachisseur à yaourts
 Yoghurtkühler
 Refrigerador para yogurt

236



mm. 1,2 Rinfrescatore per yogurt Ø cm.38
 Yogurt cooler H cm. 9
 Rafrachisseur à yaourts lt. 3,0 Ø 15"
 Yoghurtkühler oz. 101 2/5
 Refrigerador para yogurt

BUFFET

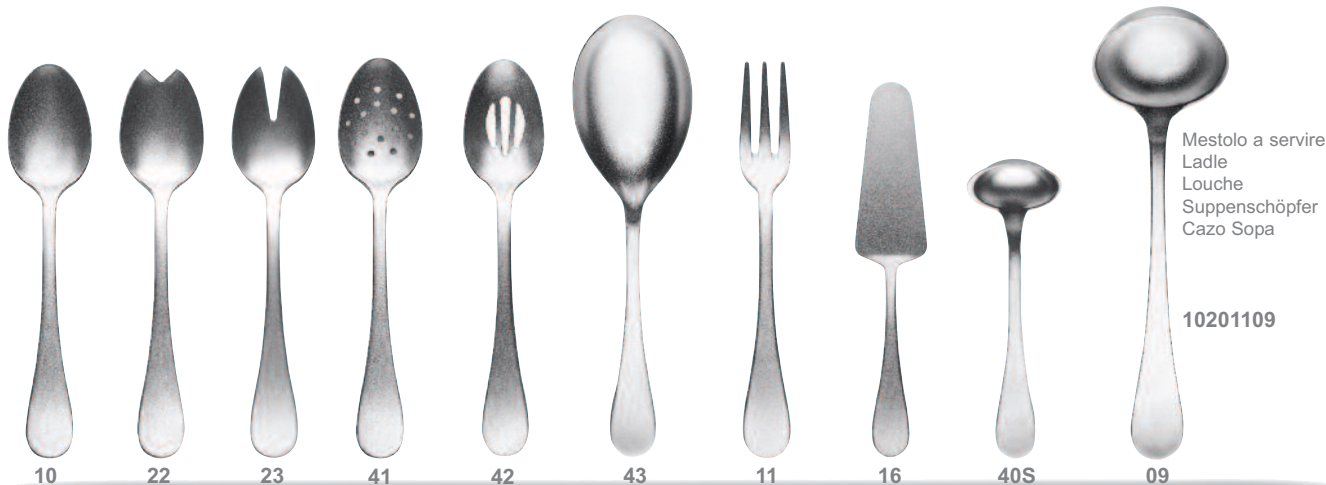

10

22

23

41

42

43

11

16

40S

09

Cucchiaione
 Cooking spoon
 Cuillère à légumes/
 à ragût
 Gemüseöffel
 Cuchara legumbres

Cucchiaio insalata
 Salad serving
 spoon
 Cuillère à salade
 servir
 Salatvorlegelöffel
 Cuchara servir
 ensalada

Forchetta Insalata
 Salad serving fork
 Fourchette
 à salade servir
 Salatvorlegegabel
 Tenedor servir
 ensalada

Cucchiaione
 con fori
 Serving spoon
 w/holes
 Cuillère a/trous
 Servierlöffel
 m/Löchern
 Cuchara
 c/agujeros

Cucchiaione
 con asole
 Serving spoon
 w/slots
 Cuillère a/oieilles
 Servierlöffel
 m/Ösen
 Cuchara
 c/ojales

Cucchiaio risotto
 "Risotto" spoon
 Cuillère "Risotto"
 Reislöffel
 Cuchara arroz seco

Forchettone a servire
 Serving fork
 Fourchette à légumes/
 à servir
 Fleischgabel
 Tenedor legumbres

Pala per Torta
 Cake trowel
 Pelle à tarte
 Tortenheber
 Pala tarta

Mestolo a servire
 Ladle
 Louche
 Suppenschöpfer
 Cazo Sopa

10201109

10201110

10201122

10201123

10201141

10201142

10201143

10201111

10201116

10201140S

7999

7999



"MATHUSALEM"
lt. 6 - gal. 1 1/2

"SALMANAZAR"
lt. 9 - gal. 2 1/2

Culla portachampagne "MATHUSALEM" lt. 6 - gal. 1 1/2
 Champagne holder "SALMANAZAR" lt. 9 - gal. 2 1/2
 Porte-champagne
 Champagnerflaschenhalter cm 45 x 31 - H cm 65
 Portabotella de champagne 17 3/4" x 12 1/4" - H 25 1/2"

NEW

BUFFET

NEW

769



Molla per zucchero ed aperitivi
Sugar and cocktails tongs
Pince à sucre et apéritifs
Zucker- und Cocktailszange
Pinzas azúcar y aperitivos
mm. 1,2

Lungh. cm. 10,8

Length 4 1/4"

768



Molla per Finger food
Finger food tongs
Pince à amuse-bouche
Fingerfoodzange
Pinzas por finger food
mm. 1,2

Lungh. cm. 15

Length 6"

766



Molla per ghiaccio e limone
Ice and lemon tongs
Pince à glaçon et citron
Eis- und Zitronenzange
Pinzas hielo y limón

Lungh. cm. 15

Length 6"

767



Molla per pasticceria
Pastry tongs
Pince à gateaux
Gebäckzange
Pinzas dulces
mm. 1,2

Lungh. cm. 18

Length 7"

763



Molla per pane e dolci
Bread and cakes tongs
Pince à pain et gateaux
Brot- und Süßenzange
Pinzas para pan y dulces
mm. 1,2

Lungh. cm. 22

Length 8 2/3"

765



Molla per arrosto e verdure
Roasts and vegetables tongs
Pince à salade et à rôti
Servierzange
Pinzas asado y verduras
mm. 1,2

Lungh. cm. 22

Length 8 2/3"

760



Molla per spaghetti
Spaghetti/Pasta tongs
Pince à spaghetti
Spaghettizange
Pinzas spaghetti
mm. 1,2

Lungh. cm. 27

Length 10 3/5"

761



Molla piana per servire
Flat serving tongs
Pince plane pour servir
Flachzange zum Servieren
Pinzas llanas para servir
mm. 1,2

Lungh. cm. 27

Length 10 3/5"

762



Molla fonda per servire
Deep serving tongs
Pince fonde pour servir
Tiefzange zum Servieren
Pinzas fundas para servir
mm. 1,2

Lungh. cm. 26,5

Length 10 2/5"





Palace

964



mm. 1,2 Vassoio rettangolare con maniglie
Rectangular Tray with handles
Plateau rectangulaire avec anses
Tablett rechteckig mit Griffen
Bandeja rectangular con asas

| | |
|-----------|---|
| cm. 40x27 | 15 ³ / ₄ " x 10 ⁵ / ₈ " |
| cm. 45x31 | 17 ³ / ₄ " x 12 ¹ / ₄ " |
| cm. 50x34 | 19 ⁵ / ₈ " x 13 ³ / ₈ " |
| cm. 60x42 | 23 ⁵ / ₈ " x 16 ¹ / ₈ " |

963GN



mm. 1,2 Vassoio rettangolare gastronomico
Rectangular gastronomic Tray
Plateau rectangulaire gastronomico
Tablett rechteckig gastronomico
Bandeja rectangular gastronomico

| | |
|---------------|---|
| cm. 53 x 32,5 | 20 ³ / ₄ " x 12 ² / ₃ " |
|---------------|---|

963



mm. 1,2 Vassoio rettangolare
Rectangular Tray
Plateau rectangulaire
Tablett rechteckig
Bandeja rectangular

| | |
|-----------|---|
| cm. 30x21 | 11 ³ / ₄ " x 8 ¹ / ₄ " |
| cm. 35x24 | 13 ³ / ₄ " x 9 ¹ / ₂ " |
| cm. 40x27 | 15 ³ / ₄ " x 10 ⁵ / ₈ " |
| cm. 45x31 | 17 ³ / ₄ " x 12 ¹ / ₄ " |
| cm. 50x34 | 19 ⁵ / ₈ " x 13 ³ / ₈ " |
| cm. 60x42 | 23 ⁵ / ₈ " x 16 ¹ / ₈ " |

966



mm. 1,2 Vassoio tondo
Round Tray
Plateau rond
Tablett rund
Bandeja redonda

| | |
|----------|-----------|
| Ø cm. 13 | Ø 5 1/8" |
| Ø cm. 19 | Ø 7 1/2" |
| Ø cm. 24 | Ø 9 1/2" |
| Ø cm. 27 | Ø 10 5/8" |
| Ø cm. 35 | Ø 13 3/4" |
| Ø cm. 40 | Ø 15 3/4" |

965



mm. 1,2 Vassoio rettangolare con piedini
Rectangular Tray with feet
Plateau rectangulaire avec socles
Tablett rechteckig mit Füßen
Bandeja rectangular con 4 pies

| | |
|-----------|---|
| cm. 30x21 | 11 ³ / ₄ " x 8 ¹ / ₄ " |
| cm. 35x24 | 13 ³ / ₄ " x 9 ¹ / ₂ " |
| cm. 40x27 | 15 ³ / ₄ " x 10 ⁵ / ₈ " |
| cm. 45x31 | 17 ³ / ₄ " x 12 ¹ / ₄ " |
| cm. 50x34 | 19 ⁵ / ₈ " x 13 ³ / ₈ " |
| cm. 60x42 | 23 ⁵ / ₈ " x 16 ¹ / ₈ " |

967



mm. 1,2 Vassoio tondo con piedini
Round Tray with feet
Plateau rond avec socles
Tablett rund mit Füßen
Bandeja redonda con 4 pies

| | |
|----------|-----------|
| Ø cm. 27 | Ø 10 5/8" |
| Ø cm. 35 | Ø 13 3/4" |
| Ø cm. 40 | Ø 15 3/4" |

950



| | | | | | |
|---------|---------------------|-----------|----------|------------|-------------|
| mm. 1,2 | Ciotola con base | Ø cm. 14 | cl. 60 | Ø 5 1/2" | oz. 20 1/4 |
| | Bowl with base | H cm. 8,8 | | H 3 1/2" | |
| | Bol avec socle | Ø cm. 20 | lt. 1,8 | Ø 7 7/8" | oz. 60 7/8 |
| | Obstschale auf Fuss | H cm. 11 | | H 4 1/2" | |
| | Cuenco con pedestal | Ø cm. 24 | lt. 3,1 | Ø 9 1/2" | oz. 104 7/8 |
| | | H cm. 14 | | H 5 1/2" | |
| | | lt. 5,1 | Ø 11" | gal. 1 1/4 | |
| | | H cm 16 | H 6 1/3" | | |

977



| | | | |
|---------|----------------------|-----------|----------|
| mm. 1,2 | Porta pasticcini | Ø cm 13 | Ø 5 1/8" |
| | Petit-fours stand | H cm 10,5 | H 4 1/8" |
| | Porte-petit fours | | |
| | Petits Fours-Ständer | Ø cm 19 | Ø 7 1/2" |
| | Porta dulces | H cm 14 | H 5 1/2" |
| | | | |

981A



| | | | |
|---------|-------------------------------------|----------|-------------------|
| mm. 1,2 | Alzata portafrutta rettang. 2 piani | cm 35x24 | 13 3/4" x 9 1/2" |
| | Rectangular fruit holder 2 layers | cm 45x31 | 17 3/4" x 12 1/4" |
| | Serviteur rectangulaire 2 etages | H cm 50 | H 19 5/8" |
| | Etagere, rechteckig 2-stufig | | |
| | Frutero rectangular 2 pisos | | |
| | | | |

981B



| | | | |
|---------|-------------------------------------|----------|-------------------|
| mm. 1,2 | Alzata portafrutta rettang. 3 piani | cm 35x24 | 13 3/4" x 9 1/2" |
| | Rectangular fruit holder 3 layers | cm 45x31 | 17 3/4" x 12 1/4" |
| | Serviteur rectangulaire 3 etages | cm 60x42 | 25 5/8" x 16 1/8" |
| | Etagere, rechteckig 3-stufig | H cm 73 | H 28 3/4" |
| | Frutero rectangular 3 pisos | | |
| | | | |

978



mm. 1,2 Porta pasticcini a 2 piani
Petit-fours stand 2 layers
Porte-petit fours 2 etages
Mokkaétagère 2 Ebenen
Porta dulces 2 pisos

| | |
|----------|-----------|
| Ø cm. 13 | Ø 5 1/8" |
| Ø cm. 19 | Ø 7 1/2" |
| H cm. 29 | H 11 3/8" |

97803



mm. 1,2 Porta pasticcini a 3 piani
Petit-fours stand 3 layers
Porte-petit fours 3 etages
Mokkaétagère 3 Ebenen
Porta dulces 3 pisos

| | |
|---------|-----------|
| Ø cm 13 | Ø 5 1/8" |
| Ø cm 19 | Ø 7 1/2" |
| Ø cm 27 | Ø 10 3/8" |
| H cm 36 | H 14 1/4" |

980B



mm. 1,2 Alzata portafrutta tonda 3 piani
Round fruit holder 3 layers
Serviteur rond 3 etages
Etagere, rund 3-stufig
Frutero redondo 3 pisos

| | |
|---------|-----------|
| Ø cm 27 | Ø 10 5/8" |
| Ø cm 35 | Ø 13 3/4" |
| Ø cm 40 | Ø 15 3/4" |
| H cm 73 | H 28 3/4" |

980A



mm. 1,2 Alzata portafrutta tonda 2 piani
Round fruit holder 2 layers
Serviteur rond 2 etages
Etagere, rund 2-stufig
Frutero redondo 2 pisos

| | |
|---------|-----------|
| Ø cm 27 | Ø 10 5/8" |
| Ø cm 35 | Ø 13 3/4" |
| H cm 50 | H 19 5/8" |

928



mm. 1,2 Vassoio rettangolare da servizio
 Rectangular service tray
 Plateau rectangulaire pour service
 Tablett rechteckig für Service
 Bandeja rectangular da servicio

| | |
|-----------|---|
| cm. 30x21 | 11 ³ / ₄ " x 8 ¹ / ₄ " |
| cm. 35x24 | 13 ³ / ₄ " x 9 ¹ / ₂ " |
| cm. 40x27 | 15 ³ / ₄ " x 10 ⁵ / ₈ " |
| cm. 45x31 | 17 ³ / ₄ " x 12 ¹ / ₄ " |
| cm. 50x34 | 19 ⁵ / ₈ " x 13 ³ / ₈ " |
| cm. 60x42 | 23 ⁵ / ₈ " x 16 ¹ / ₈ " |

927



mm. 1,2 Vassoio tondo da servizio
 Round service tray
 Plateau rond pour service
 Tablett rund für Service
 Bandeja redonda por servicio

| | |
|----------|------------------------------------|
| Ø cm. 27 | Ø 10 ⁵ / ₈ " |
| Ø cm. 35 | Ø 13 ³ / ₄ " |
| Ø cm. 40 | Ø 15 ³ / ₄ " |

959



Coppa in vetro c/piedistallo
 Glass bowl with base
 Coupe ronde en verre a/socle
 Glassobstschale rund auf Fuß
 Cuenco redondo en vidrio c/pedestal

959
 Ø cm 21,5
 H cm 29
 cl. 270

960
 Ø cm 12
 H cm 17
 cl. 45

960



959
 Ø 8¹/₂"
 H 11³/₈"
 oz. 91³/₈

960
 Ø 4³/₄"
 H 6³/₄"
 oz. 15¹/₄

982



Piatto da torta in vetro c/piedistallo
 Glass cake plate with base
 Plat pour gateau en verre a/socle
 Kuchenplatte aus Glas auf Fuss
 Plato para tarta en vidrio c/pedestal

Ø cm 33
 H cm 16
 Ø 12³/₄"
 H 6¹/₄"

958



Coppa multiservizio
 Glass bowl with sauce cap
 Coupe multifonctions
 Universalschale
 Ensaladera multiservicio

Ø cm 28
 H cm. 14
 cl. 300
 Ø 11"
 H 5¹/₂"
 oz. 101¹/₂

938



mm. 1,2 Vassoio ovale
 Oval tray
 Plateau oval
 Tablett oval
 Bandeja oval

cm. 31 x 22 12¹/₈" x 8³/₄"

937



mm. 1,2 Cestino per pane
 Oval basket
 Corbeille oval
 Brotkorb oval
 Frutero oval

cm. 31 x 22 12¹/₈" x 8³/₄"
 lt. 1,7 oz. 57¹/₂

968



mm. 2,0 Ampolla e formaggera
Cruet and cheese basin
Huillière et fromagère
Essig-Ölflasche und Käsedose
Vinagrera y quesera

cl. 22
H cm 15

oz. 7 1/2
H 5 7/8"

cl. 20

oz. 6 3/4

970

969



mm. 2,0 Salino e porta stuzzicadenti
Salt-cellar and toothpick container
Salière et porte cure-dents
Salzstreuer und Zahnstocherbehälter
Salero y palillero

cl. 8
H cm. 9

oz. 2 3/4
H 3 1/2"

971

cl. 7
H cm 7

oz. 2 3/8
H 2 3/4"

975



mm. 1,2 Chillcup
Caviar dish
Bol à caviar
Chillcup / Kaviarschale
Bol para caviar

cl. 15
Ø cm 19

oz. 5 1/8
Ø 7 1/2"

976



mm. 1,2 Servizio per antipasto
Snack server
Support à snacks
Relish-Pickles-Gestell
Entremesera

Ø cm. 20
H cm 15
cl. 15 (x3)

Ø 7 7/8"
H 5 7/8"
oz. 5 1/8 (x3)

935



mm. 1,2 Porta macaron
Macarons server
Porte macarons
Macaronsträger
Porta macaron

Ø cm 15
H cm 10

Ø 5 7/8"
H 4"

976S

976C



mm. 1,2 Portasalatini impilabile
Stackable snack server
Support à snack empilable
Stapelbare Relish-Pickles-Gestell
Servicio por entremes impilable

Ø cm. 20
cl. 15 (x3)

976C
Ø cm. 20
H cm 15
cl. 15 (x3)

Ø 7 7/8"
oz. 5 1/8 (x3)

976C
Ø 7 7/8"
H 5 7/8"
oz. 5 1/8 (x3)

951



mm. 1,2 Caffettiera con piedistallo
Coffee pot with base
Cafetière avec socle
Kaffekanne auf Fuss
Cafetera con pedestal

| | | | |
|--------|---|-------|-----------------------------------|
| Tazze | 4 | cl 34 | oz 12 ¹ / ₃ |
| Cups | 6 | cl 52 | oz 17 ² / ₃ |
| Bols | | | |
| Tassen | | | |
| Tazas | | | |

952



mm. 1,2 Teiera con piedistallo
Tea pot with base
Théière avec socle
Teekanne auf Fuss
Tetera con pedestal

| | | | |
|--------|---|-------|-------|
| Tazze | 2 | cl 37 | oz 13 |
| Cups | 6 | cl 60 | oz 21 |
| Bols | | | |
| Tassen | | | |
| Tazas | | | |

953



mm. 1,2 Lattiera con piedistallo
Milk jug with base
Pot à lait avec socle
Milchkanne auf Fuss
Jarra lechera con pedestal

| | | | |
|--------|---|-------|-----------------------------------|
| Tazze | 2 | cl 24 | oz 8 |
| Cups | 4 | cl 34 | oz 12 ¹ / ₃ |
| Bols | | | |
| Tassen | | | |
| Tazas | | | |

954



mm. 1,2 Zuccheriera con piedistallo
Sugar bowl with base
Sucrier avec socle
Zuckerdose auf Fuss
Azucarero con pedestal

| | | | |
|--------|---|-------|-------|
| Tazze | 6 | cl 27 | oz 10 |
| Cups | | | |
| Bols | | | |
| Tassen | | | |
| Tazas | | | |

957



mm. 1,2 Portabustine da zucchero
Sugar packet holder
Pot à sucre
Zuckerstangengefäß
Azucarera

| | |
|-----------------------------------|-----------------------------------|
| Ø cm 7 | H cm 9,5 |
| Ø 2 ³ / ₄ " | H 3 ³ / ₄ " |

914



mm. 1,2 Vassoietto
Tray
Plateau
Tablett
Bandeja

| |
|-----------------|
| cm. 13 x 7 |
| 5 1/9" x 2 3/4" |

982



mm. 1,2 Alzata portafrutta
Fruit holder
Serveur
Obstschale
Frutero

| | |
|------------------------------------|-----------------------------------|
| Ø cm 27 | H cm. 15 |
| Ø 10 ⁵ / ₈ " | H 5 ⁷ / ₈ " |

247

247



| Ø cm* | Ø in* |
|-------|---------|
| 7,5 | 3" |
| 10 | 4" |
| 10,5 | 4 1/16" |
| 13 | 5 1/16" |
| 13,2 | 5 1/5" |
| 14 | 5 1/2" |
| 14,5 | 5 5/7" |
| 20 | 7 7/8" |
| 22 | 8 5/8" |
| 24 | 9 1/2" |
| 26 | 10 1/4" |
| 28 | 11" |
| 30 | 11 3/4" |
| 31 | 12 1/8" |
| 32 | 12 5/8" |
| 33 | 13" |

mm. 0,8 Cloche con pomolo
Cloche with knob
Cloche
Tellercloche
Tapa con pomo

* Tabella diametri misurati al bordo del piatto
* Table of diameters, measured at the edge of the plate

984

974

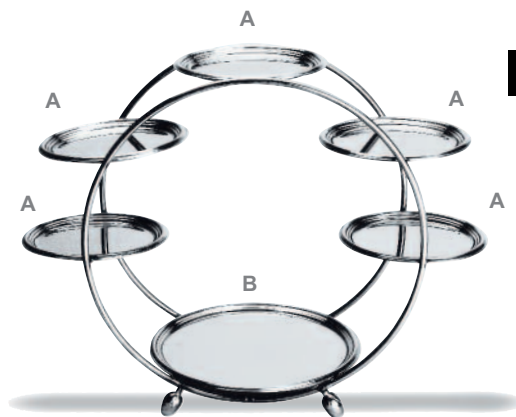
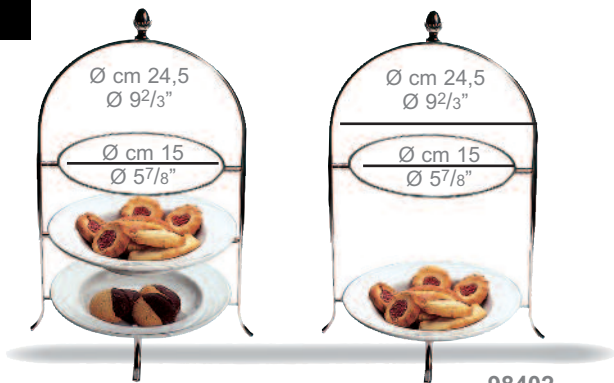

| | | | | |
|------------------------|------------|------------|--------------|-----------|
| | 984 | 984 | 98402 | |
| Alzata portapiatti | Ø cm 24 | Ø 9 1/2" | Ø cm 24 | Ø 9 1/2" |
| Afternoon tea stand | H cm.43 | H 16 7/8" | H cm.43 | H 16 7/8" |
| Présentoir à gateau | 985 | 985 | | |
| Dessert-Serviergestell | Ø cm 21 | Ø 8 1/4" | | |
| Soporte platos | H cm.37 | H 14 1/2" | | |
| | 989 | 989 | | |
| | Ø cm 30 | Ø 11 3/4" | | |
| | H cm.50,5 | H 19 7/8" | | |

mm. 1,2 Présentoir
2 misure
2 sizes
2 tailles
2 Größen
2 tamaños

| | |
|----------------|-----------------|
| A Ø cm.13 (x5) | A Ø 5 1/8" (x5) |
| B Ø cm.19 | B Ø 7 1/2" |
| A Ø cm.19 (x5) | A Ø 7 1/2" (x5) |
| B Ø cm.27 | B Ø 10 5/8" |

7092

7094



| | | |
|-----------------------|-----------------------|-----------------------|
| 7092 | 7093 | 7094 |
| Candelabro a 1 fiamma | Candelabro a 3 fiamme | Candelabro a 5 fiamme |
| Candlestick | Candelabra, 3 arms | Candelabra, 5 arms |
| Chandelier | Chandelier 3 flammes | Chandelier 5 flammes |
| Leuchter 1-flammig | Leuchter 3-flammig | Leuchter 5-flammig |
| Candelabro | Candelabro 3 luces | Candelabro 5 luces |
| Silverplated | Silverplated | Silverplated |
| H cm. 28,5 | H cm. 34,5 | H cm. 34,5 |
| H 11 1/4" | H 13 5/8" | H 13 5/8" |

972



972

mm. 1,2
972-972P
 Secchiello per ghiaccio
 Ice bucket
 Seau à glaçons
 Eisgefäß
 Cubitera hielo

Ø cm 15 Ø 5 7/8"
 H cm 18 H 7 1/8"
 cl.150 oz. 50 3/4



973



973P

mm. 1,2
973-973P
 Secchiello per spumante
 Sparkling wine cooler
 Seau à champagne
 Wein- und Sektkühler
 Cubo para champany

Ø cm 20,5 Ø 8 1/8"
 H cm 24,5 H 9 5/8"
 cl.500 gal. 1 1/3



972P

666F

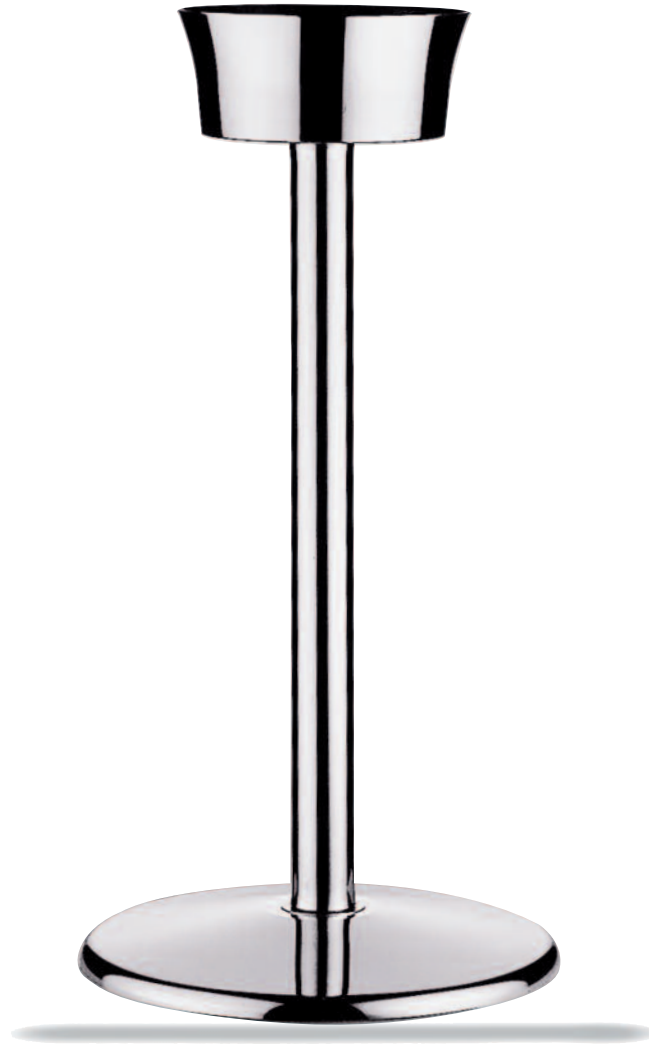

mm. 1,2
 Colonna portasecchiello spumante
 Wine cooler stand w/weighted base
 Pied pour seau à champagne
 Weinkühlerständer
 Columna porta cubo champany

H cm. 67,5 H 26 5/8"

657



mm. 0,8 Coppa per champagne con inserto
Champagne bowl with insert
Vasque a champagne avec anneau porte-verre
Champagner Bowl mit Gläser - Flaschenring
Copa para champagne con anillo

Ø cm. 38 Ø 15"
H cm. 29,5 H 11 5/8"
lt. 15 gal. 4

949



mm. 1,2 Supporto per informazioni o menu
Menu / Card holder
Porte nom numéro de table
Karten-Speisekartenhalter
Porta informaciones o menu

Ø cm. 10 Ø 4"
H cm. 10 H 4"

986



mm. 0,8 Alzata per crudité rettangolare
Rectangular seafood presentation
Serviteur à poisson crude rectang.
Etagere, rech., für marinierte Fisch
Porta pescado rectangular

cm. 53 x 32,5 20 3/4" x 12 2/3"
H cm. 9 H 3 1/2"
lt. 9,0 gal. 2

mm. 2,0 Portanumero
Table number stand
Numbers etched to order
Porte numéro de table
Tischnummernständer
Porta numero de mesa

A
Ø cm 13 Ø 5 1/8"
H cm 54 H 21 1/4"

B
Ø cm 13 Ø 5 1/8"
H cm 30 H 11 7/8"

995



987



mm. 0,8 Alzata per crudité rettangolare
Elevated rectangular seafood presentation
Serviteur à poisson crude rectang.
Etagere, rech., für marinierte Fisch
Porta pescado rectangular

cm. 53 x 32,5 20 3/4" x 12 2/3"
H cm. 25,8 H 10 1/7"
lt. 9,0 gal. 2

mm. 0,8 Rinfrescatore con piedini
Yogurt cooler with feet
Rafrachisseur à yaourts a/socles
Yoghurtkühler mit Füßen
Refrigerador para yogurt con pies

Ø cm 35 Ø 13 3/4"
H cm. 12 H 4 3/4"
lt. 2,0 oz. 67 3/5

253



983

944



mm. 1,2 Zuppiera
 Soup tureen
 Soupière
 Suppenterrine
 Sopera

| | |
|--------------------|-------------------------|
| Ø cm. 14 - lt. 0,6 | Ø 5 1/2" - oz. 20 1/4 |
| Ø cm. 18 - lt. 1,2 | Ø 7" - oz. 40 5/8 |
| Ø cm. 20 - lt. 1,8 | Ø 7 7/8" - oz. 60 7/8 |
| Ø cm. 22 - lt. 2,5 | Ø 8 5/8" - oz. 84 1/2 |
| Ø cm. 24 - lt. 3,1 | Ø 9 1/2" - oz. 104 7/8 |
| Ø cm. 26 - lt. 3,9 | Ø 10 1/4" - oz. 131 7/8 |
| Ø cm. 28 - lt. 5,1 | Ø 11" - gal. 1 1/4 |

945



mm. 1,2 Legumiera
 Vegetable dish
 Légumière
 Lègumier
 Legumbrera

| | |
|--------------------|-------------------------|
| Ø cm. 14 - lt. 0,6 | Ø 5 1/2" - oz. 20 1/4 |
| Ø cm. 18 - lt. 1,2 | Ø 7" - oz. 40 5/8 |
| Ø cm. 20 - lt. 1,8 | Ø 7 7/8" - oz. 60 7/8 |
| Ø cm. 22 - lt. 2,5 | Ø 8 5/8" - oz. 84 1/2 |
| Ø cm. 24 - lt. 3,1 | Ø 9 1/2" - oz. 104 7/8 |
| Ø cm. 26 - lt. 3,9 | Ø 10 1/4" - oz. 131 7/8 |
| Ø cm. 28 - lt. 5,1 | Ø 11" - gal. 1 1/4 |

946



mm. 1,2 Coperchio per art. 944 - 945
 Lid for art. 944 - 945
 Couvercle pour art. 944 - 945
 Deckel für art. 944 - 945
 Tapa para art. 944 - 945

| | |
|----------|-----------|
| Ø cm. 14 | Ø 5 1/2" |
| Ø cm. 18 | Ø 7" |
| Ø cm. 20 | Ø 7 7/8" |
| Ø cm. 22 | Ø 8 5/8" |
| Ø cm. 24 | Ø 9 1/2" |
| Ø cm. 26 | Ø 10 1/4" |
| Ø cm. 28 | Ø 11" |

936



Cloche trasparente con pomolo
 Transparent cloche with knob
 Cloche transparente
 Transparent Teller cloche
 Tapa transparente

| | |
|----------|----------|
| Ø cm. 12 | Ø 4 3/4" |
| Ø cm. 22 | Ø 8 1/2" |
| Ø cm. 28 | Ø 11" |

940



mm. 1,2 Servizio per caffè macchiato
 Café au lait set
 Service pour café au lait
 Café au lait-Set
 Juego café au lait

| | |
|------------|------------|
| 939 | 939 |
| H cm 18 | H 7 1/8" |
| cl. 90 | oz. 30 1/2 |
| 940 | 940 |
| H cm 18 | H 7 1/8" |
| cl. 97 | oz. 32 7/8 |

940E
 Inserto per art. 940
 Insert for art. 940
 Insért pour art. 940
 Einsatz für Art. 940
 Inserto por art. 940

940E



mm. 1,2 Servizio per caffè macchiato
 5pcs Sugar, milk and coffee set
 Service sucre, lait et café 5 pièces
 Milch-Kaffee-Zucker Set 5-Tlg.
 Juego leche, café y azucar 5 piezas

| | |
|-------------|-----------------|
| H cm 18 | H 7 1/8" |
| cl. 30 (x5) | oz. 10 1/8 (x5) |

94005



943



mm. 1,2 Spargisale, portastecchi
Salt & Pepper
Sel/poivre/porte cure-dents
Salz-Pfeffer-Zahnstocherbehälter
Saleros y pimentero y palillero

H cm. 15 H 5 7/8"
cl. 7,5 (x 2) oz. 2 1/2 (x 2)

942



mm. 1,2 Oliera
Cruet
2 pièces huile-vinaigre
Essig-/Ölgestell
Vinagreras

H cm. 22 H 8 5/8"
cl. 22,5 (x 2) oz. 7 1/2 (x 2)

988



mm 1,2 Portamarmellata a 3 scomparti
Jam pack holder 3 compartment
Porte-confiture 3 comp.
Marmeladgestell 3 Einsätze
Marmeladero 3 comp.

H. cm. 15 H 5 7/8"
cl. 28 (x3) oz. 9 1/2 (x3)

990



mm 1,2 Coppetta con vassoio
Cup and tray
Coupe avec plateau
Schale mit Tablett
Cuenco con bandeja

H cm. 11,5 H 4 1/2"
Ø cm. 10 Ø 3 7/8"

947



Versatore per profumo a goccia
Perfume drops dispenser
Verseur de parfum en gouttes
Tropf-Parfüm Aussteller
Versador de perfume en gotas

Lungh. cm 18,5
Length 7 5/8"

94003



mm. 1,2 Servizio per zucchero 3 e 4 pezzi
Sugar set 3 and 4 pcs.
Service pour sucre 3 et 4 pièces
Sahne-/Zucker-Set 3- und 4-Tlg
Juego azucar 3 y 4 piezas

H cm. 15 H 5 7/8"
cl. 11 (x3) oz. 3 3/4 (x3)
cl. 11 (x4) oz. 3 3/4 (x4)

94004



mm. 1,2 Mini burriera con coperchio
Small butter dish w/lid
Petit beurrier a/couvercle
Mini Butterdose m/Deckel
Platillo para mantequilla
con tapa

cm. 12 x 6 4 3/4" x 2 1/3"
cl. 15 oz. 5 1/8

922



Giotto

257



mm. 1,2 Porta pasticcini con piedistallo
Petit-fours stand with base
Porte-petits-fours avec socle
Petits Fours-Ständer
Porta dulces con pedestal

| | |
|------------|----------|
| Ø cm. 14 | Ø 5 1/2" |
| H cm. 8,7 | H 3 1/2" |
| Ø cm. 20 | Ø 7 7/8" |
| H cm. 13 | H 5 1/8" |
| Ø cm. 28 | Ø 11" |
| H cm. 14,5 | H 5 3/4" |

258



mm. 1,2 Porta pasticcini con piedistallo
Petit-fours stand with legs
Porte-petits-fours avec socle
Mokkaétagère 3 Ebenen
Porta dulces con pedestal

| | |
|----------|-----------|
| Ø cm. 14 | Ø 5 1/2" |
| Ø cm. 20 | Ø 7 7/8" |
| Ø cm. 28 | Ø 11" |
| H cm. 27 | H 10 5/8" |

220



mm. 1,2 Coppa per punch
Punch bowl
Bol à punch
Punch Bowl
Ponchera

| | |
|------------|-----------|
| Ø cm. 38 | Ø 15" |
| H cm. 32,3 | H 12 5/7" |
| lt. 15 | gal. 4 |

255



mm. 1,2 Presentoire
3 misure
3 sizes
3 tailles
3 Größen
3 tamaños

| | |
|----------------|-----------------|
| 25514 | 25514 |
| A Ø cm.14 (x5) | A Ø 5 1/2" (x5) |
| B Ø cm.20 | B Ø 7 7/8" (x5) |
| 25520 | 25520 |
| A Ø cm.20 (x5) | A Ø 7 7/8" (x5) |
| B Ø cm.24 | B Ø 9 1/2" (x5) |
| 25524 | 25524 |
| A Ø cm.24 (x5) | A Ø 9 1/2" (x5) |
| B Ø cm.28 | B Ø 11" |

7070



7070

7071



7072



7073



7073

| | | | | | | | |
|---|----------------------|--|------------------------|---|------------------------|---|------------------------|
| Candelabro bugia Candlestick Chandelier Leuchter mit Kerze Candelabro | H cm. 13 H 5 1/8" | Candelabro a 1 fiamma Candlestick Chandelier Leuchter 1-flammig Candelabro | H cm. 23,6 H 9 1/4" | Candelabro a 3 fiamme Candelabra, 3 arms Chandelier 3 flammes Leuchter 3-flammig Candelabro 3 luces | H cm. 23,6 H 9 1/4" | Candelabro a 5 fiamme Candelabra, 5 arms Chandelier 5 flammes Leuchter 5-flammig Candelabro 5 luces | H cm. 23,6 H 9 1/4" |
|---|----------------------|--|------------------------|---|------------------------|---|------------------------|

141



mm. 1,2 NOVECENTO
Vassoio
Tray
Plateau
Tablett
Bandeja

| | |
|-------------|-------------------|
| cm. 30 x 21 | 11 3/4" x 8 1/4" |
| cm. 35 x 24 | 13 3/4" x 9 1/2" |
| cm. 40 x 27 | 15 3/4" x 10 5/8" |
| cm. 45 x 31 | 17 3/4" x 12 1/4" |
| cm. 50 x 34 | 19 5/8" x 13 3/8" |
| cm. 60 x 42 | 23 5/8" x 16 1/2" |
| cm. 80 x 54 | 31 1/2" x 21 1/4" |

144



mm. 1,2 NOVECENTO
Vassoio con maniglie
Tray with handles
Plateau avec anses
Tablett mit Griffen
Bandeja con asas

| | |
|-------------|-------------------|
| cm. 40 x 27 | 15 3/4" x 10 5/8" |
| cm. 45 x 31 | 17 3/4" x 12 1/4" |
| cm. 50 x 34 | 19 5/8" x 13 3/8" |
| cm. 60 x 42 | 23 5/8" x 16 1/2" |
| cm. 80 x 54 | 31 1/2" x 21 1/4" |

141GN



mm. 1,2 NOVECENTO
Gastronorm

| | |
|---------------|-------------------|
| 1/1 GN | 1/1 GN |
| cm. 53 x 32,5 | 20 7/8" x 12 2/3" |

| | |
|-------------|-------------------|
| 2/1 GN2 | 2/1 GN2 |
| cm. 65 x 53 | 25 5/8" x 20 7/8" |

144GN



mm. 1,2 NOVECENTO
Gastronorm con maniglie
Gastronorm with handles
Gastronorm avec anses
Gastronorm mit Griffen
Gastronorm con asas

1/1 GN
cm. 53 x 32,5
20 7/8" x 12 2/3"

2/1 GN2
cm. 65 x 53
25 5/8" x 20 7/8"

146GN



mm. 1,2 NOVECENTO
Gastronorm

| | |
|---------------|-------------------|
| 1/1 GN | 1/1 GN |
| cm. 53 x 32,5 | 20 7/8" x 12 2/3" |

| | |
|-------------|-------------------|
| 2/1 GN2 | 2/1 GN2 |
| cm. 65 x 53 | 25 5/8" x 20 7/8" |

146



mm. 1,2 Vassoio con maniglia sovrapponibile
Tray with stackable handles
Plateau avec anses empilables
Tablett mit stapelbaren Griffen
Bandeja con asas empilables

| | |
|-------------|-------------------|
| cm. 30 x 21 | 11 3/4" x 8 1/4" |
| cm. 35 x 24 | 13 3/4" x 9 1/2" |
| cm. 40 x 27 | 15 3/4" x 10 5/8" |
| cm. 45 x 31 | 17 3/4" x 12 1/4" |
| cm. 50 x 34 | 19 5/8" x 13 3/8" |
| cm. 60 x 42 | 23 5/8" x 16 1/2" |
| cm. 80 x 54 | 31 1/2" x 21 1/4" |

137



mm. 1,2 Vassoio quadro NOVECENTO cm. 60 x 60 23 5/8" x 23 5/8"
 Square tray »
 Plateau carré »
 Tablett, quadratisch »
 Bandeja cuadrada »

256



mm. 1,2 Vassoio rotondo GIOTTO Ø cm. 27 Ø 10 5/8"
 Round tray » Ø cm. 35 Ø 13 3/4"
 Plateau rond » Ø cm. 40 Ø 15 3/4"
 Tablett rund »
 Bandeja redonda »

138



mm. 1,2 Vassoio quadro con maniglie NOVECENTO cm. 60 x 60 23 5/8"x23 5/8"
 Square tray with handles »
 Plateau carré avec anses »
 Tablett, quadratisch mit Griffen »
 Bandeja cuadrada con asas »

AIRLINES

140



mm. 1,2 Vassoio per compagnie aeree 200140 ATLAS
 Airlines tray for on board service cm. 38,5 x 27,5
 Ideal for aircraft and corporates jets 15 1/8" x 10 4/5"
 Chariot de service 200140K KSSU
 Bordservice -Tablett f. Airlines cm. 40,4 x 27,9
 Bandeja de servicio para comp. aéreas 15 7/8" x 11"

139



mm. 1,2 Vassoio quadr.c/man.sovrappon. cm. 60 x 60 23 5/8" x 23 5/8"
 Square tray w/stackable handles
 Plateau carré a/anses empliabiles
 Tablett quadr.m/stapelb. Griffen
 Bandeja cuadrada c/asas empil.

250

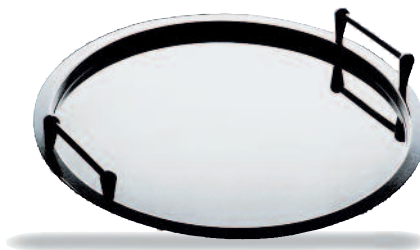

mm. 1,2 Vassoio con maniglia sovrapponibile Ø cm. 35 Ø 13 3/4"
 Tray with stackable handles Ø cm. 40 Ø 15 3/4"
 Plateau avec anses empliabiles
 Tablett mit stapelbaren Griffen
 Bandeja con asas empilables

295



mm. 1,2 Vassoio tondo con piedistallo Ø cm. 35 Ø 13 3/4"
 Round tray with base H cm. 12,5 H 4 7/8"
 Plateau rond avec socle
 Obstschale, rund auf Fuß
 Bandeja redonda con pedestal

297



mm. 1,2 Vassoio ovale con piedistallo cm. 45 x 30 17 3/4" x 11 3/4"
 Oval tray with base H cm. 12,5 H 4 7/8"
 Plateau oval avec socle
 Obstschale, oval auf Fuß
 Bandeja oval con pedestal

296



mm. 1,2 Vassoio rettang. con piedistallo cm. 45 x 30 17 3/4" x 11 3/4"
 Rectangular tray with base H cm. 12,5 H 4 7/8"
 Plateau rectang. avec socle
 Tablett, rechteckig auf Fuß
 Bandeja rectang. con pedestal

298



mm. 1,2 Piatto torta con piedistallo Ø cm. 40 Ø 15 3/4"
 Cakes plate with base H cm. 9,5 H 3 3/4"
 Plat à tarte avec socle
 Kuchenplatte auf Fuß
 Bandeja tarta con pedestal

287



mm. 2,0 Vassoio rettangolare per buffet cm. 30x21 11 3/4" x 8 1/4"
 Rectangular Tray for buffet cm. 40x27 15 3/4" x 10 5/8"
 Plateau rectangulaire pour buffet cm. 50x34 19 5/8" x 13 3/8"
 Buffet -Tablett, rechteckig cm. 60x42 23 5/8" x 16 1/8"
 Bandeja rectangular para entremes

288



mm. 2,0 Vassoio tondo per buffet Ø cm. 30 Ø 11 3/4"
 Round Tray for buffet Ø cm. 40 Ø 15 3/4"
 Plateau rond pour buffet Ø cm. 50 Ø 19 5/8"
 Buffet-Tablett rund Ø cm. 60 Ø 23 5/8"
 Bandeja redonda para entremes

7004A



mm. 0,8 Alzata per pesce crudo
Marinated fish holder
Serviteur à poisson crude
Etagere für marinierten Fisch
Porta pescado

Ø cm. 34 Ø 13 3/4"
Ø cm. 41 Ø 16 1/8"
H cm. 55 H 21 5/8"

7004B



mm. 1,2 Alzata per pesce crudo
Marinated fish holder
Serviteur à poisson crude
Etagere für marinierten Fisch
Porta pescado

Ø cm. 22 Ø 8 5/8"
Ø cm. 34 Ø 13 3/8"
H cm. 38 H 15"

7002B



mm. 1,2 Alzata portafrutta
Fruit holder
Serviteur
Etagere
Frutero

NOVECENTO »
»
»
»

cm. 35x24 13 3/4" x 9 1/2"
cm. 45x31 17 3/4" x 12 1/4"
cm. 60x42 23 5/8" x 16 1/2"
H cm. 70 H 27 5/8"

7001B



mm. 1,2 Alzata portafrutta
Fruit holder
Serviteur
Etagere
Frutero

GIOTTO »
»
»
»

Ø cm. 27 Ø 10 5/8"
Ø cm. 35 Ø 13 3/4"
Ø cm. 40 Ø 15 3/4"
H cm. 70 H 27 5/8"

67301



67304

mm. 1,2 Portaggiaccio termico con coperchio Ø cm 14 Ø 5 1/2"
 Insulated ice-bucket with lid H cm 13,5 H 5 1/9"
 Seau à glaçons thermique avec couvercle lt. 0,70 oz. 23 2/3
 Isolier-Eisgefäß, mit Deckel Ø cm 24 Ø 9 1/2"
 Cubitera hielo térmica con tapa H cm 23 H 9"
 lt. 2,75 oz. 93

668



669

mm. 1,2 Secchiello spumante e ghiaccio Ø cm 24 Ø 9 1/2"
 Sparkling wine cooler / Ice bucket H cm 23 H 9"
 Seau à champagne et à glaçons lt. 2,75 oz. 93
 Wein- Sektkühler / Eisgefäß Ø cm 14 Ø 5 2/3"
 Cubo para champany y para hielo H cm 13,5 H 5 1/9"
 lt. 0,70 oz. 23 2/3

666E



mm. 1,2 Colonna portasecchiello spumante H cm. 67,5 H 26 5/8"
 Wine cooler stand
 Pied pour seau à champagne
 Weinkühlerständer
 Columna porta cubo champany

686



mm. 1,2 Champagnera 5 bott. c/pied. Ø cm. 40 Ø 15 3/4"
 Giant Champagne bucket 5 bot. H cm. 38,5 H 15 1/6"
 Seau à champagne p/5 bout. lt. 15 gal. 4
 Champagner Bowl 5 Fläsche
 Cubo de champagne p/5 bot.

685



mm. 1,2 Champagnera 5 bott. s/pied. Ø cm. 40 Ø 15 3/4"
 Giant Champagne bucket 5 bot. H cm. 21,8 H 8 3/5"
 Seau à champagne p/5 bout. lt. 15 gal. 4
 Champagner Bowl 5 Fläsche
 Cubo de champagne p/5 bot.

666I



mm. 1,2 Colonna portabottiglie spumante H cm. 78 H 30 5/7"
 Wine cooler stand
 Pied pour seau à champagne
 Weinkühlerständer
 Columna porta cubo champany

674



mm. 1,2 Spumantiera termica 5 bott. s/pied. Ø cm. 40 Ø 15 3/4"
 Giant insulated Champagne bucket 5b. H cm. 21,8 H 8 3/5"
 Seau à champagne thermique p/5 bou. lt. 15 gal. 4
 Isolier Champagner Bowl 5 Fläsche
 Cubo térmico para champagne p/5 bot.

265



mm. 1,2 Vassoio per pasticceria
Patisserie tray
Plateau pour patisserie
Patisserie Tablett
Bandeja para pasteleria

cm. 24,5 x 17 9 5/8" x 6 3/4"
cm. 30 x 21 11 3/4" x 8 1/4"
cm. 34 x 24 13 3/8" x 9 1/2"

NEW

207



con piedistallo
with foot
avec socle
mit Fuss
con pies

cm. 24,5 x 17 9 5/8" x 6 3/4"
cm. 30 x 21 11 3/4" x 8 1/4"
cm. 34 x 24 13 3/8" x 9 1/2"
H cm. 13 H 5 1/9"

516



516



51610



518

mm. 1,2 Portabustine da zucchero
Sugar packet holder
Pot à sucre
Zuckerstangengefäß
Azucarera

516
cm. 10 x 7
H cm. 3

516
4" x 2 3/4"
H 1 1/8"

51610
cm. 10 x 5
H cm. 4,5

51610
4" x 2"
H 1 3/4"

Cesto portapane, porta agrumi
Basket for bread/ for fruit
Panier / Porte agrumes
Brot-/Früchtekorb
Cesto por pan/ por cítricos
mm. 1,2

cm. 33 x 26
H cm. 20

13" x 10 1/5"
H 7 7/8"

704

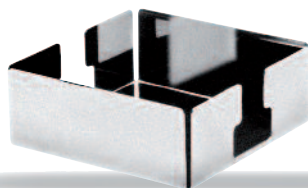

Portatovaglioli
Napkin holder
Distributeur de serviettes
Serviettenhalter
Portaservilletas
mm. 1,2

cm. 13 x 13

5 1/9" x 5 1/9"

270



Portatovaglioli
Napkin holder
Distributeur de serviettes
Serviettenhalter
Portaservilletas
mm. 1,2

cm. 12,5 x 4,5
H cm. 7

5" x 1 7/8"
H 2 3/4"

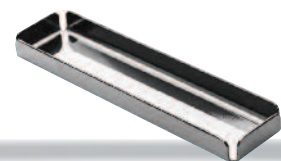

Portastuzzicadenti
Toothpick container
Porte-cure-dents
Zahnstocherbehälter
Porta-palillos
mm. 1,2

cm. 11 x 3

4 1/3" x 1 1/5"

424

206

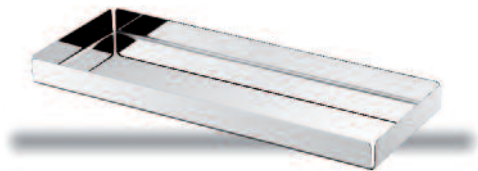

mm. 1,2 Vassoio per pasticceria cm. 26 x 12 10¹/₄" x 4³/₄"
 Patisserie tray cm. 60 x 12 23³/₅" x 10¹/₅"
 Plateau pour patisserie
 Patisserie Tablett
 Bandeja para pasteleria

205



con piedistallo cm. 26 x 12
 with foot cm. 60 x 12
 avec socle H cm. 13
 mit Fuss 10¹/₄" x 4³/₄"
 con pies 23³/₅" x 10¹/₅"
 H 5¹/₉"

153

NEW



mm. 1,2 Vassoio portabicchieri impilabile cm. 38 x 27
 Stackable tray for glasses
 Plateau porte verres empilable
 Stapelbare Gläserträger Tablett 15" x 10⁵/₈"
 Bandeja porta vasos impilable

505

NEW



mm. 1,2 Vassoio per carrelli cm. 56 x 40 16" x 22"
 Tray for rack trolley
 Plateau pour chariot porte-plateau
 Tablett für Rack
 Bandeja para estante

150

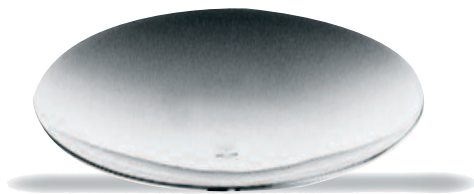

mm. 1,2 Platto concavo Ø cm. 14 Ø 5¹/₂"
 Crescent plate Ø cm. 18 Ø 7"
 Plateau concave Ø cm. 20 Ø 7⁷/₈"
 Konkave Platte Ø cm. 22 Ø 8⁵/₈"
 Plato concavo Ø cm. 24 Ø 9¹/₂"
 Ø cm. 26 Ø 10¹/₄"
 Ø cm. 28 Ø 11"

154

NEW



mm. 1,2 Cestino per pane Ø cm. 20 Ø 7⁷/₈"
 Bread basket Lt. 2 oz. 67³/₅"
 Corbeille pour pan
 Brotschale
 Cuenco para pan

284



| | | | |
|---------|------------------------------------|-----------|---|
| mm. 1,2 | Vassoio rettangolare da servizio | cm. 30x21 | 11 ³ / ₄ " x 8 ¹ / ₄ " |
| | Rectangular service tray | cm. 35x24 | 13 ³ / ₄ " x 9 ¹ / ₂ " |
| | Plateau rectangulaire pour service | cm. 40x27 | 15 ³ / ₄ " x 10 ⁵ / ₈ " |
| | Tablett rechteckig für Service | cm. 45x31 | 17 ³ / ₄ " x 12 ¹ / ₄ " |
| | Bandeja rectangular da servicio | cm. 50x34 | 19 ⁵ / ₈ " x 13 ³ / ₈ " |
| | | cm. 60x42 | 23 ⁵ / ₈ " x 16 ¹ / ₈ " |

283



| | | | |
|---------|------------------------------|----------|------------------------------------|
| mm. 1,2 | Vassoio tondo da servizio | Ø cm. 27 | Ø 10 ⁵ / ₈ " |
| | Round service tray | Ø cm. 35 | Ø 13 ³ / ₄ " |
| | Plateau rond pour service | Ø cm. 40 | Ø 15 ³ / ₄ " |
| | Tablett rund für Service | | |
| | Bandeja redonda por servicio | | |

415



| | | |
|---------|--|-----------------------------------|
| mm. 1,2 | Cloche per servizio, mantieni calore | Ø cm. 20 |
| | Cloche for service, heat keeper | |
| | Cloche pour service, mainteneur de chaleur | |
| | Service-Cloche, Wärmepflege | Ø 7 ⁷ / ₈ " |
| | Cloche de servicio, mantenedor de calor. | |



225



| | | |
|-------------------------------|----------|-----------------------------------|
| Cloche trasparente con pomolo | Ø cm. 12 | Ø 4 ³ / ₄ " |
| Transparent cloche with knob | Ø cm. 22 | Ø 8 ⁵ / ₈ " |
| Cloche transparente | Ø cm. 28 | Ø 11" |
| Transparente Teller cloche | | |
| Tapa transparente | | |

155

NEW



| | | | |
|---------|-----------------|---------|-----------------------------------|
| mm. 1,2 | Porta noccioli | Ø cm. 6 | Ø 2 ² / ₅ " |
| | Olive seeds jar | H cm. 5 | H 2" |
| | Porte noyaux | cl. 5 | oz. 1 ³ / ₄ |
| | Aderhalter | | |
| | Porta granos | | |

721



mm. 1,2
Coppa termica con cloche
Insulated cup with cloche
Coupe thermique avec cloche
Isolier-Eisfruchtbecher mit Deckel
Copa térmica con tapa

Ø cm. 8,5 Ø 3 1/3"
cl. 15 oz. 6

259



mm. 1,2
Ciotola con base
Bowl with base
Bol avec socle
Obstschale auf Fuss
Cuenco con pedestal

Ø cm. 20
H cm. 14,3
lt. 2,1

Ø 5 2/3"
H 7 7/8"
gal. 1/2

Ø cm. 28
H cm. 18,3
lt. 5,7

Ø 11"
H 7 1/5"
gal. 1 1/2

864



GALA
Cestino semitraforato
Half fretworked basket
Corbeille demi-ajouré
Schale, halbgelocht
Frutero semiperforado

Ø cm. 22 Ø 8 5/8"
H cm. 5,7 H 2 1/4"
cl. 150 oz. 50 3/4

mm. 0,8

834



GALA
Cestino portafrutta
Round basket
Corbeille ronde
Schale, rund
Frutero redondo

Ø cm. 22 Ø 8 5/8"
H cm. 5,7 H 2 1/4"
cl. 150 oz. 50 3/4

mm. 0,8

Ø cm. 34 Ø 13 3/8"
H cm. 5,7 H 2 1/4"
cl. 500 gal. 1 1/3



GALA
Cestino traforato
Fretworked basket
Corbeille ajouré
Schale, gelocht
Frutero perforado

Ø cm. 22 Ø 8 5/8"
H cm. 5,7 H 2 1/4"
cl. 150 oz. 50 3/4

mm. 0,8

863

254



Supporto per informazioni o menu
Menu / Card holder
Porte nom numéro de table
Karten / Speisekartenhalter
Porta informaciones o menu

Ø cm. 6 Ø 2 1/2"
H cm. 9 H 3 1/2"

Portamenù
Menù holder
Porte-menu
Menükartenhalter
Portamenù



907

cm. 21 x 13,5 8 5/8" x 5 3/8"
H cm 29,7 H 11 3/4"



994

Portanumero
Table number stand
Numbers etched to order
Porte numéro de table
Tischnummernständer
Porta numero de mesa

A
Ø cm 8,3
H cm 47,3

B
Ø cm 8,3
H cm 24

A
Ø 3 1/4"
H 18 5/8"

B
Ø 3 1/4"
H 9 1/2"

712



mm. 1,2 Chillcup per burro e caviale con base
Chillcup for butter and caviar with base
Chillcup pour beurre et caviar avec socle
Chillcup für Butter und Kaviar mit Fuß
Chillcup para mantequilla y caviar
con pedestal

713



Chillcup per burro
Chillcup for butter
Chillcup pour beurre
Chillcup für Butter
Chillcup para mantequilla

Ø cm. 12
cl. 15
Ø 4 3/4"
oz. 5 1/8



Servizio per caviale
Caviar set
Service à caviar complet
Kaviarschale
Servicio para caviar

Ø cm. 18
cl. 15
Ø 7 1/8"
oz. 5 1/8

301



301A

301C

301B

| | | |
|---|-----------------|---------------|
| mm. 0,8 Chillcup per cocktail di gamberetti Supreme bowl, complete Coupe à crevettes Chillcup für Hummercocktail Chillcup para coctél mariscos | 301 Ø cm. 15 | Ø 5 7/8" |
| | cl. 17,5 | oz. 6 |
| | 301A Ø cm. 15 | 301A Ø 5 7/8" |
| | 301B Ø cm. 13,5 | 301B Ø 5 3/8" |
| | 301C Ø cm. 9,5 | 301C Ø 3 3/4" |
| | cl. 17,5 | oz. 6 |

725

722



| | | |
|---|----------|-----------|
| mm. 0,6 Piatino per coppa gelato Under liner for ice-cream bowl Petit plat soucoupe glace Unterteller für Eisschale Platillo melado | Ø cm. 12 | Ø cm. 8,5 |
| | | cl. 15 |
| | Ø 4 3/4" | Ø 3 3/4" |
| | | oz. 5 1/8 |

| | | |
|--|-----------|----------|
| mm. 1,2 Coppa per gelato Ice-cream bowl Coupe à glace Eisschale Copa helado | Ø cm. 9,5 | Ø 3 3/4" |
| | cl. 17 | oz. 6 |



723

498



mm. 1,2 Completo oliera con spargisale a 5 H cm. 22 H 8 5/8"
Cruet and salt cellar set 5 pcs. cl. 22,5 (x 2) oz. 7 1/2 (x 2)
Service huile-vinaigre 5 pcs. cl. 7,5 (x 3) oz. 2 1/2 (x 3)
Essig-/Ölgestell 5-Tlg.
Convoy vinagreras con saleros 5 pzs

507



mm. 1,2 Completo oliera con spargisale a 4 H cm. 22 H 8 5/8"
Cruet and salt cellar set 4 pcs. cl. 22,5 (x 2) oz. 7 1/2 (x 2)
Service huile-vinaigre 4 pcs. cl. 7,5 (x 2) oz. 2 1/2 (x 2)
Essig-/Ölgestell 4-Tlg.
Convoy vinagreras con saleros 4 pzs

506



430350

mm. 1,2 Oliera GALA H cm. 22 H 8 5/8"
Cruet » cl. 22,5 (x 2) oz. 7 1/2 (x 2)
2 pièces huile-vinaigre »
Essig-/Ölgestell »
Vinagreras »

525



mm. 1,2 Formaggera GALA cl. 20 oz. 6 3/4
Parmesan cheese basin »
Fromagère »
Käsedose »
Quesera-Azucarero »

513



430510SS 430510ST

mm. 1,2 Spargisale, portastecchi GALA H cm. 15
Salt-cellar with toothpick container » cl. 7,5 (x 3)
Sel-poivre/porte cure-dents »
Salz-Pfeffer-Zahnstocherbehälter » H 5 7/8"
Saleros y pimentero y palillero » oz. 2 1/2 (x 3)

702



mm. 1,2 Mini burriera con coperchio cm. 12 x 6 4 3/4" x 2 1/3"
Small butter dish w/lid cl. 15 oz. 5 1/8
Petit beurrier a/couvercle
Mini Butterdose m/Deckel
Platillo para mantequilla con tapa



Dry Aged

DRY AGED



620

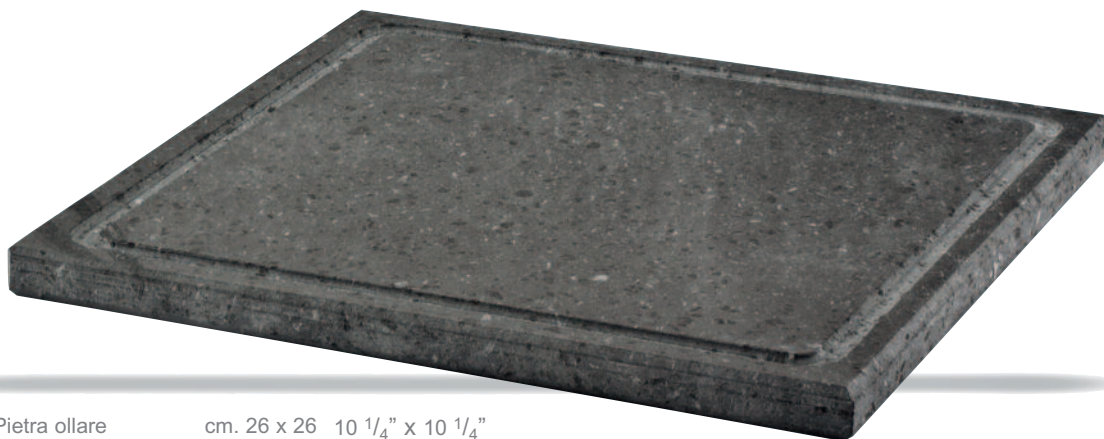

Pietra ollare
Soapstone
Ardoise
Speckstein
Pizarra

cm. 26 x 26 10 1/4" x 10 1/4"

700



H cm 10 H 4"
cl. 35 oz. 11 7/8

mm. 1,2 Portapatatine fritte
French fry holder for table
Porte pommes frites pour table
Kartoffelbehälter für Tisch
Porta patatas fritas por mesa

260



Ø cm 10 H 3 3/4"
H cm 9,5 Ø 3 7/8"

289



H cm. 10 H 3 7/8"
Ø cm. 6 Ø 2"

902



H cm 8 H 3 1/4"
Ø cm 7 Ø 2 3/4"

282



mm. 1,2 Braciere con pietre naturali Ø cm. 15 Ø 5 7/8"
Table grill with natural stones Ø cm. 22 Ø 8 5/8"
Brasero avec pierres naturelles Ø cm. 32 Ø 12 5/8"
Feuerschale mit Natursteine
Hoguera c/piedras naturales

572



Ampolla cl. 20 oz. 6 3/4
Cruet cl. 34 oz. 11 1/2
Huilliere cl. 62 oz. 21
Öl-/Essigflaschen
mit Spender
Vinagrera

1136

1136

10001136



10001136

UNI

Coltello bistecca cm. 21,3 8 1/4"

Steak knife

Couteau entrecôte

Steakmesser

Cuchillo bistek

10101136
10231136



10101136

NORMA

10231136

BOHEME

Coltello bistecca cm. 23 9 1/8"

Steak knife

Couteau entrecôte

Steakmesser

Cuchillo bistek

10141136
1020B1136
10341136



10141136

ROMA

1020B1136

10341136

NATURA

Coltello bistecca cm. 22,7 8 7/8"

Steak knife

Couteau entrecôte

Steakmesser

Cuchillo bistek

1144

1144

10001144



Coltello bistecca americano

cm. 25 9 5/8"

American steak knife

Couteau entrecôte américain

Amerikanisches Steakmesser

Cuchillo bistek americano

28215



mm. 1,2 Braciére con pietre naturali
Table grill with natural stones
Brasero avec pierres naturelles
Feuerschale mit Natursteine
Hoguera c/piedras naturales

Ø cm. 15 Ø 5 7/8"

28222



mm. 1,2 Braciére con pietre naturali
Table grill with natural stones
Brasero avec pierres naturelles
Feuerschale mit Natursteine
Hoguera c/piedras naturales

Ø cm. 22 Ø 8 5/8"

28232



mm. 1,2 Braciére con pietre naturali
Table grill with natural stones
Brasero avec pierres naturelles
Feuerschale mit Natursteine
Hoguera c/piedras naturales

Ø cm. 32 Ø 12 5/8"



A differenza del carbone, le pietre laviche rilasciano il calore molto lentamente e possono mantenere il cibo in cottura, senza cuocerlo eccessivamente

Unlike charcoal, lava stones release the heat very slowly and can cook food without over-cooking.

NEW

DRY AGED

NEW

78125



mm. 1,2 Sauteuse

cm. 25 9 5/8"

78130



mm. 1,2 Sauteuse

cm. 30 11 3/4"

78135



mm. 1,2 Sauteuse

cm. 35 13 3/4"

78140



mm. 1,2 Sauteuse

cm. 40 15 3/4"



574



Antipastiera quadra in vetro cm. 24,5 x 24,5 9⁵/₈" x 9⁵/₈"
 Hors d'oeuvre tray in glass
 Plat à hors d'oeuvre en verre
 Vorspeisenplatte aus Glas
 Entremesera en vidrio

575



Piatto quadro in vetro cm. 24,5 x 24,5 9⁵/₈" x 9⁵/₈"
 Square plate in glass
 Plateau carré en verre
 Platte, viereckig, aus Glas
 Plato cuadrado en vidrio

582



Supporto per cm. 43 x 14 16⁷/₈" x 5¹/₂"
 Multifunction stand for
 Support multi-usages pour
 Schalenhalter
 Soporte multiuso para

581



Supporto per cm. 36 x 14 14¹/₈" x 5¹/₂"
 Multifunction stand for
 Support multi-usages pour
 Schalenhalter
 Soporte multiuso para

570



mm. 1,2 UNO
 Cremiera
 Cream jug
 Crémier
 Sahnegießer
 Jarrita lechera
 Ø cm. 6 Ø 2³/₈"
 H cm. 8,8 H 3¹/₂"
 cl. 16 oz 5³/₈

594



mm. 1,2 UNO
 Cremiera con piedistallo
 Cream jug with base
 Crémier avec socle
 Sahnegießer auf Fuss
 Jarrita lechera con pedestal
 Ø cm. 6 Ø 2³/₈"
 H cm. 9 H 3¹/₂"
 cl. 16 oz 5³/₈

576



Servizio per pinzimonio in vetro Ø cm. 28 Ø 11"
 Salad set in glas H cm. 8 H 3 1/8"
 Service pour salade en verre cl. 300 oz. 101 1/2
 Service für Salat aus Glas
 Servicio para ensalada en vidrio

290576



Servizio per pinzimonio Ø cm. 28 Ø 11"
 Set for salad serving cl. 300 oz. 101 1/2
 Service à crudités
 Set "Salatdressing"
 Servicio para ensaladas

Ciambella termica per supporto Milleusi. La ciambella termica è usata per mantenere a lungo le temperature calde o fredde. Nel primo caso va riscaldata in forno ad una temperatura variabile tra i 160° C ed i 250° C, nel secondo caso va conservata in freezer a -14° C. In queste condizioni e in grado di mantenere la temperatura desiderata (da -5° C a +50° C) per un periodo che varia dai 20 ai 30 minuti

Thermal serving unit for multifunction stand.

The thermal serving unit is used to maintain heat or cold. In the first case, it must be heated in an oven at 160° C (+320° F) -250° C (+482° F). In the second case in a Freezer at -14° C (-57° F). In these conditions it is able to maintain the food either hot or cold for a period between 20 and 30 minutes at the desired temperature (from -5° C (-41° F) to +50° C (+122° F)).

Disque thermique pour support multi-usages. Le disque thermique est utilisé pour maintenir la chaleur ou le froid. Dans un cas, le disque est préchauffé dans le four à une température variant de 160° C a 250° C. Dans un second cas, le disque peut être refroidi jusqu'à -14° C. Dans ces conditions, le disque est en mesure de maintenir la chaleur ou la fraîcheur pendant un temp variable de 20 a 30 minutes, a la température voulue (de -5° C a +50° C).



583
 Ciambella termica per supporti
 Thermal serving unit for stands
 Disque thermique pour support
 Thermische Ringröhre für Hälter
 Bobina térmica para soportes
 Ø cm. 12 - Ø 4 3/4"

Der Warmhalteteller mit Thermikelement dient zum Servieren von warm- oder kaltzuhaltenden Speisen, also sowohl zur Speicherung von Wärme als auch von Kälte. Zum Warmhalten erhitzt man das runde Thermikelement im Ofen auf 160 bis 250° C. Zum Kalthalten kühlt man im Gefrierfach das runde Thermikelement auf -14° C ab. Derart eingefügt in die Vertiefung des Warmhaltetellers kann man Speisen bis zu 30 min bei einer gewünschten Temperatur zwischen -5° C und +50° C kalt bzw. warm halten.

Bobina térmica para soporte multiuso. La bobina térmica puede ser utilizada para mantener el calor o el frío. En el primer caso, se calienta en el horno a una temperatura variable entre 160° C y 250° C; en el segundo, se mete en un congelador a -14° C. En estas condiciones, es capaz de mantener los alimentos calientes o fríos durante un periodo que oscila entre 20 y 30 minutos a la temperatura deseada (de -5° C a +50° C).



582

580



Pirofila ovale in fine china cm. 37 x 24 14 5/8" x 9 3/8"
 Fine china oval bowl cl. 300 oz. 101 1/2
 Plat oval en porcelaine à feu
 Auflaufform, oval aus Porzellan
 Pirophila oval en porcelana

579



Lasagnera in fine china cm. 34,5 x 24,5 13 5/8" x 9 5/8"
 Fine china Lasagne's bowl cl. 300 oz. 101 1/2
 Plat rectangulaire en porcelaine à feu
 Auflaufform, quadr. aus Porzellan
 Fuente para Lasagne en porcelana



Room Service

272



mm. 0,8 Piatto termico con copripiatto e ciambella termica
 Insulated plate with cover and thermal serving unit
 Plat thermique avec couvre-plat et disque thermique
 Warmhalteteller mit Tellerglocke und Thermikelement
 Plato térmico con cubre platos y bobina térmica

Ø cm. 28,5
 Ø cm. 30,5
 Ø cm. 33,7

Ø 11¹/₄"
 Ø 12"
 Ø 13¹/₄"

273



mm. 0,8 Piatto termico con cloche e ciambella termica
 Insulated plate with cloche and thermal serving unit
 Plat thermique avec cloche et disque thermique
 Warmhalteteller mit Tellerglocke und Thermikelement
 Plato térmico con tapadera y bobina térmica

Ø cm. 28,5
 Ø cm. 30,5
 Ø cm. 33,7

Ø 11¹/₄"
 Ø 12"
 Ø 13¹/₄"

A Ø cm. 28 - 30 - 33
 Ø 11" - 11³/₄" - 13¹/₄"

B Ø cm. 28 - 30 - 33
 Ø 11" - 11³/₄" - 13¹/₄"



C Ø cm. 12
 Ø 4³/₄"

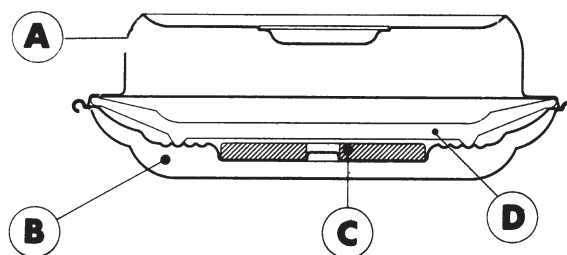

La ciambella termica © è usata per mantenere a lungo le temperature calde o fredde.

Nel primo caso va riscaldata in forno ad una temperatura variabile tra i 60°C ed i 150°C; nel secondo caso in Freezer a -14°C. In queste condizioni è in grado di mantenere la temperatura desiderata (da -5°C a +50°C) per un periodo che varia dai 20 ai 30 minuti.

The Thermal serving unit © maintains food at hot or cold temperatures for about 30 minutes.

The disk can be placed in an oven at 140°C (302°F) or in a freezer at -14°C (-57°F).

Le disque thermique © est utilisé pour maintenir la chaleur ou le froid. Dans un cas, le disque est préchauffé dans le four à une température variant de 60°C à 150°C. Dans un second cas, le disque peut être refroidi jusqu'à -14°C. Dans ces conditions, le disque est en mesure de maintenir la chaleur ou la fraîcheur pendant un temps variable de 20 à 30 minutes, à la température voulue (de -5°C à -50°C).

Der Warmhalteteller mit Thermikelement dient zum Servieren von warm- oder kalzuhaltenden Speisen, also sowohl zur Speicherung von Wärme als auch von Kälte. Zum Warmhalten erhitzt man das runde Thermikelement im Ofen auf 60° bis 150° C. Zum Kalthalten kühlt man im Gefrierfach das runde Thermikelement auf -14° C ab. Derart eingefügt in die die Vertiefung des Warmhaltetellers kann man Speisen bis zu 30 min bei einer gewünschten Temperatur zwischen -5° C und +50° C kalt bzw. warm halten.

La bobina térmica © puede ser utilizada para mantener el calor o el frío. En el primer caso se calienta en el horno a una temperatura variable entre 60°C y 150°C; en el segundo, se mete en un congelador a -14°C. En estas condiciones es capaz de mantener los alimentos calientes o fríos durante un periodo que oscila entre 20 y 30 minutos a la temperatura deseada (de -5° C a +50° C).

Una rivoluzionaria soluzione per un servizio ai piani di alta classe, nella massima sicurezza anti-incendio, evitando l'uso di fiamme o fornelli.

A revolutionary solution for room service, eliminating the need of fuel or electric wires.

C'est une solution révolutionnaire pour un Service à l'Étage de qualité en conformité avec les règles de sûreté anti-incendie et en évitant l'usage de flammes ou feux ouverts.

Dies ist eine revolutionäre Lösung für den hohen Anspruch an excellenten Zimmerservice. Man vermeidet dabei den Gebrauch von offenem Feuer oder elektrischen Platten und vermeidet Konflikte mit den Brandschutzrichtlinien der jeweiligen Länder

Es una solución revolucionaria para un servicio de habitación de alta calidad que respeta las normas de seguridad contra incendios, pues evita el peligro de l'uso de llamas y hornillos encendidos.

425
Tiffin' box

H cm. 21,3
cm. 24,5 x 25,3

H 8 2/5"
9 5/8" x 10"

Colori personalizzati a disposizione
Custom colors available
Couleurs personnalisées
Benutzerdefinierte Farben verfügbar
Colores personalizados disponible



NEW

ROOM SERVICE

NEW

425



153



153

mm. 1,2 Vassoio per carrelli
Tray for rack trolley
Plateau pour chariot porte-plateau
Tablett für Rack
Bandeja para estante

cm. 56 x 40 22" x 16"

429

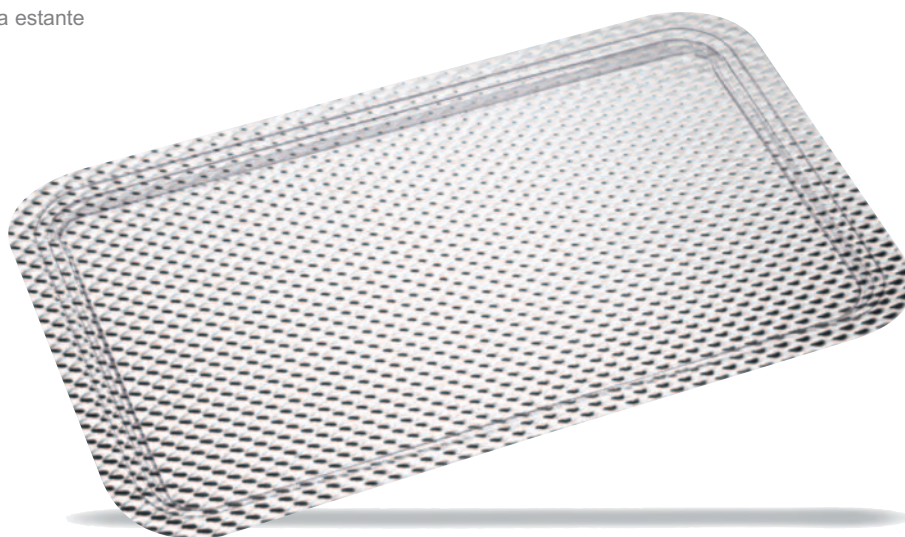

429

mm. 1,0 Vassoio per carrelli
Tray for rack trolley
Plateau pour chariot porte-plateau
Tablett für Rack
Bandeja para estante

cm. 63 x 45 24 11/16" x 17 3/4"

429

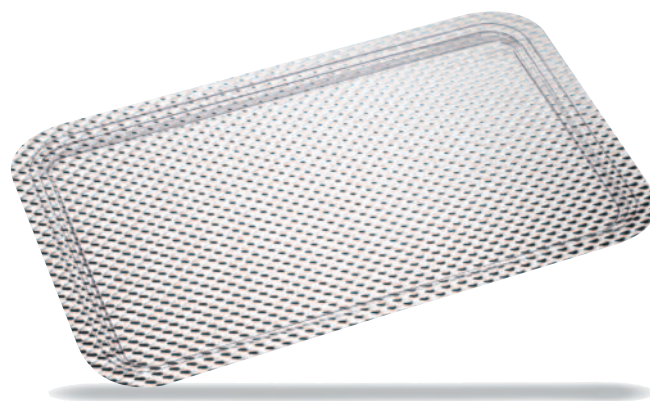

429

mm. 1,0 Vassoio per carrelli
Tray for rack trolley
Plateau pour chariot porte-plateau
Tablett für Rack
Bandeja para estante

cm. 45 x 31 17 3/4" x 12 1/4"





Menu & Banquet

305

316



mm. 1,2 Vassoio rettangolare
Rectangular tray
Plateau rectangulaire
Tablett, rechteckig
Bandeja rectangular
cm. 40,5 x 27,5 15⁷/₈" x 10³/₄"
cm. 45 x 31 17³/₄" x 12¹/₄"



315 316
mm. 1,2 Sottobicchiere e sottobottiglia
Glass and bottle coaster
Dessous de verre et de bouteille
Glasuntersatz - Flaschenteller
Posavaso y Posabotella
cm. 10 x 10 4" x 4"
cm. 12,5 x 12,5 5" x 5"

323

313



mm. 1,2 Sottopiatto quadrato
Square charger
Assiette de bienvenue carré
Platzteller, viereckig
Bajo plato cuadrado
cm. 32 x 32 12¹/₂" x 12¹/₂"



mm. 0,8 Sottopiatto
Charger
Assiette de bienvenue
Platzteller
Bajo plato
Ø cm. 31 Ø 12 1/4"

319

320



mm. 1,2 Vassoio quadrato
Square plate
Plateau carré
Tablett, viereckig
Bandeja cuadrada
cm. 32 x 32 12¹/₂" x 12¹/₂"



mm. 1,2 Vassoio "Tête à tête"
"Tête à tête" tray
Plateau "Tête à tête"
Tablett "Tête à tête"
Bandeja "Tête à tête"
Ø cm. 22 Ø 8 5/8"

312



mm. 1,2 Antipastiera 4 scomparti in cristallo cm. 40,5 x 27,5 15⁷/₈" x 10³/₄"
 Hors-d'oeuvre tray 4 compt.
 Plat à hors-d'oeuvre 4 comp. cristal
 Vorspeisenplatte 4 Einsatze
 Entremesera

325

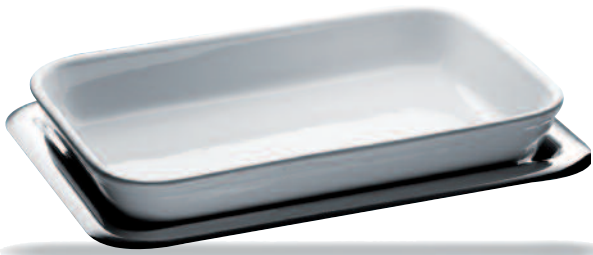

mm. 1,2 Lasagnera rettangolare cm. 40,5 x 27,5 15⁷/₈" x 10³/₄"
 Set for Lasagne lt. 3 oz. 102 ¹/₉
 Service pour Lasagne
 Set mit Porzellanschale, rech.
 Servicio para Lasagne

324



mm. 1,2 Risottiera tonda Ø cm. 31 Ø 12 ¹/₄"
 Set for risotti lt. 2 oz. 67 ³/₅
 Service pour risotto
 Set mit Porzellanschale, rund
 Servicio para arroces

309



mm. 1,2 Portatovaglioli cm. 22 x 22 8⁵/₈" x 8⁵/₈"
 Napkin holder
 Distributeur de serviettes
 Serviettenhalter
 Portaservilletas

31802



mm. 1,2 Portaspezie cm. 15 x 15 5 ⁷/₈" x 5 ⁷/₈"
 Aromatic condiments set H cm. 25,5 H 10"
 Service pour aromatiques cl. 11 (x 8) oz. 3 ³/₄ (x 8)
 condiments
 Gewürzständer
 Servicio para aromaticos y
 condimentos

308



mm. 1,2 Cestino per pane
Basket
Corbeille
Brotschale
Cuenco

cm. 22 x 22 8⁵/₈" x 8⁵/₈" mm. 1,2
cl. 80 oz. 27

Allacciatovaglioli
Napkins ring
Rond de serviette
Serviettenring
Servilletero

Ø cm. 6 Ø 2 3/8"

317

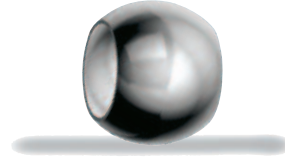

306



mm. 1,2 Completo oliera con spargisale
Cruet and salt cellar set 4 pcs.
Service huile-vinaigre 4 pcs.
Essig-/Ölgestell 4-Tlg.
Convoy vinagreras con saleros

H cm. 19 H 7³/₈"
cl. 18 (x2) oz. 6 (x2)
cl. 11 (x2) oz. 3³/₄ (x2)

mm. 1,2 Formaggera
Parmesan cheese basin
Fromagère
Kasedose
Quesera-Azucarero

cl. 20 oz. 6 3/4

307



310



mm. 1,2 Portabicchieri di carta
Paper cup holder
Porte-gobelets de papier
Papierbecherständer
Portavasos de papel

cm. 21 x 11 8³/₁₆" x 4¹/₄"
H cm. 22,8 H 8 7/8"

mm. 1,2 Portapiatti di plastica
Plastic paper plate dispenser
Porte-plateau de plastique
Stand für Plastik Platten
Portaplatos de plastica

Ø cm. 22 Ø 8 5/8"

321



164



mm. 1,2 Vassoio rettangolare
Rectangular tray
Plateau rectangulaire
Tablett, rechteckig
Bandeja rectangular

cm. 40 x 29 15³/₄" x 11³/₈"
cm. 49 x 36 19¹/₄" x 14¹/₈"

165



mm. 1,2 Vassoio rotondo
Round tray
Plateau ronde
Tablett, rund
Bandeja redonda

Ø cm. 35 Ø 13 ³/₄"

168



mm. 1,2 Completo olieria con spargisale
Cruet and salt cellar set 4 pcs
Service huile-vinaigre 4 pièces
Essig-/Ölgestell 4-Tlg.
Convoy vinagreras con saleros
4 piezas

H cm. 20 H 7⁷/₈"
cl. 18 (x 2) oz. 6 (x 2)
cl. 11 (x 2) oz. 3³/₄ (x 2)

169



mm. 1,2 Formaggera
Parmesan cheese basin
Fromagère
Kasedose
Quesera-Azucarero

cl. 20 oz. 6 ³/₄



408



mm. 1,2 TALAMO
 Vassoio rettangolare
 Rectangular tray
 Plateau rectangulaire
 Tablett, rechteckig
 Bandeja rectangular

cm. 29 x 23 11³/₈" x 9"
 cm. 47 x 37 18¹/₂" x 14¹/₂"

409



mm. 1,2 TALAMINO
 Vassoio quadrato
 Square tray
 Plateau carré
 Tablett, viereckig
 Bandeja cuadrada

cm. 37 x 37 14¹/₂" x 14¹/₂"

406

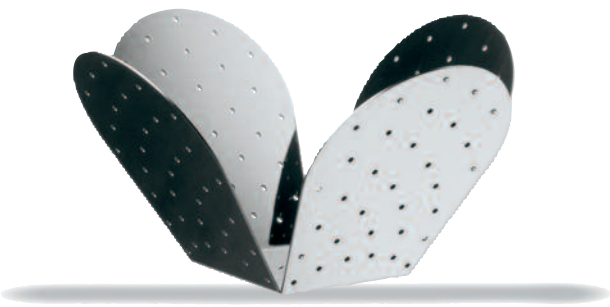

mm. 1,2 BOCCIOLO
 Cestino
 Basket
 Corbeille
 Obstschale
 Frutero

Ø cm. 24,5 Ø 9²/₃"
 H cm. 13,5 H 5¹/₃"
 lt. 4 gal. 1

407

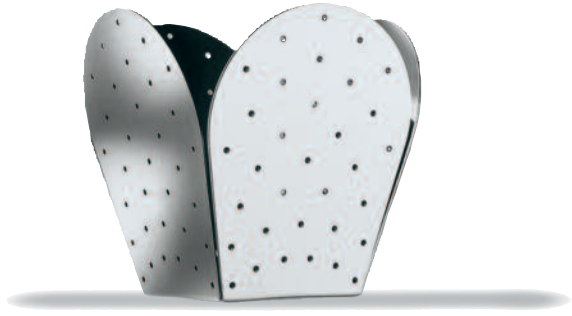

mm. 1,2 BOCCIOLINO
 Cestino
 Basket
 Corbeille
 Obstschale
 Frutero

Ø cm. 16,5 Ø 6¹/₂"
 H cm. 15,5 H 6¹/₉"
 lt. 2,64 oz. 89¹/₄

410



mm. 1,2 COROLLA
 Completo oliera con spargisale
 Cruet and salt cellar set
 Service huile-vinaigre
 Essig-/Ölgestell 4-Tlg.
 Convoy vinagreras con saleros
 H cm. 20- cl.18(x2) cl.11(x2)
 H 7⁷/₈" - oz.6(x2) oz.3³/₄ (x2)

411

PISTILLA
 Formaggera
 Parmesan cheese basin
 Fromagère
 Käsedose
 Quesera-Azucarero
 cl. 20
 oz. 6³/₄

505



mm. 1,2 COROLLA
 Cestello portacondimenti
 Basket for aromatic condiments
 Corbeille pour aromatiques condiments
 Essig-und Öl Flaschenhalter
 Cesto para aromaticos y condimentos

H cm. 20
 cl.25(x2)
 cl.11(x2)

H 7⁷/₈"
 oz.8¹/₂(x2)
 oz.3³/₄(x2)

331



mm. 1,2 Sottopiatto
Charger
Assiette de bienvenue
Platzteller
Bajo plato
Ø cm. 33 Ø 13"

333

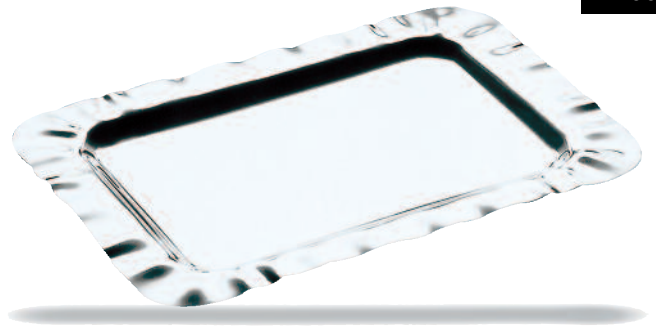

mm. 1,2 Vassoio rettangolare
Rectangular tray
Plateau rectangulaire
Tablett, rechteckig
Bandeja rectangular
cm. 50 x 34 19⁵/₈" x 13³/₈"

332



mm. 1,2 Vassoio ovale
Oval tray
Plateau oval
Tablett, oval
Bandeja oval
cm. 49 x 33 19¹/₄" x 13"

337

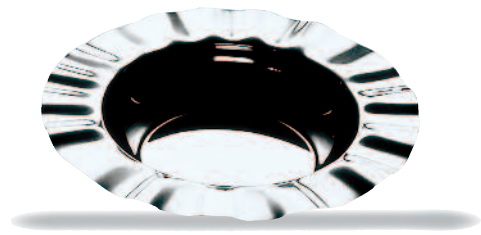

mm. 1,2 Cestino tondo
Round basket
Corbeille ronde
Obstschale, rund
Frutero redondo
Ø cm. 31 Ø 12¹/₄"
cl. 125 oz. 42 ¹/₄

335



mm. 1,2 Completo oliera con spargisale
Cruet and salt cellar set
Service huile-vinaigre
Essig-/Ölgestell 4-Tlg.
Convoy vinagreras con saleros
H cm. 21
cl.22,5(x2)
cl.7,5(x2)
H 8¹/₄"
oz.7¹/₂(x2)
oz.2¹/₂(x2)

336



mm. 1,2 Formaggera
Parmesan cheese basin
Fromagère
Käsedose
Quesera-Azucarero
cl. 20 oz. 6³/₄

201



mm. 1,2 Vassoio
Tray
Plateau
Tablett
Bandeja
cm. 30 x 24 11³/₄" x 9¹/₂"
cm. 40 x 31 15³/₄" x 12¹/₄"
cm. 50 x 39 19⁵/₈" x 15³/₈"

202



mm. 1,2 Vassoio con maniglie
Tray with handles
Plateau avec anses
Tablett mit Griffen
Bandeja con asas
cm. 40 x 31 15³/₄" x 12¹/₄"
cm. 50 x 39 19⁵/₈" x 15³/₈"

203



mm. 1,2 Vassoio
Tray
Plateau
Tablett
Bandeja
Ø cm. 25 Ø 9 ⁷/₈"
Ø cm. 31 Ø 12 ¹/₄"

199

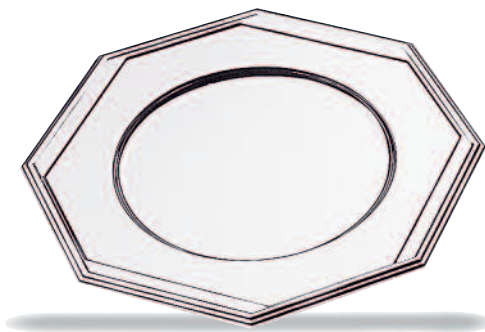

mm. 1,2 Sottopiatto
Charger
Assiette de bienvenue
Platzteller
Bajo plato
Ø cm. 31 Ø 12¹/₄"

716



mm. 0,8 Piattino per burro con coperchio e griglia
Butter dish with inserted grill and cover
Beurrer avec grill et couvercle
Butterkühler mit Einsatzsieb und Deckel
Plato para mantequilla con rejilla y tapa
Ø cm. 9 cl. 25 Ø 3¹/₂"
oz 8 ¹/₂

210

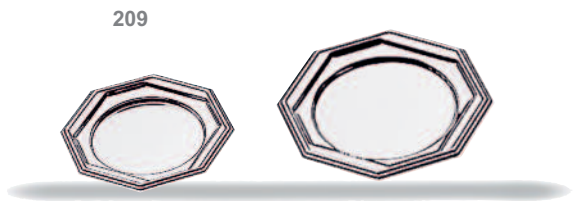

mm. 0,8 Sottobicchiere e sottobottiglia
Glass and bottle coaster
Dessous de verre et de bouteille
Glasuntersatz - Flaschenteller
Posavaso y Posabotella
209
Ø cm. 10,5 Ø 4¹/₈"
Ø cm. 12,5 Ø 4⁷/₈"

502



mm. 0,8 Completo olieria con spargisale
Cruet and salt cellar set
Service huile-vinaigre 4 pièces
Essig-/Ölgestell 4-Tlg.
Convoy vinagreras con saleros 4 pzs

H cm. 21 H 8 1/4"
cl. 22,5 (x 2) oz. 7 1/2 (x 2)
cl. 7,5 (x 2) oz. 2 1/2 (x 2)

522



mm. 0,8 Formaggera
Parmesan cheese basin
Fromagère
Käsedose
Quesera-Azucarero

cl. 20 oz. 6 3/4

844



mm. 1,2 Cestino rettangolare
Rectangular basket
Corbeille rectangulaire
Obstschale rechteckig
Panera rectangular

cm. 30 x 24 11 3/4" x 9 1/2"
cl. 200 oz. 67 5/8

843



mm. 1,2 Cestino
Round Basket
Corbeille
Obstschale
Frutero

Ø cm. 25 Ø 9 7/8"
cl. 150 oz. 50 3/4

103



mm. 1,2 Sottopiatto Ø cm. 33 Ø 13"
 Charger Ø cm. 35 Ø 13 3/4"
 Assiette de bienvenue
 Platzteller
 Bajo plato

131



mm. 0,8 Sottopiatto RAFFAELLO Ø cm. 32,5 Ø 12 3/4"
 Charger »
 Assiette de bienvenue »
 Platzteller »
 Bajo plato »

294



mm. 1,2 Porta pasticcini con piedistallo Ø cm. 19 Ø 7 1/2"
 Petit-fours stand with base H cm. 14,5 H 5 3/4"
 Porte-petits-fours avec socle
 Petit Fours-Ständer Ø cm. 24 Ø 9 1/2"
 Porta dulces con pedestal H cm. 14,5 H 5 3/4"

7003A



mm. 1,2 Alzata portafrutta 2 piani Ø cm. 24 Ø 9 1/2"
 Fruit holder 2 layers Ø cm. 31 Ø 12 1/4"
 Serviteur 2 etages H cm. 24,5 H 9 5/8"
 Etager 2 stufig
 Frutero 2 pisos

293



mm. 1,2 Porta pasticcini con piedistallo 2 Piani Ø cm. 12 Ø 4 3/4"
 Petit-fours stand with base 2 Layers Ø cm. 19 Ø 7 1/2"
 Porte-petits-fours avec socle 2 Etages H cm. 27 H 10 5/8"
 Mokkaetager 2 Ebenen
 Porta dulces con pedestal 2 Pisos

7003B



mm. 1,2 Alzata portafrutta 3 piani Ø cm. 19 Ø 7 1/2"
 Fruit holder 3 layers Ø cm. 24 Ø 9 1/2"
 Serviteur 3 etages Ø cm. 31 Ø 12 1/4"
 Etager 3 stufig H cm. 35,5 H 14"
 Frutero 3 pisos

204



mm. 1,2 Porta macaron
Macarons server
Porte macarons
Macaronsträger
Porta macaron

Ø cm. 15 Ø 5 7/8"
H cm. 11,5 H 4 1/2"
cl. 20 oz. 6 3/4

715



mm.0,8 Piattino per burro con coperchio e griglia
Butter dish with inserted grill and cover
Beurrer avec grille et couvercle
Butterdose mit Einsatzsieb und Deckel
Plato para mantequilla con rejilla y tapa

Ø cm. 9 Ø 3 1/2"
cl. 20 oz. 6 3/4

105



mm. 1,2 Sottobicchiere
Glass coaster
Dessous de verre
Glasuntersatz
Posavasos

Ø cm. 10 Ø 4"

106



mm.1,2 Sottobottiglia
Bottle coaster
Dessous de bouteille
Flaschenteller
Posabotella

Ø cm. 12 Ø 4 3/4"

208



mm. 1,2 Piattino per pane
Bread tray
Plat pour pan
Brot Platte
Plato para pan

Ø cm. 14 Ø 5 1/2"

292



mm. 1,2 Servizio per zucchero con cristallo
Sugar set with crystal
Service à sucre avec cristal
Zuckerständer mit Kristalleinsätzen
Servicio para azúcar con cristales

Ø cm. 33 Ø 13"
cl. 15(x3) oz. 5(x3)

497



mm. 1,2 Completo oliera con spargisale 5 pz. H.cm.21 H. 8 1/4"
 Cruet and salt cellar set 5 pcs cl. 30 (x2) oz. 10 1/8 (x2)
 Service huile-vinaigre 5 pièces cl. 8 (x3) oz. 2 3/4 (x3)
 Essig-Ölgestell 5-Tlg.
 Vinagreras 5 pza

509



mm. 1,2 Completo oliera con spargisale 4 pz. H.cm.21 H. 8 1/4"
 Cruet and salt cellar set 4 pcs cl. 30 (x2) oz. 10 1/8 (x2)
 Service huile-vinaigre 4 pièces cl. 8 (x2) oz. 2 3/4 (x2)
 Essig-Ölgestell 4-Tlg.
 Vinagreras 4 pza

508



mm. 1,2 Oliera H.cm.21 H. 8 1/4"
 Cruet cl. 30 (x2) oz. 10 1/8 (x2)
 2 pièces huile-vinaigre
 Essig-Ölgestell 2 Tlg.
 Vinagreras 2 pza

510



mm. 1,2 Spargisale portastecchi con base H. cm.14 H. 5 1/2"
 Salt cellar w/toothpick container w/base cl. 8 (x3) oz. 2 3/4 (x3)
 Sel, poivre, porte cure-dents a/socle
 Salz-Pfeffer-Zahnstocherbehälter 3-tlg.
 Sal & Pimenta & palillero 3 pza

350



Cristallo per spargisale art. 510
 Salt and pepper container for art. 510
 Cristal pour art. 510
 Ersatzglass für Art. 510
 Cristal por saleros art. 510
 cl. 8
 oz. 2 3/4

Ampolla
 Cruet
 Huilliere
 Öl-/Essigflasche
 Vinagrera
 H cm. 18 - cl. 30
 H 7 1/8" - oz. 10 1/8

510ST



Portastecchi senza base cl. 8 oz. 2 3/4
 Toothpick container w/out base
 Porte cure-dents sans/socle
 Zahnstocherbehälter ohne Fuß
 Palillero sin pedestal

611



mm. 1,2 Formaggera
Parmesan cheese basin
Fromagère
Käsedose
Quesera - Azucarero
cl. 20 oz. 6 3/4

512

430491SS



Cristallo per spargisale art. 512-602
Crystal glass container for art. 512-602
Cristal avec capsule pour art. 512-602
Erzatzglass mit Kapsel für art. 512-602
Cristal por saleros art. 512-602
cl. 11 - oz. 3 3/4

mm. 1,2 Spargisale-portastecchi
Salt cellar with toothpick container
Sel + poivre + cure dents
Salz-Pfeffer-Zahnstocherbehälter
Saleros y pimenteros y palillero
H. cm.14 - cl. 11(x2)
H. 5 1/2" - oz. 3 3/4 (x2)

602

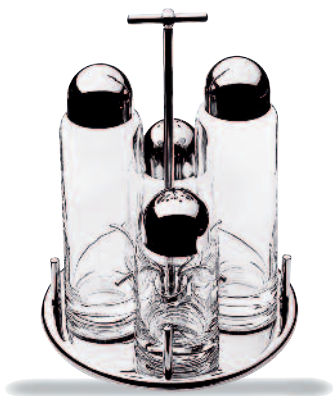

mm. 1,2 Completo oliera con spargisale
Cruet and salt cellar set
Service huile-vinaigre 4 pièces
Essig-Ölgestell 4-tlg.
Convoy vinagreras con saleros
H. cm 19 H. 7 1/2"
cl. 18(x2) oz. 6(x2)
cl. 11(x2) oz. 3 3/4(x2)

601

430602



mm. 1,2 Oliera
Cruet
2 pièces huile-vinaigre
Essig-Ölgestell
Vinagreras
H. cm 19 H. 7 1/2"
cl. 18(x2) oz. 6(x2)

603



mm. 1,2 Oliera portacondimenti
Cruet for aromatic condiments
Huilière pour aromatiques condiments
Gewürzmenage
Vinagreras para aromaticos
y condimentos
H. cm 14,5 H. 5 3/4"
cl. 11(x2) oz. 3 3/4(x2)

430491

304



304
mm 1,2 Portamarmellata a 3 scomparti
Jam pack holder 3 compt.
Porte-confiture 3 comp.
Marmeladegestell 3 Einsätze
Marmeladero 3 comp.
H. cm. 19 - H. 7 1/2"

604

mm. 1,2 Oliera a 3 pezzi
Cruet 3 pcs
Huilière 3 pcs
Menage 3-Tlg.
Vinagreras 3 pzas
H. cm. 19 -cl.18(x2)-cl. 11
H. 7 1/2" - oz.6(x2) oz.3 3/4

231



| | | | |
|---------|--|-------------|-------------------|
| mm. 0,8 | Piatto ovale da portata bordo rinforzato | cm. 25 x 17 | 9 7/8" x 6 3/4" |
| | Oval serving plate with reinforced edges | cm. 30 x 21 | 11 3/4" x 8 1/4" |
| | Plat oval de service bord renforcé | cm. 35 x 24 | 13 3/4" x 9 1/2" |
| | Bratenplatte oval | cm. 40 x 27 | 15 3/4" x 10 5/8" |
| | Fuente ovalada borde reforzado | cm. 45 x 32 | 17 3/4" x 12 5/8" |
| | | cm. 50 x 35 | 19 5/8" x 13 3/4" |
| | | cm. 60 x 41 | 23 5/8" x 16 1/8" |

241



| | | |
|---------|--|-------------------|
| mm. 0,8 | Piatto ovale da portata pesce bordo rinforzato | cm. 55 x 24 |
| | Oval serving fish plate with reinforced edges | cm. 70 x 29 |
| | Plat à poisson oval bord renforcé | |
| | Fischplatte, oval | 21 5/8" x 9 1/2" |
| | Fuente pescado borde reforzado | 27 1/2" x 11 3/8" |

233



| | | | |
|---------|---|-------------|-------------------|
| mm. 1,2 | Piatto ovale da portata mod. pesante | cm. 30 x 22 | 11 3/4" x 8 5/8" |
| | Oval serving plate with reinforced edges heavy mod. | cm. 35 x 26 | 13 3/4" x 10 1/2" |
| | Plat oval de service bord renforcé Mod. pesant | cm. 40 x 28 | 15 3/4" x 11" |
| | Bratenplatte, oval, schweres Mod. | cm. 45 x 31 | 17 3/4" x 12 1/4" |
| | Fuente ovalada nuevo modelo | cm. 50 x 34 | 19 5/8" x 13 3/8" |

243



| | | |
|---------|--|-------------------|
| mm. 1,2 | Piatto ovale da portata pesce mod. pesante | cm. 55 x 25 |
| | Oval serving fish plate heavy weight | cm. 70 x 27 |
| | Plat à poisson modèle Pesant | |
| | Fischplatte, oval, schweres Mod. | 21 5/8" x 9 7/8" |
| | Fuente ovalada pescado nuevo modelo | 27 1/2" x 10 5/8" |

251



| | | | |
|---------|--|----------|-----------|
| mm. 0,8 | Piatto rotondo da portata bordo rinforzato | Ø cm. 27 | Ø 10 5/8" |
| | Round serving plate with reinforced edges | Ø cm. 30 | Ø 11 3/4" |
| | Plat rond de service bord renforcé | Ø cm. 35 | Ø 13 3/4" |
| | Bratenplatte, rund | Ø cm. 40 | Ø 15 3/4" |
| | Bandeja redonda borde reforzado | | |

269



| | | | | |
|---------|---------------------------------|------|---------|-------|
| mm. 0,8 | Copripiatto sovrapponibile | GALA | Ø cm.28 | Ø 11" |
| | Stackable cover for round plate | » | | |
| | Couvre-plat | » | | |
| | Stapelbarer Teller cloche | » | | |
| | Cubre platos | » | | |



263



mm. 0,8 Piatto tondo per legumi a 3 sc. Ø cm. 27 Ø 10 5/8"
 3 sections vegetable dish
 Plat à légumes rond - 3 compt.
 Teller rund 3 Abteilungen
 Bandeja para legumbres 3 comp.

264



mm. 0,8 Coperchio per piatto tondo art. 263 Ø cm. 25 Ø 9 7/8"
 Lid for art. 263
 Couvercle pour plat rond art. 263
 Deckel für Teller 3 Abtlg.
 Tapa para bandeja redonda art. 263

266



mm. 0,8 Piatto ovale per legumi a 2 sc. cm. 30 x 21 11 3/4" x 8 1/4"
 2 section vegetable dish
 Plat à légumes oval - 2 comp.
 Teller oval, 2 Abteilungen
 Bandeja para legumbres 2 comp.

267



mm. 0,8 Coperchio per piatto ovale art. 266 cm. 27 x 18 10 5/8" x 7 1/8"
 Lid for art. 266
 Couvercle pour plat oval art. 266
 Deckel für Teller, 2 Abtlg.
 Tapa para bandeja ovalada art. 266

235



mm. 1,2 Vassoio per gratin cm. 35 x 20 13 3/4" x 7 1/8"
 Tray for "gratin" cm. 40 x 24 15 3/4" x 9 1/2"
 Plat à "gratin"
 Gratinplatte
 Bandeja gratinar
 15 3/4" x 9 1/2"

236



mm. 0,8 Coperchio per Art. 235 cm. 35 x 20 13 3/4" x 7 1/8"
 Lid for Art. 235 cm. 40 x 24 15 3/4" x 9 1/2"
 Couvercle pour Art. 235
 Deckel für Art. 235
 Tapa para Art. 235

253



mm. 0,8 Cloche per piatto rotondo
Cloche for round plate
Cloche pour plat rond
Tellercloche für Bratenplatte rund
Tapa para fuente redonda

| | |
|----------|-----------|
| Ø cm. 27 | Ø 10 5/8" |
| Ø cm. 35 | Ø 13 3/4" |
| Ø cm. 40 | Ø 15 3/4" |

245



mm. 0,8 Cloche per piatto ovale
Cloche for oval plate
Cloche pour plat oval de service
Tellercloche für Bratenplatte oval
Tapa para fuente ovalada

| | |
|--------|---------|
| cm. 30 | 11 3/4" |
| cm. 35 | 13 3/4" |
| cm. 40 | 15 3/4" |
| cm. 45 | 17 3/4" |
| cm. 50 | 19 5/8" |

211



mm. 0,6 Vassoio rettangolare per pasticceria
Rectangular tray for cakes
Plat à tarte rectangulaire
Gebäckplatte, rechteckig
Bandeja

| | |
|-------------|------------------|
| cm. 26 x 19 | 10 1/4" x 7 1/2" |
| cm. 31 x 21 | 12 1/4" x 8 1/4" |

238



mm. 1,2 Vassoio per gratin e gastronomia
Tray for "Gratin-gastronomy"
Plat à "Gratin et gastronomie"
Gratinplatte für Gastronomie
Bandeja para gratinar y gastronomia

| | |
|-------------|-------------------|
| cm. 25 x 18 | 9 7/8" x 7 1/8" |
| cm. 30 x 22 | 11 3/4" x 8 5/8" |
| cm. 35 x 25 | 13 3/4" x 9 7/8" |
| cm. 40 x 29 | 15 3/4" x 11 3/8" |
| cm. 45 x 31 | 17 3/4" x 12 1/4" |

247



mm. 0,8 Cloche con pomolo per sottopiatto
Cloche with knob for under plate
Cloche pour sous-assiette
Tellercloche
Tapa para fuente redonda

| | |
|------------|-----------|
| Ø cm. 7,5 | Ø 3" |
| Ø cm. 10 | Ø 4" |
| Ø cm. 10,5 | Ø 4 1/16" |
| Ø cm. 13 | Ø 5 1/16" |
| Ø cm. 13,2 | Ø 5 1/5" |
| Ø cm. 14 | Ø 5 1/2" |
| Ø cm. 14,5 | Ø 5 5/7" |
| Ø cm. 20 | Ø 7 7/8" |
| Ø cm. 22 | Ø 8 5/8" |
| Ø cm. 24 | Ø 9 1/2" |
| Ø cm. 26 | Ø 10 1/4" |
| Ø cm. 28 | Ø 11" |
| Ø cm. 30 | Ø 12 1/8" |
| Ø cm. 31 | Ø 12 1/8" |
| Ø cm. 32 | Ø 12 5/8" |
| Ø cm. 33 | Ø 13" |

268



mm. 0,8 Copripiatto sovrapponibile
Stackable cover for round plate
Couvre-plat
Stapelbarer Tellercloche
Cubre platos

| | |
|----------|-----------|
| Ø cm. 20 | Ø 7 7/8" |
| Ø cm. 24 | Ø 9 1/2" |
| Ø cm. 26 | Ø 10 1/4" |
| Ø cm. 27 | Ø 10 5/8" |
| Ø cm. 28 | Ø 11" |
| Ø cm. 30 | Ø 11 3/4" |
| Ø cm. 31 | Ø 12 3/8" |
| Ø cm. 33 | Ø 13" |

732



mm. 1,2 Zuppiera nuovo modello Ø cm. 14 - lt. 0,6 Ø 5 1/2" - oz. 20 1/4
 Soup tureen new mod. Ø cm. 18 - lt. 1,2 Ø 7" - oz. 40 5/8
 Soupière nouveau modele Ø cm. 20 - lt. 1,8 Ø 7 7/8" - oz. 60 7/8
 Suppenterrine neues Mod. Ø cm. 22 - lt. 2,5 Ø 8 5/8" - oz. 84 1/2
 Sopera nuevo Modelo Ø cm. 24 - lt. 3,1 Ø 9 1/2" - oz. 104 7/8
 Ø cm. 26 - lt. 3,9 Ø 10 1/4" - oz. 131 7/8
 Ø cm. 28 - lt. 5,1 Ø 11" - gal. 1 1/4

782



mm. 1,2 Legumiera nuovo modello Ø cm. 14 - lt. 0,6 Ø 5 1/2" - oz. 20 1/4
 Vegetable dish new model Ø cm. 18 - lt. 1,2 Ø 7" - oz. 40 5/8
 Légumiere nouveau modele Ø cm. 20 - lt. 1,8 Ø 7 7/8" - oz. 60 7/8
 Lègumier neues Modell Ø cm. 22 - lt. 2,5 Ø 8 5/8" - oz. 84 1/2
 Legumbrera nuevo Modelo Ø cm. 24 - lt. 3,1 Ø 9 1/2" - oz. 104 7/8
 Ø cm. 26 - lt. 3,9 Ø 10 1/4" - oz. 131 7/8
 Ø cm. 28 - lt. 5,1 Ø 11" - gal. 1 1/4

736



mm. 1,2 Coperchio per art. 732 - 782 Ø cm. 14 Ø 5 1/2"
 Lid for art. 732 - 782 Ø cm. 18 Ø 7"
 Couvercle pour art. 732 - 782 Ø cm. 20 Ø 7 7/8"
 Deckel für art. 732 - 782 Ø cm. 22 Ø 8 5/8"
 Tapa para art. 732 - 782 Ø cm. 24 Ø 9 1/2"
 Ø cm. 26 Ø 10 1/4"
 Ø cm. 28 Ø 11"

701



10131140

mm. 1,2 Salsiera mod. "Aladino" cl. 10 oz. 3 3/8
 Gravy boat mod. "Aladino" cl. 15 oz. 5 1/8
 Saucière mod. "Aladino" cl. 30 oz. 10 1/8
 Sauciere mod. "Aladino"
 Salsera mod. "Aladino"
 Mestolino per salsa Lungn. cm. 18,7 Long. 7 3/8"
 Ladle for gravy boat
 Cuillère à sauce
 Saucenlöffel
 Cacillo para salsera

511



430511SS

mm. 0,8 Completo spargisale-portastecchi H cm. 14 H 5 1/2"
 Salt-cellar with toothpick container cl. 8 oz. 2 3/4
 Sel+poivre+porte cure-dents
 Salz+Pfeffer+Zahnstocherbehälter
 Saleros y pimentero y palillero

731



mm. 1,2 Zuppiera monoporzione demitasse Ø cm 12 Ø 4 3/4"
 Soup cup with base cl. 35 oz. 11 7/8
 Soupiere sur socle avec anses
 Suppentasse auf Fuss
 Taza para sopa con pedestal

772



mm. 0,8 Molla per ghiaccio
Ice tongs
Pince à glaçon
Eiszange
Pinzas hielo
Lungh. cm. 15,5
Length 6 1/8"

778



mm. 2,0 Molla per ghiaccio
Ice tongs
Pince à glaçon
Eiszange
Pinzas hielo
Lungh. cm. 18
Length 7 1/8"

382

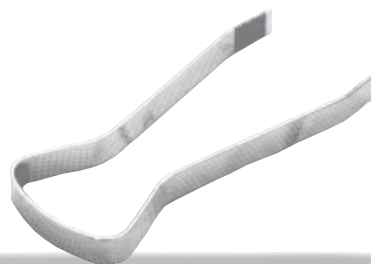

mm. 2,0 ERGONOMICA
Molla per ghiaccio
Ice tongs
Pince à glaçon
Eiszange
Pinzas hielo
Lungh. cm. 17
Length 6 5/8"

774



mm. 0,8 Molla per dolci
Pastry tongs
Pince à gateaux
Gebäckzange
Pinzas dulces
Lungh. cm. 19
Length 7 1/2"

777



mm. 0,8 Molla per spaghetti
Spaghetti/Pasta
tongs
Pince à spaghetti
Spaghettizange
Pinzas spaghetti
Lungh. cm. 21
Length 8 1/4"

775

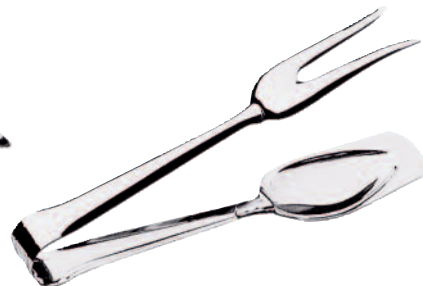

mm. 0,8 Molla per arrosto e verdure
Roasts and vegetables tongs
Pince à salade et à rôti
Servierzange
Pinzas asado y verduras
Lungh. cm. 21
Length 8 1/4"

779



mm. 0,8 Molla per lumache
Escargot tongs
Pince à escargots
Schneckenzange
Pinzas para caracoles
Lungh. cm. 16
Length 6 1/4"

771



mm. 0,8 Molla per zucchero
Sugar tongs
Pince à sucre
Zuckerzange
Pinzas azúcar
Lungh. cm. 14
Length 5 1/2"

752

741



mm. 0,8 Piattino per lumache Ø cm. 13,5-6pz. Ø 5 3/8" - 6pcs.
 Escargot dish Ø cm. 18 - 12pz. Ø 7 1/8" - 12pcs.
 Plat à escargots
 Schneckenplatte
 Plato caracoles

Molla per lumache Lungh. cm. 16 Length 6 1/4"
 Tongs for snails
 Pince à escargots
 Schneckenzange
 Pinzas para caracoles



mm. 0,8 Tegamino friggiuova Ø cm. 16 Ø 6 1/4"
 Frying pan for eggs
 Plat à oeuf
 Eierpfanne
 Plato huevos

904

911



mm. 1,2 Posacenere cm. 14 x 12 5 1/2" x 4 3/4"
 Ash-tray
 Cendrier
 Ascher
 Cenicero



mm. 0,6 Scodella lavadita Ø cm. 12 Ø 4 3/4"
 Finger bowl cl. 30 oz. 10 1/8
 Ecuelle
 Fingerbowl
 Lavadedos

956

528



mm. 1,2 Cloche copriburro o per antipasti Ø cm. 10,5 Ø 4 1/16"
 Cloche for hors d'oeuvre or butter plate Ø cm. 13 Ø 5 1/16"
 Cloche dome pour assiette
 Cloche für Vorspeisen- oder Butterteller
 Tapa para mantequera o para platos
 por entremes



mm. 1,2 Formaggera ODEON cl. 20 oz. 6 3/4
 Parmesan cheese basin »
 Fromagère »
 Käsedose »
 Quesera-Azucarero »

998



Ø mm 8,0 Portabottiglia
Bottle stand
Porte-bouteille
Rotweinwiege
Portabotella

H cm. 23 H 9"
cm. 21 x 5,5 8 1/4" x 2 1/6"

711



mm. 0,6 Portauovo
Egg-cup
Coquetier
Eierbecher
Huevera

cm 15 x 9 5 7/8" x 3 1/2"

707



mm. 1,2 Portaburro
Butter dish
Beurrer
Butterdose mit Deckel
Mantequera
cm. 11 x 20
4 3/8" x 7 7/8"

799P



799W



799N



Ciotola quadra
Square bowl
Bol, carré
Universalschale auf Holz, quadr.
Cuenco cuadrado
cm. 6 x 6
2 3/8" x 2 3/8"

TRE
"
"
"
"



mm. 1,2 Ciotola per antipasto UNO
Snack bowl »
Bol à snacks »
Snackschale »
Cuenco por entremes »
Ø cm 9
Ø 3 1/2"

544

504



Ø cm. 19
H cm. 27
Ø 7 1/2"
H 10 5/8"

504



cm. 17,5 x 16,5
H cm. 29,5
6 7/8" x 6 1/2"
H 11 3/5"

503



cm. 26 x 12
H cm. 28,5
10 1/4" x 4 3/4"
H 11 1/5"

356



355

cm. 12 x 6
H cm. 28,5

355

Ø mm. 6,0 Cestelli portacondimenti da tavola
Basket for aromatic condiments
Corbeilles pour condiments aromatiques
Tisch-Essig/Öl Flaschenhalter
Cestos para aromaticos y condimentos

mm. 1,2 Cestelli portacondimenti da buffet
Basket for aromatic condiments
Corbeilles pour condiments aromatiques
Buffet-Essig/Öl Flaschenhalter
Cestos para aromaticos y condimentos

4 3/4" x 2 1/3"
H 11 1/5"

446



mm. 1,2 8 1/2
Portatoast
Toast rack
Porte-toast
Toastständer
Portatostadas

cm. 21 x 7,5
8 1/4" x 3"

451



mm. 1,2 Portatoast
Toast rack
Porte-toast
Toastständer
Portatostadas

cm. 21 x 7,5
8 1/4" x 3"

NEW



mm. 1,2 Portatoast
Toast rack
Porte-toast
Toastständer
Portatostadas

cm. 21 x 7,5
8 1/4" x 3"

903



Segnaposto
Table number stand
Numéro de table
Tischnummern-Aufsteller
Numero de mesa
mm. 0,6

cm 11 x 9

4 3/8" x 3 1/2"

85303



Segnaposto
Table number stand
Numéro de table
Tischnummern-Aufsteller
Numero de mesa
mm. 3,0

H cm. 8
cm 8 x 8

H 3 1/8"
3 1/8" x 3 1/8"

996

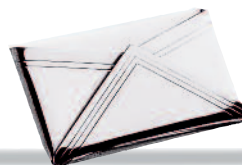

Portanumero
Table number stand
Numéro de table
Tischnummern-Ständer
Numero de mesa
mm. 0,6

cm. 9,5 x 5 Ø cm.10
H cm 10

3 3/4" x 2"
Ø 4"
H 4"

901



289



mm.1,2
Porta cono patatine GALA
Chips cone holder "
Porte pommes frites "
Eis-Kartoffenbehälter "
Porta cono patatas fritas "
Ø cm.6 - H cm. 10
Ø 2" - H 3 3/8"



726

mm.1,2
Coppa Martini
Martini Glass
Verre à Martini
Martini glas
Vaso para Martini
cl. 11 oz. 3 3/4
cl. 20 oz. 6 3/4

727



727

mm.1,2
Coppa per intermezzo
Intermezzo cup
Coupe à intermezzo
Sorbeteschale
Copa para intermezzo
cl. 4
oz. 1 3/8

152

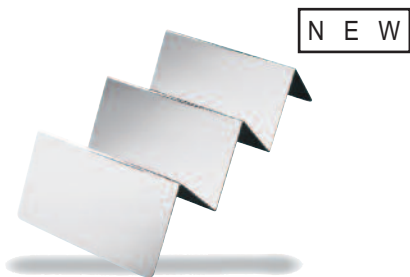

mm. 1,2 Porta tacos
Tacos Holder
Support pour tacos
Tacoshalter
Porta Tacos

cm 20 x 10 7 3/4" x 3 7/8"
H cm 5 H 2"

314



mm. 1,2 Vassoio concavo ERGONOMICA
Crescent tray »
Plateau concave »
Konkave Tablett »
Bandeja concavo »

cm 40 x 19 15 3/4" x 7 1/2"
cm 55 x 28 21 5/8" x 11"

232



mm. 1,2 Vassoio per self service
Cafeteria tray
Plateau pour self service
Tablett für self service
Bandeja para self service

cm. 40 x 30 15 3/4" x 11 7/8"

905



mm. 0,8 Portagrissini
Bread sticks holder
Porte gressin
Grissini-Halter
Porta bastoncillos de pan

Ø cm 10 Ø 3 7/8"
H cm. 17 H 6 5/8"

675



mm. 0,8 Portabottiglia antirollio per yacht
Yachting non-slip bottle holder
Cache eau minerale avec anneau antiderapant
Antiroll-Spezialflaschenhalter für Yachten
Portabotella antibalaceo para yacht

Ø cm. 10
H cm. 17
Ø 3 7/8"
H 6 5/8"

496AC

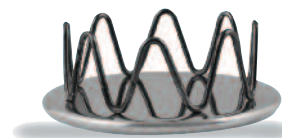

mm. 1,2 Salvagoccia bottiglia vino rosso
Anti-drop wine bottle coaster
Dessous de bouteille de vin
anti-goutte
Tropfen einflaschenuntersetzer
Posabotella antigoteo por vino

Ø cm. 11,5 Ø 4 1/2"

229

230



mm. 1,2 Portasalse per fiorentina o tartara
Sauce set for Florentine or Tartar steak
Service à sauce pour Florentin ou Tartare
Sauce Set für Florentine oder Tartar Steak
Servicio para salsa por bistek Tartara y Florentina

cl. 35 (x4) oz. 117/8 (x4)



mm. 1,2 Completo portasalse per fiorentina o tartara
Complete sauce set for Florentine or Tartar steak
Service à sauce complet pour Florentin ou Tartare
Sauce Set für Florentine oder Tartar Steak
Servicio para salsa por bistek Tartara y Florentina

cm. 40 x 27 15 3/4" x 10 5/8"
cl. 35 (x4) oz. 117/8 (x4)

094

098



mm. 1,2 Cestino rotondo CAMELLA
Round basket
Corbeille ronde
Obstschale, rund
Frutero redondo

Ø cm. 27 Ø 10 5/8"



mm. 1,2 Vassoio CAMELLA
Tray
Plateau
Tablett
Bandeja

cm. 35 x 23 13 3/4" x 9 1/4"
cm. 40 x 27 15 3/4" x 10 5/8"

721

356



mm. 1,2 Coppa termica con cloche
Insulated cup with cloche
Coupe thermique avec cloche
Isolier-Eisfruchtbecher mit Deckel
Copa térmica con tapa

Ø cm. 8,5 Ø 3 1/3"
cl. 15 oz. 6



mm. 1,2 Cestello portacondimenti da buffet
Basket for aromatic condiments
Corbeille pour condiments aromatiques
Buffet-Essig/Öl Flaschenhalter
Cesto para aromáticos y condimentos"

cm. 26 x 12
H cm. 28,5
10 1/4" x 4 3/4"
H 11 1/5"

280



mm. 1,2 Set per ceviche in acciaio inossidabile 18/10
18/10 Stainless Steel ceviche set
Set pour ceviche en acier inoxydable 18/10
Cevicheset in Rostfreie Stahl 18/10
Cevichera en acero inoxidable 18/10

607 Ø cm. 27 H cm. 13,5 lt. 5
58922 Ø cm. 22 H cm. 14 cl. 220

607 Ø 10 1/2" H 5 1/4" gal. 1 1/3
58922 Ø 8 1/2" H 5 1/2" oz. 74 3/8

281



mm. 1,2 Set per ceviche in policarbonato
Polycarbonate ceviche set
Set pour ceviche en polycarbonate
Cevicheset in Polikarbonat
Cevichera en policarbonado

58928 Ø cm. 28 H cm. 17,3 lt. 6,03
58922 Ø cm. 22 H cm. 14 cl. 220

58928 Ø 11" H 6 5/8" oz. 202 1/2
58922 Ø 8 1/2" H 5 1/2" oz. 74 3/8

994C



mm. 1,2 Portanumero piccolo
Mini table number stand
Numbers etched to order
Mini marquer de table
Mini Tischnummernständer
Porta numero de mesa pequeño

H cm. 7 H 2 3/4"

913



mm. 1,0 Porta badge in acciaio magnetico
Badge holder in magnetic steel
Porte-badge en acier magnétique
Badge-Halter in magnetischem Stahl
Porta tarjeta de acero magnético

cm. 8 x 4,5 3 1/7" x 1 3/4"

225



Cloche trasparente
Transparent cloche
Cloche transparente
Transparent Tellercloche
Tapa transparente

Ø cm. 12 Ø 4 3/4"
Ø cm. 22 Ø 8 1/2"
Ø cm. 28 Ø 11"

mm. 1,2 Portastuzzicadenti con base
Toothpick container with base
Porte-cure-dents avec socle
Zahnstocherbehälter auf Fuss
Porta-palillos con base

Ø cm. 4 Ø 1 1/2"
H cm. 5,8 H 2 1/4"
cl. 5 oz. 1 3/4

709



047



Colino da cocktail
Cocktail strainer
Passoire à cocktail
Cocktailsieb
Colador para coctelera

cm. 22 8 2/3"

049



Cavatappi
Cork screw / Bottle opener
Ouvre boîte - Ouvre-bouteilles
Korkenzieher
Abrebotellas

H cm. 19 H 7 1/2"

025



Grattugia
Grater
Râpe
Reibe
Rallador

cm. 23 9"

048



Schiaccianoci
Nutcracker
Casse noix
Nussknacker
Rompenueces

cm. 20 7 7/8"

473



ATTILA
Cavatappi
Cork screw / Bottle opener
Décapsuleur
Korkenheber
Abrebotellas

cm. 10 3 7/8"

mm. 1,2

10001108



Cucchiaino per caviale
Caviar spoon
Cuillère à caviar
Kaviarlöffel
Cucharita caviar

cm. 11,8 4 2/3"

447



JOKER
Macinapepe
Pepper mill
Moulin à poivre
Pfeffermühle
Molinillo de pimienta

Ø cm. 4 Ø 1 1/2"
H cm. 15 H 5 7/8"

464



ETNA
Macinasale
Salt mill
Moulin à sel
Salzmühle
Molinillo de sal

Ø cm. 4 Ø 1 1/2"
H cm. 15 H 5 7/8"

466



MANOLO
Macinapeperoncino
Chilli mill
Moulin à piment
Chilimühle
Molinillo de chile

Ø cm. 4 Ø 1 1/2"
H cm. 15 H 5 7/8"

462



PARDON
Tagliatartufi
Truffles slicer
Coupe truffes
Trüffel Hobel
Cortador de trufas

cm. 20 x 8 7 7/8" x 3 1/7"

104



mm. 1,2 EPOQUE
Sottopiatto e Sottobottiglia
Charger and Bottle coaster
Assiette de bienvenue et
Dessous de bouteille
Platz- und Flaschenteller
Bajo plato y Posabotella

Ø cm. 34 Ø 13 3/8"
Ø cm. 14,5 Ø 5 3/4"

133

671



mm. 1,0 Vasetto portafiori H. cm. 14 H. 5 1/2"
Flower vase
Vase à fleur
Blumenvase
Florero

757



mm. 1,2 ORCHIDEA
 Appoggia borse
 Bags support
 Soutier de sacs
 Beutelstand
 Apoya bolsas

cm. 30 x 40 11 7/8" x 15
 H cm. 30 3/4"

758



mm. 1,2 PEONIA
 Appoggia borse
 Bags support
 Soutier de sacs
 Beutelstand
 Apoya bolsas

cm. 37 x 31 14 5/8" x 12
 H cm. 33 1/4"

755



mm. 1,2 IRIS
 Appoggia borse
 Bags support
 Soutier de sacs
 Beutelstand
 Apoya bolsas

Ø cm. 35 13 3/4"
 H cm. 38 H 15"

756



mm. 1,2 BIANCOSPINO
 Appoggia borse
 Bags support
 Soutier de sacs
 Beutelstand
 Apoya bolsas

Ø cm. 37 14 5/8"
 H cm. 37 H 14 5/8"





Tea Time

94003

976S



mm. 1,2 Servizio per zucchero
Sugar set
Service pour sucre
Zucker Menage
Juego azucar

cl. 15 (x3) oz. 5/8 (x3)
cl. 15 (x4) oz. 5/8 (x4)

976C



mm. 1,2 Portasalatini impilabile
Stackable snack server
Support à snack empilable
Stapelbare Relish-Pickles-Gestell
Servicio por entremes impilable

Ø cm. 20 Ø 7 7/8"
cl. 15 (x3) oz. 5/8 (x3)

976C Ø cm. 20 Ø 7 7/8"
H cm 15 H 5 7/8"
cl. 15 (x3) oz. 5/8 (x3)

984

974



Alzata portapiatti
Afternoon tea stand
Présentoir à gateau
Dessert-Serviergestell
Soporte platos

984 Ø cm 22 Ø 8 3/16"
H.cm.45 H 17 1/4"
985 Ø cm 18 Ø 7 1/8"
H.cm.33 H 13"
989 Ø cm 30 Ø 11 3/4"
H.cm.52 H 20 1/2"

98402

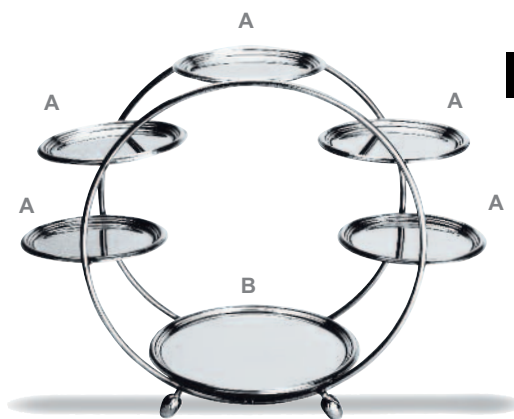

mm. 1,2 Presentoire
2 misure
2 sizes
2 tailles
2 Größen
2 tamaños

A Ø cm.13 (x5) A Ø 5 1/8" (x5)
B Ø cm.19 B Ø 7 1/2"
A Ø cm.19 (x5) A Ø 7 1/2" (x5)
B Ø cm.27 B Ø 10 5/8"



257



Porta pasticcini c/pied.
Petit-fours stand with base
Porte-petits-fours a/socle
Petits Fours-Ständer
Porta dulces con pedestal

Ø cm. 14 Ø 5 1/2"
H cm. 8,7 H 3 1/2"
Ø cm. 20 Ø 7 7/8"
H cm. 13 H 5 1/8"
Ø cm. 28 Ø 11"
H cm. 14,5 H 5 3/4"

mm. 1,2

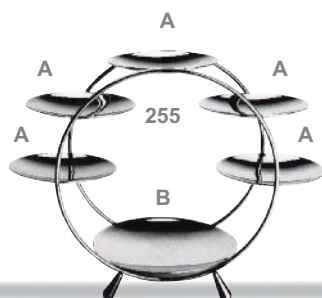

Presentoire
2 mesure
2 sizes
2 tailles
2 Größen
2 tamaños
mm. 1,2

25506
A Ø cm.6 (x5)
B Ø cm.7,5
H cm. 13
25508
A Ø cm.7,5 (x5)
B Ø cm.11
H cm. 17

25506
A Ø 2 2/5" (x5)
B Ø 3"
H 5 1/8"
25508
A Ø 3" (x5)
B Ø 4 1/3"
H 6 5/8"

258



Porta pasticcini c/pied.
Petit-fours stand w/base
Porte-petits-fours a/socle
Petits Fours-Ständer
Porta dulces c/pedestal

Ø cm. 14
Ø cm. 20
Ø cm. 28
H cm. 27
Ø 5 1/2"
Ø 7 7/8"
Ø 11"
H 10 5/8"

mm. 1,2

721



Coppa termica con cloche
Insulated cup with cloche
Coupe thermique avec cloche
Isolier-Eisfruchtbecher mit Deckel
Copa térmica con tapa

Ø cm. 8,5
cl. 15
Ø 3 3/4"
oz. 5 1/8

mm. 1,2

451



Portatoast
Toast rack
Porte-toast
Toastständer
Portatostadas

cm. 21 x 7,5
8 1/4" x 3"

mm. 1,2

935



Porta macaron
Macarons server
Porte macarons
Macaronsträger
Porta macaron

Ø cm 15
H cm 10
Ø 5 7/8"
H 4"

mm. 1,2

702



Mini burriera con coperchio
Small butter dish w/lid
Petit beurrier a/couvercle
Mini Butterdose m/Deckel
Platillo para mantequilla c/tapa

cm. 12 x 6
cl. 15
4 3/4" x 2 1/3"
oz. 5 1/8

mm. 1,2

526

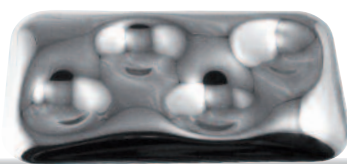

Vassoio rett. a 4 comp.
Rectang. tray 4 comp.
Plateau rect. ou 4 plac.
Tablett, rech. 4 Eins.
Bandeja rect. 4 posic.

mm. 1,2

cm. 23 x 13
9" x 5 1/8"

524



Set cremiera Koji 5pz c/vass.
Cream set Koji 5 pcs w/tray
Set à crème Koji 5 pcs a/plat.
Sahne Set 5-Tlg. Koji m/Tab.
Servicio leche Koji 5pzs. c/band.

mm. 1,2

cm. 12 x 12
cl. 25
4 3/4" x 4 3/4"
oz. 8 2/5

265



Vassoio per pasticceria
Patisserie tray
Plateau pour patisserie
Patisserie Tablett
Bandeja para pasteleria

cm. 24,5 x 17
cm. 30 x 21
cm. 34 x 24

9 5/8" x 6 3/4"
11 3/4" x 8 1/4"
13 3/8" x 9 1/2"

mm. 1,2

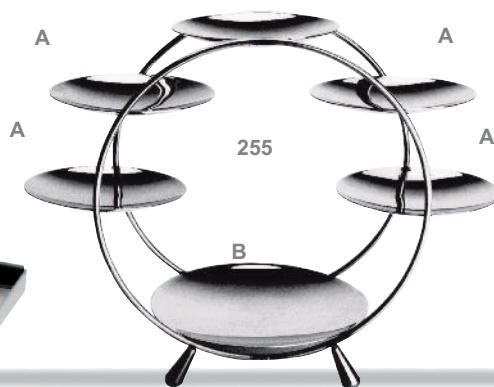

Presentoire
3 misure
3 sizes
3 tailles
3 Größen
3 tamaños

mm. 1,2

25514
A Ø cm.14 (x5)
B Ø cm.20
H cm. 30

25520
A Ø cm.20 (x5)
B Ø cm.24
H cm. 30

25524
A Ø cm.24 (x5)
B Ø cm.28
H cm. 41

25514
A Ø 5 1/2" (x5)
B Ø 7 7/8" (x5)
H 11 3/4"

25520
A Ø 7 7/8" (x5)
B Ø 9 1/2" (x5)
H 11 3/4"

25524
A Ø 9 1/2" (x5)
B Ø 11" (x5)
H 16 3/5"

205



Vassoio per pasticceria con piedistallo
Patisserie tray with foot
Plateau pour patisserie avec socle
Patisserie Tablett mit Fuss
Bandeja para pasteleria con pies

cm. 26 x 12
cm. 60 x 12
H cm. 13

10 1/4" x 4 3/4"
23 3/5" x 10 1/5"
H 5 1/9"

mm. 1,2

206

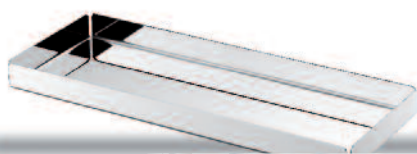

Vassoio per pasticceria
Patisserie tray
Plateau pour patisserie
Patisserie Tablett
Bandeja para pasteleria

cm. 26 x 12
cm. 60 x 12

10 1/4" x 4 3/4"
23 3/5" x 10 1/5"

mm. 1,2



Portabustine da zucchero
Sugar packet holder
Pot à sucre
Zuckerstangengefäß
Azucarera

mm. 1,2



516
cm. 10 x 7
H cm. 3

516
4" x 2 3/4"
H 1 1/8"

51610
cm. 10 x 5
H cm. 4,5

51610
4" x 2"
H 1 3/4"



Portatovaglioli
Napkin holder
Distributeur de serviettes
Serviettenhalter
Portaservilletas

cm. 13 x 13

5 1/9" x 5 1/9"

mm. 1,2

704





Caffè

621



| | | | | | |
|---------|-----------------------------|--------|---------|------------|------------|
| mm. 1,2 | Caffettiera con piedistallo | Tazze | 1 | cl. 15 | 5 1/8 oz. |
| | Coffee pot with base | Cups | 2 | cl. 27 | 9 1/8 oz. |
| | Cafetière avec socle | Bols | 4 | cl. 37 | 12 1/2 oz. |
| | Kaffeekanne auf Fuss | Tassen | 6 | cl. 55 | 18 1/8 oz. |
| | Cafetera con pedestal | Tazas | 8 | cl. 85 | 28 1/4 oz. |
| | | | 10 | cl. 110 | 37 1/4 oz. |
| | | | 12 | cl. 150 | 50 1/4 oz. |
| | | 16 | cl. 200 | 67 1/8 oz. | |

622



| | | | | | |
|---------|------------------------|--------|----|---------|------------|
| mm. 1,2 | Teiera con piedistallo | Tazze | 2 | cl. 35 | 11 7/8 oz. |
| | Tea pot with base | Cups | 4 | cl. 50 | 16 7/8 oz. |
| | Théière avec socle | Bols | 6 | cl. 70 | 23 1/8 oz. |
| | Teekanne auf Fuss | Tassen | 8 | cl. 95 | 32 1/8 oz. |
| | Tetera con pedestal | Tazas | 10 | cl. 120 | 40 7/8 oz. |
| | | | | | |

623



| | | | | | |
|---------|----------------------------|--------|---------|------------|------------|
| mm. 1,2 | Lattiera con piedistallo | Tazze | 1 | cl. 15 | 5 1/8 oz. |
| | Milk jug with base | Cups | 2 | cl. 27 | 9 1/8 oz. |
| | Pot à lait avec socle | Bols | 4 | cl. 37 | 12 1/2 oz. |
| | Milchkanne auf Fuss | Tassen | 6 | cl. 55 | 18 1/8 oz. |
| | Jarra lechera con pedestal | Tazas | 8 | cl. 85 | 28 1/4 oz. |
| | | | 10 | cl. 110 | 37 1/4 oz. |
| | | | 12 | cl. 150 | 50 1/4 oz. |
| | | 16 | cl. 200 | 67 1/8 oz. | |

624



| | | | | | |
|---------|-----------------------------|--------|---|--------|------------|
| mm. 1,2 | Zuccheriera con piedistallo | Tazze | 2 | cl. 15 | 5 1/8 oz. |
| | Sugar bowl with base | Cups | 4 | cl. 20 | 6 3/4 oz. |
| | Sucrier avec socle | Bols | 6 | cl. 27 | 9 1/8 oz. |
| | Zuckerdose auf Fuss | Tassen | 8 | cl. 35 | 11 1/8 oz. |
| | Azucarero con pedestal | Tazas | | | |
| | | | | | |

624P



646



| | | | | | |
|---------|-------------------------------------|--------|----|---------|------------|
| mm. 1,2 | Caffettiera termica con piedistallo | Tazze | 4 | cl. 30 | 10 1/8 oz. |
| | Insulated coffee pot with base | Cups | 6 | cl. 60 | 20 1/4 oz. |
| | Cafetière thermique avec socle | Bols | 12 | cl. 150 | 50 1/4 oz. |
| | Isolier-Kaffeekanne auf Fuß | Tassen | | | |
| | Cafetera térmica con pedestal | Tazas | | | |

648



| | | | | |
|---------|---|--|--|------------|
| mm. 1,2 | Caraffa termica c/fermaghiaccio e piedistallo | | | cl. 150 |
| | Insulated water pitcher w/ice-trap and base | | | |
| | Carafe à eau avec attrape-glace et socle | | | |
| | Isolier-Wasserkrug auf Fuss | | | 50 1/4 oz. |
| | Jarra agua c/tope y pedestal | | | |

641



| | | | | | |
|---------|-------------|--------|----|---------|------------|
| mm. 1,2 | Caffettiera | Tazze | 1 | cl. 15 | 5 1/8 oz. |
| | Coffee pot | Cups | 2 | cl. 27 | 9 1/8 oz. |
| | Cafetière | Bols | 4 | cl. 37 | 12 1/2 oz. |
| | Kaffeekanne | Tassen | 6 | cl. 55 | 18 5/8 oz. |
| | Cafetera | Tazas | 8 | cl. 85 | 28 3/4 oz. |
| | | | 10 | cl. 110 | 37 1/4 oz. |
| | | | 12 | cl. 150 | 50 3/4 oz. |
| | | | 16 | cl. 200 | 67 5/8 oz. |

642



| | | | | | |
|---------|----------|--------|----|---------|------------|
| mm. 1,2 | Teiera | Tazze | 1 | cl. 20 | 6 1/4 oz. |
| | Tea pot | Cups | 2 | cl. 35 | 11 7/8 oz. |
| | Théière | Bols | 4 | cl. 50 | 16 7/8 oz. |
| | Teekanne | Tassen | 6 | cl. 70 | 23 5/8 oz. |
| | Tetera | Tazas | 8 | cl. 95 | 32 1/8 oz. |
| | | | 10 | cl. 120 | 40 5/8 oz. |

643



| | | | | | |
|---------|---------------|--------|-----|---------|------------|
| mm. 1,2 | Lattiera | Tazze | 1/2 | cl. 10 | 3 5/8 oz. |
| | Milk jug | Cups | 1 | cl. 15 | 5 1/8 oz. |
| | Pot à lait | Bols | 2 | cl. 27 | 9 1/8 oz. |
| | Milchkanne | Tassen | 4 | cl. 37 | 12 1/2 oz. |
| | Jarra lechera | Tazas | 6 | cl. 55 | 18 5/8 oz. |
| | | | 8 | cl. 85 | 28 3/4 oz. |
| | | | 10 | cl. 110 | 37 1/4 oz. |
| | | | 12 | cl. 150 | 50 3/4 oz. |
| | | | 16 | cl. 200 | 67 5/8 oz. |

644



644P

| | | | | | |
|---------|-------------|--------|---|--------|------------|
| mm. 1,2 | Zuccheriera | Tazze | 2 | cl. 15 | 5 1/8 oz. |
| | Sugar bowl | Cups | 4 | cl. 20 | 6 1/4 oz. |
| | Sucrier | Bols | 6 | cl. 27 | 9 1/8 oz. |
| | Zuckerdose | Tassen | 8 | cl. 35 | 11 1/8 oz. |
| | Azucarero | Tazas | | | |

647



| | | |
|---------|---|------------|
| mm. 1,2 | Caraffa termica per acqua c/fermaghiaccio | cl. 150 |
| | Insulated water pitcher w/ice-trap | |
| | Carafe à eau avec attrape-glace | |
| | Isolier-Wasserkrug | 50 1/4 oz. |
| | Jarra agua c/tope | |

645



| | | | | | |
|---------|----------------------|--------|----|---------|------------|
| mm. 1,2 | Caffettiera termica | Tazze | 4 | cl. 30 | 10 1/8 oz. |
| | Insulated coffee pot | Cups | 6 | cl. 60 | 20 1/4 oz. |
| | Cafetière thermique | Bols | 12 | cl. 150 | 50 1/4 oz. |
| | Isolier-Kaffeekanne | Tassen | | | |
| | Cafetera térmica | Tazas | | | |

940



940E
 Inserto per art. 940
 Insert for art. 940
 Insért pour art. 940
 Einsatz für Art. 940
 Inserto por art. 940



94005



mm. 1,2 Servizio per caffè macchiato
 Café au lait set
 Service pour café au lait
 Café au lait-Set
 Juego café au lait

939
 H cm 18
 cl. 90

939
 H 7 1/8"
 oz. 30 1/2

940
 H cm 18
 cl. 97

940
 H 7 1/8"
 oz. 32 7/8

mm. 1,2 Servizio per caffè macchiato
 5pcs Sugar, milk and coffee set
 Service sucre, lait et café 5 pièces
 Milch-Kaffee-Zucker Set 5-Tlg.
 Juego leche, café y azúcar 5 piezas

H cm 18 H 7 1/8"
 cl. 30 (x5) oz. 10 1/8 (x5)

94003



mm. 1,2 Servizio per zucchero 3 pezzi
 Sugar set 3 pcs.
 Service pour sucre 3 pièces
 Zucker Menage 3-Tlg
 Juego azúcar 3 piezas

cl. 11 (x3) oz. 3 3/4 (x3)

94004



mm. 1,2 Servizio per zucchero 4 pezzi
 Sugar set 4 pcs.
 Service pour sucre 4 pièces
 Sahne-/Zucker-Set 4-Tlg
 Juego azúcar 4 piezas

cl. 11 (x4) oz. 3 3/4 (x4)

649



mm. 1,2 Bricco BOMBATA cl. 20
 Jug
 Cruche
 Milchkännchen
 Jarra

639

oz. 6 3/4

NEW



mm. 1,2 Molla per zucchero ed aperitivi
 Sugar and cocktails tongs
 Pince à sucre et apéritifs
 Zucker- und Cocktailszange
 Pinzas azúcar y aperitivos

Lungh. cm. 10,8 Length 4 1/4"

631



| | | | | |
|---------|-------------|------------|------------|------------|
| mm. 1,2 | Caffettiera | Tazze | 2 cl. 24 | 8 1/8 oz. |
| | Coffee pot | Cups | 4 cl. 34 | 11 1/2 oz. |
| | Cafetière | Bols | 6 cl. 46 | 15 1/2 oz. |
| | Kaffeekanne | Tassen | 8 cl. 63 | 21 1/8 oz. |
| | Cafetera | Tazas | 10 cl. 100 | 33 3/8 oz. |
| | | | 12 cl. 150 | 50 1/4 oz. |
| | | 16 cl. 200 | 67 1/8 oz. | |

632



| | | | | |
|---------|----------|--------|----------|------------|
| mm. 1,2 | Teiera | Tazze | 2 cl. 40 | 13 1/2 oz. |
| | Tea pot | Cups | 4 cl. 50 | 16 1/8 oz. |
| | Théière | Bols | 6 cl. 68 | 23 oz. |
| | Teekanne | Tassen | 8 cl. 90 | 30 1/2 oz. |
| | Tetera | Tazas | | |
| | | | | |

633



| | | | | |
|---------|---------------|--------|------------|------------|
| mm. 1,2 | Lattiera | Tazze | 1 cl. 10 | 3 1/8 oz. |
| | Milk jug | Cups | 2 cl. 24 | 8 1/8 oz. |
| | Pot à lait | Bols | 4 cl. 34 | 11 1/2 oz. |
| | Milchkanne | Tassen | 6 cl. 46 | 15 1/2 oz. |
| | Jarra lechera | Tazas | 8 cl. 63 | 21 1/4 oz. |
| | | | 10 cl. 100 | 33 3/8 oz. |
| | | | 12 cl. 150 | 50 1/4 oz. |
| | | | 16 cl. 200 | 67 1/8 oz. |

634



| | | | | |
|---------|-------------|--------|----------|-----------|
| mm. 1,2 | Zuccheriera | Tazze | 4 cl. 15 | 5 1/8 oz. |
| | Sugar bowl | Cups | 6 cl. 22 | 7 1/2 oz. |
| | Sucrier | Bols | 8 cl. 28 | 9 1/2 oz. |
| | Zuckerdose | Tassen | | |
| | Azucarero | Tazas | | |
| | | | | |

635



| | | |
|-------------------|------------------------------------|------------|
| mm. 1,2 | Brocca per acqua con fermagliaccio | cl. 100 |
| | Water pitcher with ice-trap | cl. 200 |
| | Carafe à eau avec attrape-glace | 33 1/5 oz. |
| | Eiswaserkrug | 67 1/3 oz. |
| Jarra agua c/topo | | |

651



mm. 1,2

| | | | | |
|-------------|--------|----|---------|------------|
| Caffettiera | Tazze | 2 | cl. 25 | 8 1/2 oz. |
| Coffee pot | Cups | 4 | cl. 37 | 12 1/2 oz. |
| Cafetière | Bols | 6 | cl. 52 | 17 1/8 oz. |
| Kaffeekanne | Tassen | 8 | cl. 70 | 23 1/8 oz. |
| Cafetera | Tazas | 10 | cl. 100 | 33 1/8 oz. |
| | | 12 | cl. 150 | 50 1/4 oz. |
| | | 16 | cl. 200 | 67 1/8 oz. |

652



mm. 1,2

| | | | | |
|----------|--------|---|--------|------------|
| Teiera | Tazze | 2 | cl. 40 | 13 1/2 oz. |
| Tea pot | Cups | 4 | cl. 55 | 18 1/8 oz. |
| Théière | Bols | 6 | cl. 70 | 23 1/8 oz. |
| Teekanne | Tassen | 8 | cl. 97 | 32 1/4 oz. |
| Tetera | Tazas | | | |

653



mm. 1,2

| | | | | |
|---------------|--------|----|---------|------------|
| Lattiera | Tazze | 1 | cl. 10 | 3 1/8 oz. |
| Milk jug | Cups | 2 | cl. 25 | 8 1/2 oz. |
| Pot à lait | Bols | 4 | cl. 37 | 12 1/2 oz. |
| Milchkanne | Tassen | 6 | cl. 52 | 17 1/8 oz. |
| Jarra lechera | Tazas | 8 | cl. 70 | 23 1/8 oz. |
| | | 10 | cl. 100 | 33 1/8 oz. |
| | | 12 | cl. 150 | 50 1/4 oz. |
| | | 16 | cl. 200 | 67 1/8 oz. |

654



mm. 1,2

| | | | | |
|-------------|--------|---|--------|------------|
| Zuccheriera | Tazze | 2 | cl. 13 | 4 1/8 oz. |
| Sugar bowl | Cups | 4 | cl. 18 | 6 1/8 oz. |
| Sucrier | Bols | 6 | cl. 22 | 7 1/2 oz. |
| Zuckerdose | Tassen | 8 | cl. 30 | 10 1/8 oz. |
| Azucarero | Tazas | | | |

361



| | | | | |
|---------|-------------|--------|------------|------------|
| mm. 1,2 | Caffettiera | Tazze | 1 cl. 10 | 3 7/8 oz. |
| | Coffee pot | Cups | 4 cl. 34 | 11 1/2 oz. |
| | Cafetière | Bols | 6 cl. 50 | 16 7/8 oz. |
| | Kaffeekanne | Tassen | 8 cl. 75 | 25 7/8 oz. |
| | Cafetera | Tazas | 10 cl. 97 | 32 1/5 oz. |
| | | | 16 cl. 200 | 67 7/8 oz. |

362



| | | | | |
|---------|----------|--------|----------|------------|
| mm. 1,2 | Teiera | Tazze | 2 cl. 35 | 11 7/8 oz. |
| | Tea pot | Cups | 4 cl. 50 | 16 7/8 oz. |
| | Théière | Bols | 6 cl. 75 | 25 7/8 oz. |
| | Teekanne | Tassen | 8 cl. 97 | 32 1/5 oz. |
| | Tetera | Tazas | | |
| | | | | |

363



| | | | | |
|---------|---------------|--------|------------|------------|
| mm. 1,2 | Lattiera | Tazze | 1 cl. 10 | 3 7/8 oz. |
| | Milk jug | Cups | 4 cl. 34 | 11 1/2 oz. |
| | Pot à lait | Bols | 6 cl. 52 | 17 7/8 oz. |
| | Milchkanne | Tassen | 8 cl. 75 | 25 7/8 oz. |
| | Jarra lechera | Tazas | 16 cl. 200 | 67 7/8 oz. |
| | | | | |

364



| | | | | |
|---------|-------------------------------|-------------|--------|-----------|
| mm. 1,2 | Zuccheriera porta bustine | 364T | | |
| | Sugar packets holder | | cl. 22 | 7 1/2 oz. |
| | Sucrier à sachets | 364A | | |
| | Zuckerdose/Zuckerstangengefäß | | cl. 22 | 7 1/2 oz. |
| | Azucarera | 364B | | |
| | | | cl. 10 | 3 7/8 oz. |

366



| | | | | |
|---------|----------------------|--------|------------|--|
| mm. 1,2 | Caffettiera termica | Tazze | 6 cl. 50 | |
| | Insulated coffee pot | Cups | 8 cl. 75 | |
| | Cafetière thermique | Bols | | |
| | Isolier-Kaffeekanne | Tassen | 16 7/8 oz. | |
| | Cafetera térmica | Tazas | 25 7/8 oz. | |
| | | | | |

367



| | | | | |
|---------|-------------------|--------|------------|--|
| mm. 1,2 | Teiera termica | Tazze | 4 cl. 50 | |
| | Insulated tea pot | Cups | 6 cl. 75 | |
| | Théière thermique | Bols | | |
| | Isolier-Teekanne | Tassen | 16 7/8 oz. | |
| | Tetera térmica | Tazas | 25 7/8 oz. | |
| | | | | |



516

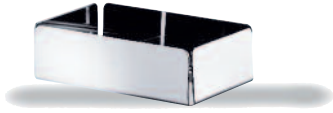

mm. 1,2 Portabustine da zucchero
Sugar packet holder
Pot à sucre
Zuckerstangengefäß
Azucarera

cm. 10 x 7 4" x 2 3/4"
H cm. 3 H 1 1/8"

206

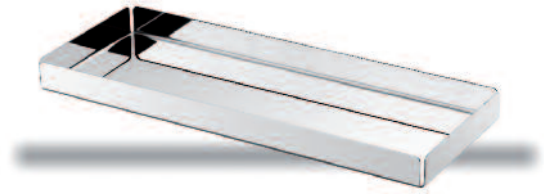

mm. 1,2 Vassoio per pasticceria
Pâtisserie tray
Plateau pour pâtisserie
Pâtisserie Tablett
Bandeja para pasteleria

cm. 26 x 12 10 1/4" x 4 3/4"
cm. 60 x 12 23 3/5" x 10 1/5"

136



mm. 1,2 Vassoio CAFE' VIENNA cm. 26 x 19 10 1/4" x 7 1/2"
Tray »
Plateau »
Kaffeetablett »
Bandeja »

704

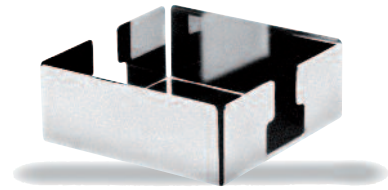

mm. 1,2 Portatovaglioli
Napkin holder
Distributeur de serviettes
Serviettenhalter
Portaservilletas

cm. 13 x 13 5 1/9" x 5 1/9"

902



mm. 1,2 Portabastoncini da zucchero
Sugar bags holder
Pot à sucre
Zuckerstangengefäß
Azucarera

Ø cm 7 H 3 1/4"
H cm 8 Ø 2 3/4"
cl. 37 oz. 12 1/2

700



mm. 1,2 Zuccheriera
Sugar container
Sucriere
Zuckerdose
Azucarero

Ø cm 10 Ø 4"
cl.35 oz 11 1/8

594



mm. 1,2 Cremlera con piedistallo UNO cl.16 oz. 5³/₈
 Cream jug with base »
 Crémier avec socle »
 Sahnegießer/Milchkännchen »
 Jarrita lechera con pedestal »

595



mm. 1,2 Zuccheriera con piedistallo UNO cl. 24 oz. 8¹/₈
 Sugar bowl with base »
 Sucrier avec socle »
 Zuckerdose auf Fuss »
 Azucarero con pedestal »

499



mm. 1,2 MINIMA cm.15 x 11 5⁷/₈" x 4³/₈"
 Portabustine da zucchero 4 sc. H.cm.14 H. 5¹/₂"
 Sugar packets holder 4 compt.
 Pot à sucre 4 comp.
 Zuckerstangengefäß 4 Eins.
 Azucarera 4 comp.

706



mm. 1,2 Porta salviette lavamani cm. 15 x 9 5⁷/₈" x 3¹/₂"
 Tray for hand towels
 Plateau porte serviettes
 Tablett für Stoffservietten
 Bandeja portaservilletas

703



10201144
 Lungh. cm. 16,5
 Length 6¹/₂"

mm.1,2 Set per latte macchiato Ø cm. 10 Ø 3⁷/₈"
 Latte Macchiato Set cl. 36 oz. 12³/₈
 Service pour Latte Macchiato
 Latte Macchiato-Set
 Servicio para café con leche

720



mm. 1,2 Portaburro e marmellata cm. 17,5 x 7,5 6⁷/₈" x 3"
 Butter and jam dish
 Beurre et confiture
 Butter-Marmeladen-Platte
 Porta mantequilla y mermelada

Bar



941

661

665



Portacucchiaini per bar Ø cm. 9 Ø 3 1/4"
Coffee spoons stand
Pot à cuillères pour bar
Löffelbecher
Porta-cucharitas para bar
mm. 0,8

Secchiello per spumante Ø cm. 18 Ø 7 1/4"
Sparkling wine cooler H cm. 18,5 H 7 1/8"
Seau à champagne lt. 4 gal. 1
Wein- und Sektkühler
Cubo para champany
mm. 1,2

Secchiello per ghiaccio Ø cm. 13,5 Ø 5 1/8"
Ice-bucket with knobs H cm. 13 H 5 1/8"
Seau à glaçons cl. 150 oz. 50 1/4
Eisgefäß
Cubitera hielo
mm. 0,8

708

545



mm. 1,2 Piattino portamonete
Cash tray
Plat à addition
Zahlteiler
Bandeja porta monedas

cm. 11 x 15 4 1/8" x 5 1/8"

mm. 1,2 Dosatore
Jigger
Doseur
Barmaß
Medida

cl. 2 e 4 oz. 1
oz. 1 1/8

Agitatore cl. 25 oz. 8 1/2
Shaker cl. 50 oz. 16 1/8
Shaker cl. 75 oz. 25 1/8
Shaker
Coctelera

729

551



mm. 1,2 Coppa per punch Ø cm. 38
Punch bowl lt. 15
Bol à punch
Punchbowl Ø 15"
Cazo ponche 4 gal.

Mestolo coppa per punch
Punch bowl ladle
Cuiller à punch
Bowlenlöffel
Cazo ponche

mm. 0,8

Agitatore Boston con bicchiere
Boston shaker
Boston shaker à cocktail et verre
Boston Shaker
Coctelera Boston

cl. 75 oz. 25 1/8

Colori disponibili a pag. 344
Available colors at page 344
Couleurs disponibles
à page 344
Sehen Sie erhaltlichen Farben
an Seite 344
Ver colores à pagina 344

972

973



972

973

973P

972P

mm. 1,2
972-972P
PALACE
 Secchiello per ghiaccio
 Ice bucket
 Seau à glaçons
 Eisgefäß
 Cubitera hielo

Ø cm 15 Ø 5¹/₈"
 H cm 18 H 7¹/₈"
 cl.150 oz. 50³/₄

mm. 1,2
973-973P
PALACE
 Secchiello per spumante
 Sparkling wine cooler
 Seau à champagne
 Wein- und Sektkühler
 Cubo para champany

Ø cm 20,5 Ø 8¹/₈"
 H cm 24,5 H 9⁵/₈"
 lt. 5,0 gal. 1¹/₃

666F

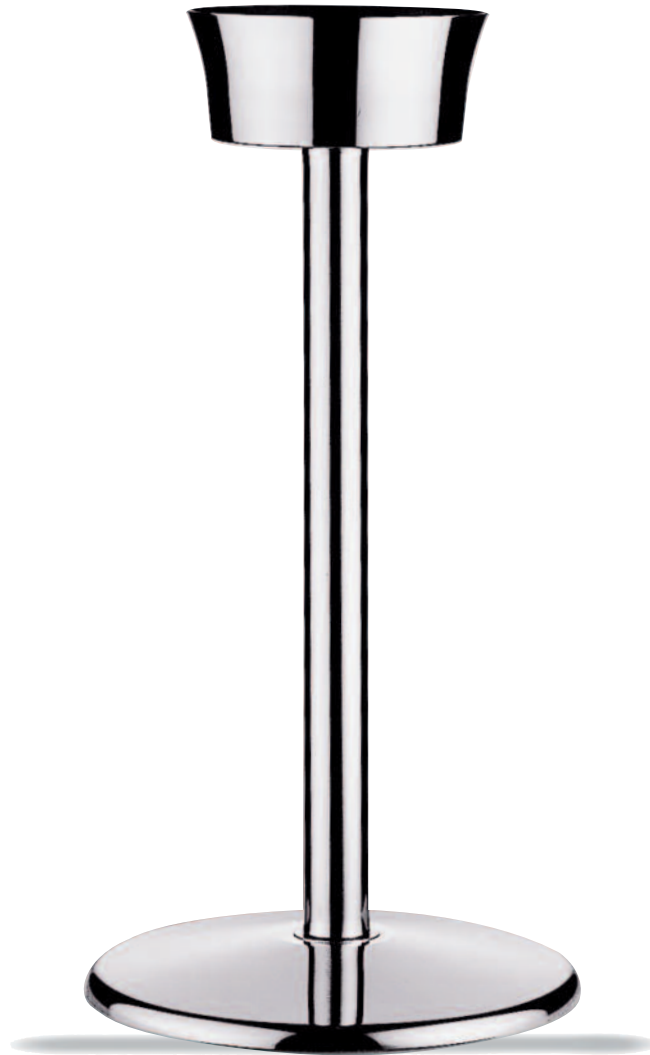

mm. 1,2
PALACE
 Colonna portasecchiello spumante
 Wine cooler stand w/weighted base
 Pied pour seau à champagne
 Weinkühlerständer
 Columna porta cubo champany

H cm. 67,5 H 26⁵/₈"

370



mm. 1,2 IMMAGINA
 Secchiello per spumante
 Sparkling wine cooler
 Seau à champagne
 Wein- und Sektkühler
 Cubo para champany

cm 27 x 20,5 10 5/8" x 8"
 H cm 21,5 H 8 1/2"
 lt. 6,5 gal. 1 3/4

371



mm. 1,2 IMMAGINA
 Secchiello per ghiaccio
 Ice bucket
 Seau à glaçons
 Eisgefäß
 Cubitera para hielo

cm 16,6 x 10 6 1/2" x 4"
 H cm 14,2 H 8 1/2"
 cl. 180 oz. 60 7/8

666H



mm. 1,2 IMMAGINA
 Colonna portasecchiello spumante
 Wine cooler stand
 Pied pour seau à champagne
 Weinkühlerständer
 Columna porta cubo champany

H cm. 61,5 H 24 1/5"

670



670 mm. 1,2
 Secchiello per ghiaccio
 Ice bucket with grill
 Seau à glaçons
 Eisgefäß
 Cubitera hielo
 Ø cm. 14 - H cm. 13 - cl. 150
 Ø 5 1/2" - H 5 1/8" - oz. 50 3/4



662 mm. 1,2
 Rinfrescavino bianco da 1 bottiglia
 White wine cooler for 1 bottle
 Seau à vin blanc
 Weissweinkühler für 1 Flasche
 Cubo para refrescar 1 botella de vino blanco
 Ø cm. 16 - H cm. 20 - lt. 3
 Ø 6 1/4" - H 7 7/8" - oz. 101 1/2



663 mm. 1,2
 Rinfrescavino spumante da 1 bottiglia
 Sparkling wine cooler for 1 bottle
 Seau à Champagne 1 bouteille
 Champagnerkühler für 1 Flasche
 Cubo para refrescar 1 botella de vino spum.
 Ø cm. 18 - H cm. 21 - lt. 4,5
 Ø 7 1/8" - H 8 1/4" - gal. 1 1/4



664 mm. 1,2
 Rinfrescavino spumante da 2/3 bottiglie o Magnum
 Sparkling wine cooler for 2/3 bottles or Magnum
 Seau à champagne 2/3 bouteilles ou Magnum
 Champagnerkühler für 2/3 Flaschen oder Magnum
 Cubo para refrescar 2/3 botellas de vino spumante
 Ø cm. 22,5 - H cm. 23 - lt. 8,5
 Ø 8 7/8" - H 9" - gal. 2 1/4

664

666

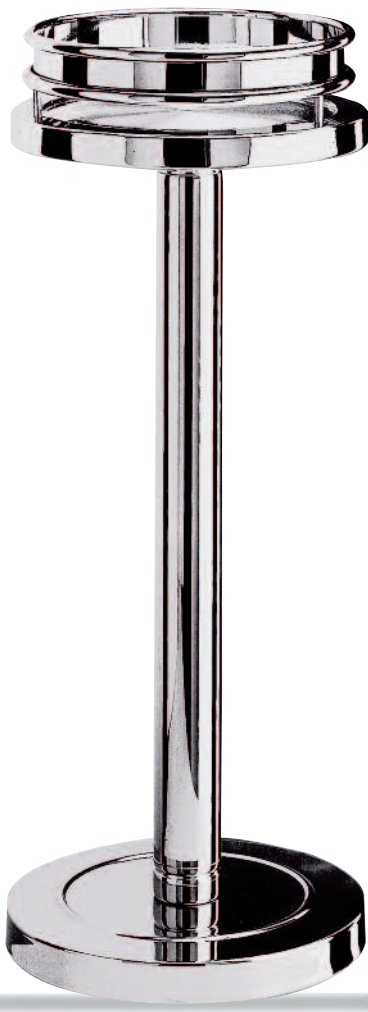

mm. 1,2
 Colonna portasecchiello spumante
 Wine cooler stand
 Pied pour seau à champagne
 Weinkühlerstand
 Columna porta cubo champany
 H cm. 65 H 25 5/8"

67704



mm. 0,8
 Portaghiaccio termico con coperchio
 Insulated ice-bucket with lid
 Seau à glaçon thermique avec couvercle
 Isolier-Eisgefäß
 Cubitera hielo con tapa
 lt. 3/4
 lt. 4
 oz. 25 3/8
 gal. 1

67701

676



mm. 0,8
 Glacette termica per 1 bottiglia
 Insulated glacette for 1 bottle
 Glacette thermique pour 1 bouteille
 Getränkekühler 1 Flasche
 Cubo térmico para 1 botella
 Ø cm. 13
 H cm. 20
 cl. 150
 Ø 5 1/8"
 H 7 7/8"
 oz. 50 3/4

681

678



681 mm.1,2
MICHELANGELO
 Rinfrescavino spumante da 2/3 bottiglie o Magnum
 Sparkling wine cooler for 2/3 bottles or Magnum
 Seau à champagne 2/3 bouteilles ou Magnum
 Champagnerkühler für 2/3 Flaschen oder Magnum
 Cubo para refrescar 2/3 botellas de vino spumante
 Ø cm.22,5 - H cm.23 - lt. 8,5
 Ø 8 7/8" - H 9" - gal. 2 1/4

680 mm.1,2
MICHELANGELO
 Rinfrescavino spumante da 1 bottiglia
 Sparkling wine cooler for 1 bottle
 Seau à champagne 1 bouteille
 Champagnerkühler für 1 Flasche
 Cubo para refrescar 1 botella de vino spum.
 Ø cm.18 - H cm.21 - lt. 4,5
 Ø 7 1/8" - H 8 1/4" - gal. 1 1/4

679 mm.1,2
MICHELANGELO
 Rinfrescavino bianco da 1 bottiglia
 White wine cooler for 1 bottle
 Seau à vin blanc
 Weissweinkühler für 1 Flasche
 Cubo para refrescar 1 botella de vino blanco
 Ø cm.16 - H cm.20 - lt. 3
 Ø 6 1/4" - H 7 7/8" - oz. 10 1/2

678 mm.1,2
MICHELANGELO
 Secchiello per ghiaccio
 Ice bucket with grill
 Seau à glaçons
 Eisgefäß
 Cubitera hielo
 Ø cm.14 - H cm.13 - cl. 150
 Ø 5 1/2" - H 5 1/8" - oz. 50 3/4

672

666A



mm. 1,2 Portaggiaccio termico con anello e molla
 Insulated ice-bucket with handle and tongs for ice
 Seau à glaçon thermique avec anse et pinçe
 Isolier-Eisgefäß und Eiszange
 Cubitera hielo con asa y pinzas hielo
 lt. 3/4 oz. 25 3/8

660



mm. 0,8 Servizio per champagne
 Insulated Champagne set
 Service pour champagne
 Champagnergetränk cooler
 Servicio para champagne
 Ø cm. 26
 H cm. 22
 cl. 150
 Ø 10 1/4"
 H 8 2/3"
 oz. 50 3/4

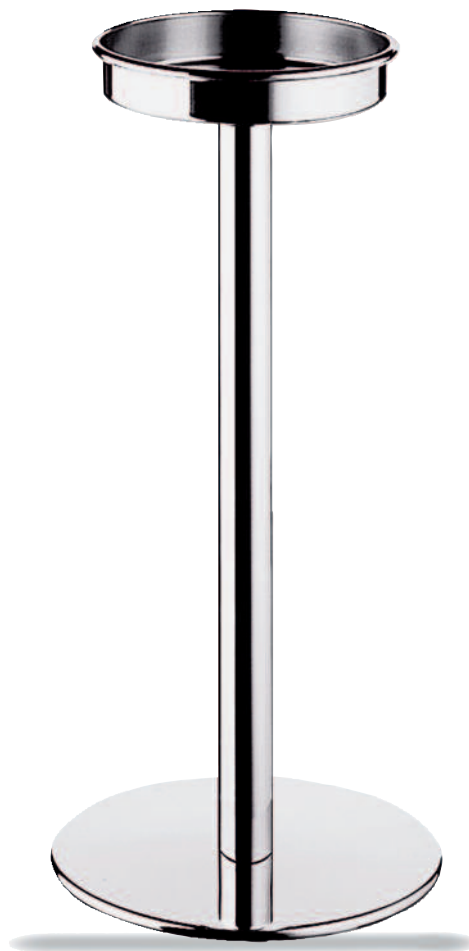

mm. 1,2 GALA
 Colonna portasecchiello spumante
 Wine cooler stand
 Pied pour seau à champagne
 Weinkühlerständer
 Columna porta cubo champany
 H cm. 60
 H 23 3/8"

67301



67304



mm. 1,2 GIOTTO
Portaghiaccio termico con coperchio
Insulated ice-bucket with lid
Seau à glaçons thermique
avec couvercle
Isolier-Eisgefäß
Cubitera hielo con tapa

Ø cm 14 Ø 5 1/2"
H cm 13 H 5"
cl.72 oz. 24 1/3

Ø cm 24 Ø 9 1/2"
H cm 22 H 8 5/8"
lt. 4,0 gal. 1

669



668

mm. 1,2 GIOTTO
Secchiello spumante e ghiaccio
Sparkling wine cooler / Ice bucket
Seau à champagne et à glaçons
Wein- Sektkühler / Eisgefäß
Cubo para champany y para hielo

Ø cm 24 Ø 9 1/2"
H cm 23 H 9"
lt. 5,0 gal. 1 1/3

Ø cm 14,5 Ø 5 2/3"
H cm 13 H 5 1/9"
lt. 1,4 oz. 47 1/3

666E

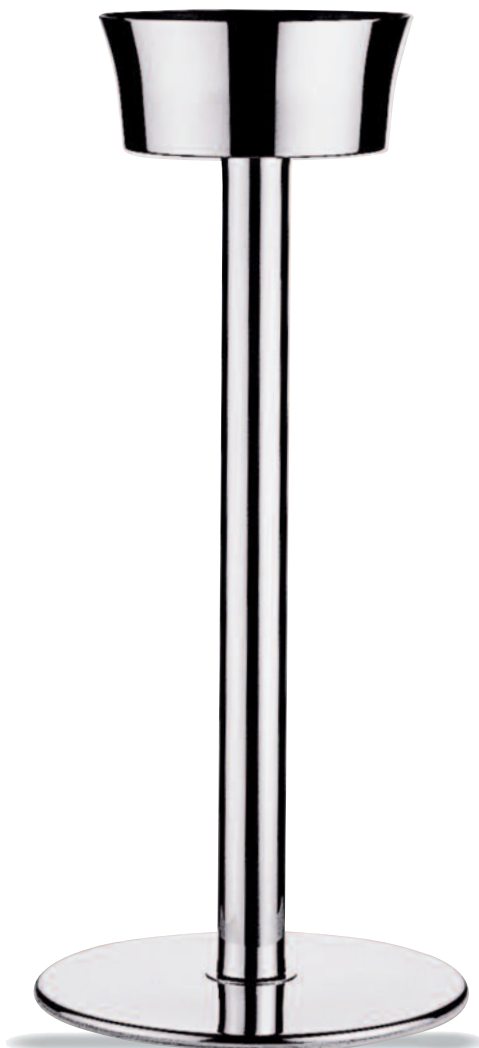

mm. 1,2 GIOTTO
Colonna portasecchiello spumante
Wine cooler stand
Pied pour seau à champagne
Weinkühlerständer
Columna porta cubo champany

H cm. 67,5 H 26 5/8"

948



mm. 1,2 LESS IS MORE
Rinfrescavino spumante da 3 bottiglie o 2 Magnum
Sparkling wine cooler for 3 bottles or 2 Magnum
Seau à champagne 3 bouteilles ou 2 Magnum
Champagnerkühler für 3 Flaschen oder 2 Magnum
Cubo para refrescar 3 botellas de vino spumante

cm. 35 x 15
H cm. 18
lt. 9

13 3/4" x 5 7/8"
H 7 1/8"
gal. 2 1/2

430



mm. 1,2 FASHION
Rinfrescavino spumante da 2 bottiglie o Magnum
Sparkling wine cooler for 2 bottles or Magnum
Seau à champagne 2 bouteilles ou Magnum
Champagnerkühler für 2 Flaschen oder Magnum
Cubo para refrescar 2 botellas de vino spumante

H cm. 21
cm. 21 x 21
lt. 9

H 8 1/4"
8 1/4" x 8 1/4"
gal. 2 1/2

666M

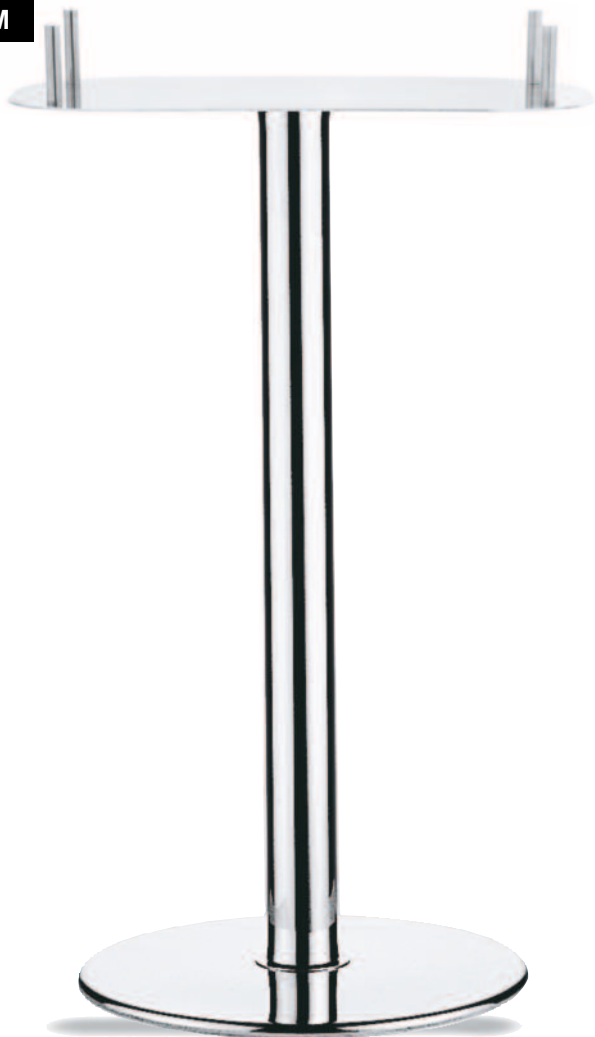

mm. 1,2 LESS IS MORE
Colonna portasecchiello spumante
Wine cooler stand
Pied pour seau à champagne
Weinkühlerständer
Columna porta cubo champany

H cm. 62
cm. 38 x 25

H 24 2/5"
15" x 9 7/8"

666L

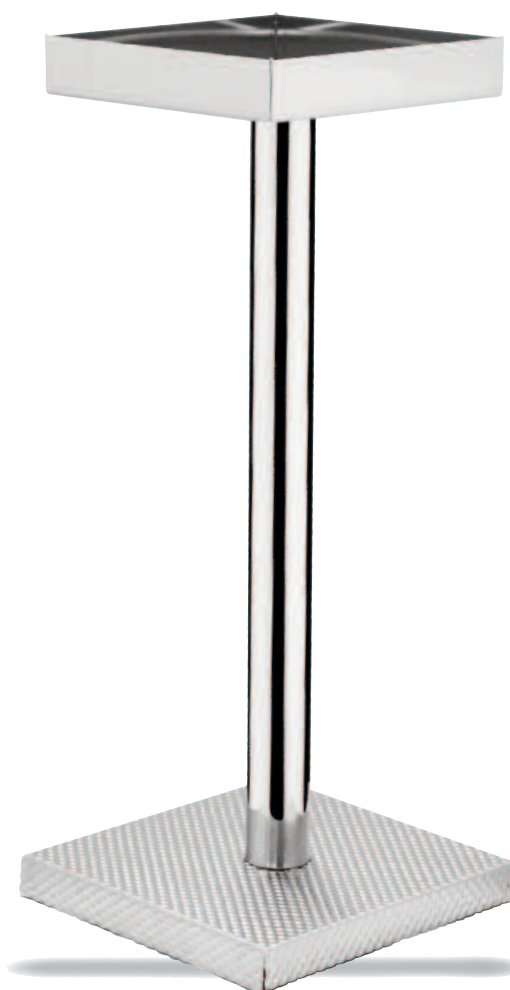

mm. 1,2 FASHION
Colonna portasecchiello spumante
Wine cooler stand
Pied pour seau à champagne
Weinkühlerständer
Columna porta cubo champany

H cm. 61,5 H 24 1/5"

597



mm. 1,2 UNO
 Secchiello per ghiaccio
 Ice bucket
 Seau à glaçons
 Eisgefäß
 Cubitera hielo

Ø cm. 16,8 Ø 6 5/8"
 H cm. 11 H 4 3/8"
 cl. 150 oz. 50 3/4

598



mm. 1,2 UNO
 Secchiello per spumante
 Sparkling wine cooler
 Seau à champagne
 Wein- und Sektkühler
 Cubo para champany

Ø cm. 29 Ø 11 3/8"
 H cm. 18,5 H 7 1/4"
 lt. 8 gal. 2

666W

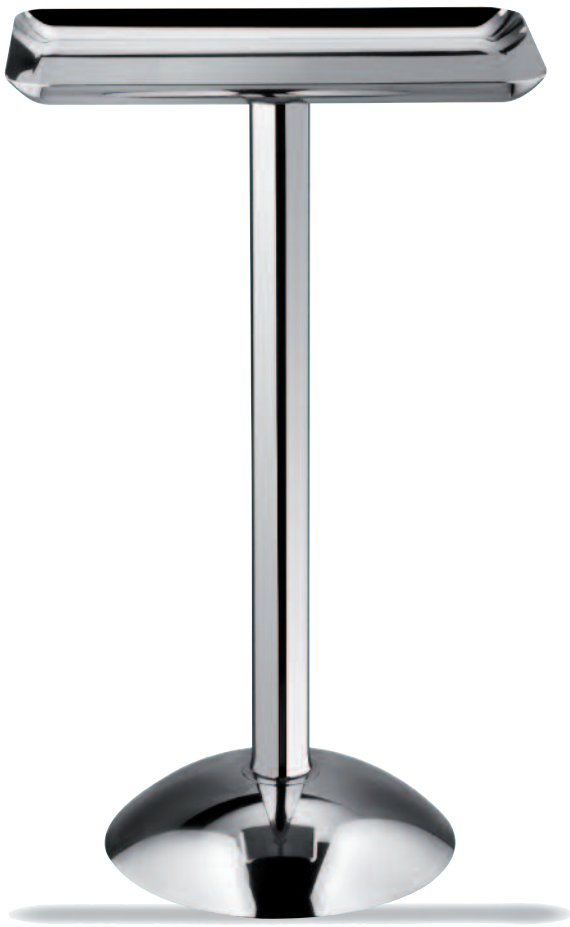

mm. 1,2 Gueridon d'appoggio rettangolare H cm. 62 H 24 2/5"
 Rectangular gueridon cm. 38 x 25 15" x 9 7/8"
 But de canapé rectangulaire
 Gueridon, rechteckig
 Gueridon rectangular

666Z



mm. 1,2 Gueridon d'appoggio ovale H cm. 62 H 24 2/5"
 Oval gueridon cm. 46 x 31 18 1/8" x 12 1/4"
 But de canapé oval
 Gueridon, oval
 Gueridon oval

599



mm. 1,2 UNO
 Secchiello per spumante
 Sparkling wine cooler
 Seau à champagne
 Wein- und Sektkühler
 Cubo para champany

Ø cm. 29 Ø 11 3/8"
 H cm. 18,5 H 7 1/4"
 lt. 8 gal. 2

589



Ciotola tonda
 Round bowl
 Bol ronde
 Fruchtekorb rund
 Cuenco redondo

Ø cm. 28 Ø 11"
 H cm. 17,3 H 6 5/8"
 lt. 6,03 qt. 6 1/3

599

58928

7 colori disponibili - pag. 312 - 313
 7 colors available - pages 312 - 313
 7 couleurs disponibles - pag. 312 - 313
 7 verschiedenen Farben verfügbar - Seiten 312 - 313
 7 colores disponibles - pag. 312 - 313

589 - Ø cm. 28
 Ø 11"



666C

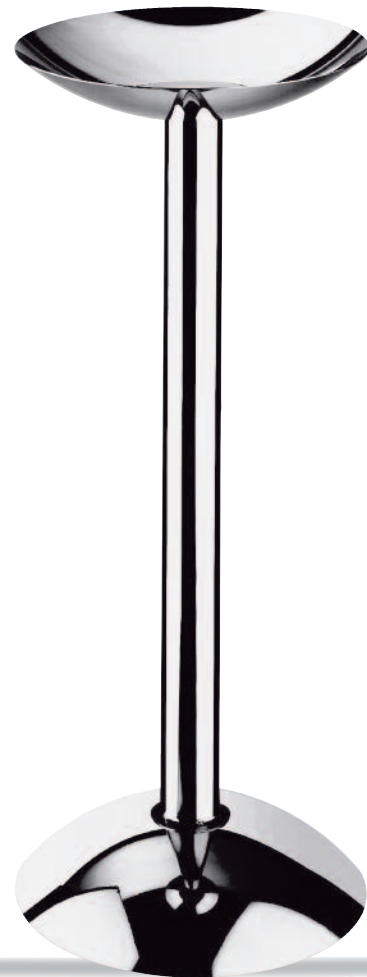

mm. 1,2 UNO H cm. 67,5 H 26 5/8"
 Colonna portasecchiello spumante
 Wine cooler stand
 Pied pour seau à champagne
 Weinkühlerständer
 Columna porta cubo champany

598

59870

Logo traforato a richiesta
 Fretworked logo on demand
 Logo ajourée sur demande
 Firmenzeichen gelocht auf Verlangen
 Logo perforado en demanda

589 - Ø cm. 64
 Ø 25 1/4"

589 - Ø cm. 28
 Ø 11"



598
 mm. 1,2 Secchiello Ø cm. 29 Ø 11 3/8"
 Basket H cm. 18,5 H 7 1/4"
 Corbeille lt. 8 gal. 2
 Fruchtkorb
 Cesta

59870
 mm. 1,2 Big Champagnera Ø cm. 67,5 Ø 26 3/8"
 Champagne bowl H cm. 43 H 17"
 Bol a champagne lt. 80 gal. 21
 Champagner Bowl
 Cesta para champany

666K



NEW

mm. 1,2 Colonna porta big champagnera H cm. 51 H 20"
Champagne bowl stand
Pied pour bol a champagne
Champagner Bowlständer
Columna porta cesta champany

A



Ambra
Amber
Amber
Amber
Ambar



G



Granato
Garnet
Grenat
Granat
Granate

M



Ametista
Amethyst
Amethyste
Amethyst
Amatista

W



Trasparente
Transparent
Glace
Transparent
Vidrio

Z



Zaffiro
Saphyre
Saphir
Saphir
Zafiro

S



Smeraldo
Emerald
Emeraude
Smaragd
Esmeralda

O



Onice
Onyx
Onyx
Onyx
Onice

909



mm. 1,2 Secchiello per ghiaccio forato
Ice bucket fretworked handles
Seau à glaçons anses ajourée
Eisgefäß mit Griffen
Cubitera hielo asa perforada

cm. 22 x 20 8 3/4" x 7 7/8"
H cm. 11,5 H 4 5/8"
lt. 1,2 oz. 40 1/2

912



mm. 1,2 Secchiello per spumante forato
Sparkling wine cooler fretw. handles
Seau à champagne anses ajourée
Wein- und Sektkühler mit Griffen
Cubo para champany asa perforada

cm. 39 x 36 15 3/8" x 14 1/4"
H cm. 17,5 H 7"
lt. 7 gal. 1 4/5

730



mm. 1,2 Spumantiera 12 bottiglie champagne
Giant champagne bucket for 12 bottles
Seau à champagne géante pour 12 bouteilles
Champagner Bowl für 12 Flaschen
Cubo de champagne gigante para 12 botellas

cm. 75 x 65 29 1/2" x 25 5/8"
H cm. 19 H 7 1/2"
lt. 15 gal. 3 7/8

899



mm. 1,2 Secchiello per ghiaccio
Ice bucket
Seau à glaçons
Eisgefäß
Cubitera hielo

cm. 22 x 20 8 3/4" x 7 7/8"
H cm. 11,5 H 4 5/8"
lt. 1,2 oz. 40 1/2

910



mm. 1,2 Secchiello per spumante
Sparkling wine cooler
Seau à champagne
Wein- und Sektkühler
Cubo para champany

cm. 39 x 36 15 3/8" x 14 1/4"
H cm. 17,5 H 7"
lt. 7 gal. 1 4/5

686



mm. 1,2 Champagnera 5 bott. c/pied. Ø cm. 40 Ø 15 3/4"
 Giant Champagne bucket 5 bot. H cm. 38,5 H 15 1/6"
 Seau à champagne p/5 bott. lt. 15 gal. 4
 Champagner Bowl 5 Fläsche
 Cubo de champagne p/5 bot.

685



mm. 1,2 Champagnera 5 bott. s/pied. Ø cm. 40 Ø 15 3/4"
 Giant Champagne bucket 5 bot. H cm. 21,8 H 8 3/5"
 Seau à champagne p/5 bott. lt. 15 gal. 4
 Champagner Bowl 5 Fläsche
 Cubo de champagne p/5 bot.

666I



mm. 1,2 Colonna portabottiglie spumante H cm. 78 H 30 5/7"
 Wine cooler stand
 Pied pour seau à champagne
 Weinkühlerständer
 Columna porta cubo champany

674



mm. 1,2 Spumantiera termica 5 bott. s/pied. Ø cm. 40 Ø 15 3/4"
 Giant insulated Champagne bucket 5b. H cm. 21,8 H 8 3/5"
 Seau à champagne thermique p/5 bou. lt. 15 gal. 4
 Isolier Champagner Bowl 5 Fläsche
 Cubo térmico para champagne p/5 bot.

380



382
Lungh. cm. 17,5
Length 6⁷/₈"

mm. 1,5

mm. 1,2

ERGONOMICA
Secchiello e molla per ghiaccio
Ice bucket and ice tongs
Seau à glaçons et pince à glaçons
Eisgefäß und Eiszange
Cubitera hielo y pinzas hielo

cl. 200

oz. 67 ⁵/₈

381



mm. 1,2

ERGONOMICA
Secchiello per spumante
Sparkling wine cooler
Seau à champagne
Wein-und Sektkühler
Cubo para champany

lt. 4,5

gal. 1¹/₄

683



mm. 1,2

Secchio per ghiaccio
Ice bucket with grill
Seau à glaçons
Eisgefäß
Cubitera hielo

Ø cm.14 Ø 5¹/₂"
H.cm.13 H. 5¹/₈"
cl. 150 oz. 50³/₄

684



mm. 1,2

Secchio per spumante
Sparkling wine cooler
Seau à champagne
Wein-und Sektkühler
Cubo para champany

Ø cm.23 Ø 9"
H cm.22,5 H 8⁷/₈"
lt. 8,5 gal. 2¹/₄

941



mm. 1,2

Portacannucce
Straw holder
Porta pailles
Strohalm Halter
Porta-palillas

Ø cm. 9 Ø 3 ¹/₄"

10001150



mm. 1,2

Golf club mixer spoon
Golf club mixer spoon
Golf crosse pour cocktail
Golf Schleger für Long drink
Golf club cucharita coctél

cm. 16,5 6 ¹/₂"

438

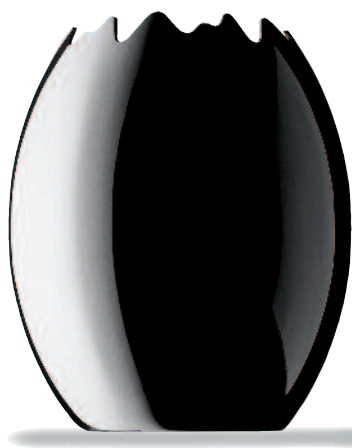

mm. 1,2

OVO
Secchiello per spumante
Sparkling wine cooler
Seau à champagne
Wein- und Sektkühler
Cubo para champany

Ø cm. 19 Ø 7 1/2"
H cm. 22 H 8 5/8"
lt. 4,5 gal. 1 1/4

439



mm. 1,2

OVETTO
Secchiello per ghiaccio
Ice-bucket
Seau à glaçons
Eisgefäß
Cubitera hielo

Ø cm. 11 Ø 4 3/8"
H cm. 13 H 5 1/8"
cl. 100 oz. 33 7/8

689



mm. 1,2

Secchiello per spumante
Sparkling wine cooler
Seau à champagne
Wein- und Sektkühler
Cubo para champany

Ø cm. 19 Ø 7 1/2"
H cm. 20 H 7 3/4"
lt. 2,5 oz. 84 1/2

688



mm. 1,2

Secchiello per ghiaccio
Ice-bucket
Seau à glaçons
Eisgefäß
Cubitera hielo

Ø cm. 11 Ø 4 3/8"
H cm. 12,5 H 4 7/8"
cl. 55 oz. 18 5/8

658



Cubetto luminoso confez. 72 pezzi cm. 2,5 x 2,5 1" x 1"
LED ice cube 72 pcs. box H cm. 2,5 H 1"
Glaçons lumineux 72 pièces
Eiswürfel LED 72 Stücke
Cubito hielo LED 72 piezas

Idoneo al contatto con gli alimenti.

Suitable for contact with food

Materiale certificato:
LFGB - German Food, Commodities and Animal Feed Code of Law
DIN 10955 - 2004
ISO 11885:2007
BfR Recommendations on Food Contact Materials - part V & VI 2010 & 2010
Regolamento CEE (EU) 10/2011
Regolamento CEE (EC) 1907/2006
Regolamento CEE (EC) 1935/2004

Certified material:
LFGB - German Food, Commodities and Animal Feed Code of Law
DIN 10955 - 2004
ISO 11885:2007
BfR Recommendations on Food Contact Materials - part V & VI 2010 & 2010
Regulation CEE (EU) 10/2011
Regulation CEE (EC) 1907/2006
Regulation CEE (EC) 1935/2004

Durata delle batterie: 12 ore

Battery life: 12 hours

Front Cooking



FRONT COOKING

- Design e performance tecniche combinati alla perfezione
 - Adatte a tutte le fonti di calore e cottura
 - Manici ergonomici
 - Progettate in collaborazione con i più importanti produttori di cucine professionali per far rendere al meglio fuochi ed induzione
-
- Perfect combination of technical performance and design.
 - Suitable for all hobs.
 - Ergonomic handles.
 - Projected in cooperation with the most important manufacturers of professional kitchens, in order to perform hobs and induction at their best.
-
- Design et performance techniques combinées à la perfection
 - Aptes à toutes les font de chaleur et de cuisson
 - Poignées ergonomiques
 - Conçues en collaboration avec les principaux producteurs de cuisines professionnelles afin de rendre les feux et l'induction plus performants.
-
- Perfekte Kombination aus technische Leistung und Design.
 - Für alle Kochfelder geeignet.
 - Ergonomische Griffe.
 - Projektiert in Zusammenarbeit mit den wichtigsten Hersteller von Profiküchen, um Kochfelder und Induktion optimal zur Geltung zu bringen.
-
- Perfecta combinación de prestaciones técnicas y Design.
 - Apto para todas las placas.
 - Asas ergonómicas.
 - Proyectado en cooperación con los más importantes fabricantes de cocinas profesionales, con el fin de realizar las mejores cocinas e inducción.

MEPRA
S.p.A.

Apartments

APARTMENTS

- Design differenti per ogni tipo di stile
- Alte performance su tutti i piani di cottura
- Manici ergonomici ad alta resistenza al calore
- Vasto assortimento di misure

- Different Design for any kind of style.
- High performance on every hobs.
- Heat resistant ergonomic handles.
- Wide assortment of sizes.

- Différents designs pour chaque style
- Hautes performances sur tous les fonds de cuisson
- Poignées ergonomiques à haute résistance à la chaleur
- Large assortiment de tailles.

- Unterschiedliches Design für jeden Stil.
- Höchste Leistung auf allen Kochfeldern.
- Hitzebeständig ergonomisch Griffe.
- Breites Sortiment an Größen.

- Design diferente para cualquier tipo de estilo.
- Alto rendimiento en todas las placas.
- Mangos ergonómicos, resistentes al calor.
- Amplia variedad de tallas.







Acciaio Inossidabile 18/10, cuore in alluminio, esterno in acciaio per induzione
 Superficie esterna ed interna lucidate a specchio
 Maniglie con rivetti in acciaio inossidabile 18/10, a tenuta rinforzata
 Il calore si distribuisce uniformemente su tutta la superficie della pentola
 Maggiore controllo della temperatura di cottura
 Notevole risparmio di energia e tempo
 Minor alterazione delle vitamine e proteine durante la cottura

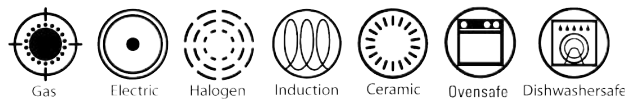

18/10 Stainless Steel, aluminum core, Induction Steel outside
 Mirror polished surfaces, outside and inside
 Handles with strongly fixed 18/10 Stainless Steel rivets,
 The heat is distributed evenly over the surface of the pot
 Greater control of cooking temperature
 Considerable saving of energy and time
 Minor alteration of vitamins and proteins during cooking

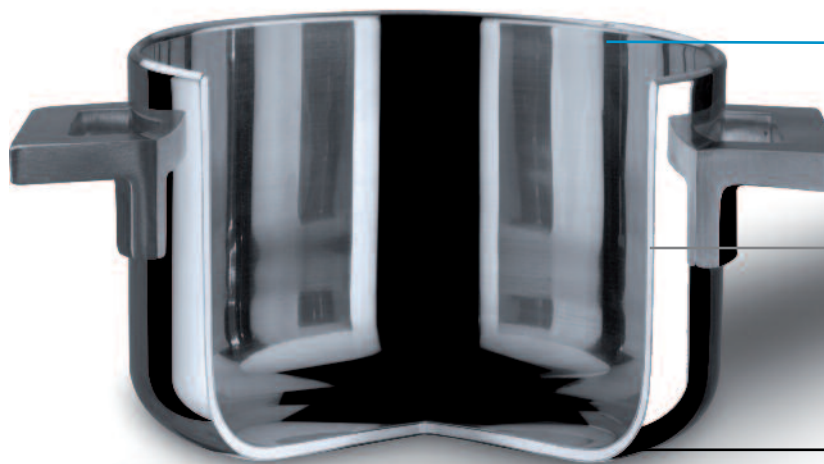

Strato interno - Inner layer

Acciaio Inossidabile 18/10 - Il materiale in assoluto più igienico e più facile da pulire
 Stainless Steel 18/10 - The material even more hygienic easier to clean

Strato centrale - Middle layer

Cuore in alluminio - Il materiale leggero, non soggetto a corrosione ed atossico
 Aluminum core - The lightweight, non-corrosive and non-toxic

Strato esterno - Outer layer

Acciaio speciale per induzione
 Special steel for induction



1831

Risottiera e tegame per arrosti e brasati in **Trimetallo** con interno in acciaio inossidabile 18/10 senza rivestimento
Tri-ply Low casserole for risotto and stews.

Ø cm. 24 - Lt. 3,0
 Ø cm. 28 - Lt. 4,0

Ø 9 1/2" - Qt. 3 1/6
 Ø 11" - Qt. 4 1/5



1821

Sauteuse per condimenti e salse in **Trimetallo** con interno in acciaio inossidabile 18/10 senza rivestimento
Tri-ply Casserole for serving sauces, soups and side dishes.

Ø cm. 18 - Lt. 2,0
 Ø cm. 20 - Lt. 3,0
 Ø cm. 22 - Lt. 3,5
 Ø cm. 24 - Lt. 5,0

Ø 7" - Qt. 2 1/9
 Ø 7 1/8" - Qt. 3 1/6
 Ø 8 2/3" - Qt. 3 2/3
 Ø 9 1/2" - Qt. 5 1/3



1801

Pentola in **Trimetallo** con interno in acciaio inossidabile 18/10 senza rivestimento
Tri-ply Deep pot

Ø cm. 20 - Lt. 3,5
 Ø cm. 22 - Lt. 5,0
 Ø cm. 24 - Lt. 6,5

Ø 7 7/8" - Qt. 3 2/3
 Ø 8 2/3" - Qt. 5 1/3
 Ø 9 1/2" - Qt. 6 1/8



1811

Mini casserole per soufflé, condimenti e salse in **Trimetallo** con interno in acciaio inossidabile 18/10 senza rivestimento
Tri-ply Mini casseroles for soufflé, condiments and sauces

Ø cm. 9 - Lt. 0,25
 Ø 3 1/2" - Qt. 1/11
 Ø cm. 14 - Lt. 1,0
 Ø 5 1/2" - Qt. 1
 Ø cm. 16 - Lt. 2,0
 Ø 6 1/3" - Qt. 2 1/9



1821

Mini casserole per soufflé, condimenti e salse in **Trimetallo** con interno in acciaio inossidabile 18/10 senza rivestimento
Tri-ply Mini casseroles for soufflé, condiments and sauces

Ø cm. 12 - Lt. 0,6
 Ø 4 2/3" - Qt. 1/11



1841
Padella in **Trimetallo**
Tri-ply Frying pan
Poêle à frire
Bratpfanne
Sartén

| | |
|----------|------------------------------------|
| Ø cm. 22 | Ø 8 ² / ₃ " |
| Ø cm. 26 | Ø 10 ¹ / ₄ " |
| Ø cm. 30 | Ø 11 ³ / ₄ " |

Acciaio Inossidabile 18/10, cuore in alluminio, esterno in acciaio per induzione
 Superficie esterna ed interna lucidate a specchio
 Maniglie con rivetti in acciaio inossidabile 18/10, a tenuta rinforzata
 Il calore si distribuisce uniformemente su tutta la superficie della pentola
 Maggiore controllo della temperatura di cottura
 Notevole risparmio di energia e tempo
 Minor alterazione delle vitamine e proteine durante la cottura

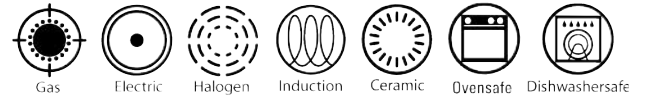

18/10 Stainless Steel, aluminum core, Induction Steel outside
 Mirror polished surfaces, outside and inside
 Handles with strongly fixed 18/10 Stainless Steel rivets,
 The heat is distributed evenly over the surface of the pot
 Greater control of cooking temperature
 Considerable saving of energy and time
 Minor alteration of vitamins and proteins during cooking

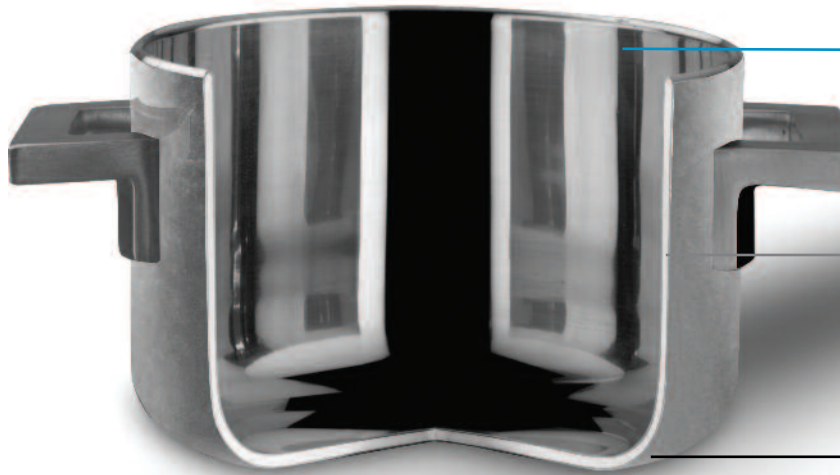

Strato interno - Inner layer

Acciaio Inossidabile 18/10 - Il materiale in assoluto più igienico e più facile da pulire
 Stainless Steel 18/10 - The material even more hygienic easier to clean

Strato centrale - Middle layer

Cuore in alluminio - Il materiale leggero, non soggetto a corrosione ed atossico
 Aluminum core - The lightweight, non-corrosive and non-toxic

Strato esterno - Outer layer

Acciaio speciale per induzione
 Special steel for induction



2831
 Risottiera e tegame per arrosti e brasati in **Trimetallo** con interno in acciaio inossidabile 18/10 senza rivestimento
Tri-ply Low casserole for risotto and stews.

Ø cm. 24 - Lt. 3,0 Ø 9 1/2" - Qt. 3 1/6
 Ø cm. 28 - Lt. 4,0 Ø 11" - Qt. 4 1/5



2821
 Sauteuse per condimenti e salse in **Trimetallo** con interno in acciaio inossidabile 18/10 senza rivestimento
Tri-ply Casserole for serving sauces, soups and side dishes.

Ø cm. 18 - Lt. 2,0 Ø 7" - Qt. 2 1/9
 Ø cm. 20 - Lt. 3,0 Ø 7 7/8" - Qt. 3 1/6
 Ø cm. 22 - Lt. 3,5 Ø 8 2/3" - Qt. 3 2/3
 Ø cm. 24 - Lt. 5,0 Ø 9 1/2" - Qt. 5 1/3



2801
 Pentola in **Trimetallo** con interno in acciaio inossidabile 18/10 senza rivestimento
Tri-ply Deep pot

Ø cm. 20 - Lt. 3,5 Ø 7 7/8" - Qt. 3 2/3
 Ø cm. 22 - Lt. 5,0 Ø 8 2/3" - Qt. 5 1/3
 Ø cm. 24 - Lt. 6,5 Ø 9 1/2" - Qt. 6 1/8



2811
 Mini casseruole per soufflé, condimenti e salse in **Trimetallo** con interno in acciaio inossidabile 18/10 senza rivestimento
Tri-ply Mini casseroles for soufflé, condiments and sauces

Ø cm. 9 - Lt. 0,25 Ø 3 1/2" - Qt. 1/11
 Ø cm. 14 - Lt. 1,0 Ø 5 1/2" - Qt. 1
 Ø cm. 16 - Lt. 2,0 Ø 6 1/3" - Qt. 2 1/9



2821
 Ø cm. 12 - Lt. 0,6
 Ø 4 2/3" - Qt. 1/11



2841
Padella in **Trimetallo**
Tri-ply Frying pan
Poêle à frire
Bratpfanne
Sartén

| | |
|----------|------------------------------------|
| Ø cm. 22 | Ø 8 ² / ₃ " |
| Ø cm. 26 | Ø 10 ¹ / ₄ " |
| Ø cm. 30 | Ø 11 ³ / ₄ " |

Acciaio Inossidabile 18/10, cuore in alluminio, esterno in acciaio per induzione
 Superficie esterna ed interna lucidate a specchio
 Maniglie con rivetti in acciaio inossidabile 18/10, a tenuta rinforzata
 Il calore si distribuisce uniformemente su tutta la superficie della pentola
 Maggiore controllo della temperatura di cottura
 Notevole risparmio di energia e tempo
 Minor alterazione delle vitamine e proteine durante la cottura

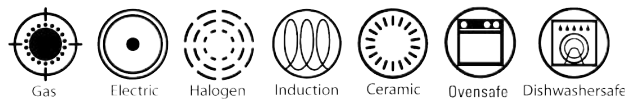

18/10 Stainless Steel, aluminum core, Induction Steel outside
 Mirror polished surfaces, outside and inside
 Handles with strongly fixed 18/10 Stainless Steel rivets,
 The heat is distributed evenly over the surface of the pot
 Greater control of cooking temperature
 Considerable saving of energy and time
 Minor alteration of vitamins and proteins during cooking



Strato interno - Inner layer

Acciaio Inossidabile 18/10 - Il materiale in assoluto più igienico e più facile da pulire
 Stainless Steel 18/10 - The material even more hygienic easier to clean

Strato centrale - Middle layer

Cuore in alluminio - Il materiale leggero, non soggetto a corrosione ed atossico
 Aluminum core - The lightweight, non-corrosive and non-toxic

Strato esterno - Outer layer

Acciaio speciale per induzione
 Special steel for induction



18310

Risottiera e tegame per arrosti e brasati in **Trimetallo** con interno in acciaio inossidabile 18/10 senza rivestimento
Tri-ply Low casserole for risotto and stews.

Ø cm. 24 - Lt. 3,0
 Ø cm. 28 - Lt. 4,0

Ø 9 1/2" - Qt. 3 1/6
 Ø 11" - Qt. 4 1/5



18210

Sauteuse per condimenti e salse in **Trimetallo** con interno in acciaio inossidabile 18/10 senza rivestimento
Tri-ply Casserole for serving sauces, soups and side dishes.

Ø cm. 18 - Lt. 2,0
 Ø cm. 20 - Lt. 3,0
 Ø cm. 22 - Lt. 3,5
 Ø cm. 24 - Lt. 5,0

Ø 7" - Qt. 2 1/9
 Ø 7 1/8" - Qt. 3 1/6
 Ø 8 2/3" - Qt. 3 2/3
 Ø 9 1/2" - Qt. 5 1/3



18010

Pentola in **Trimetallo** con interno in acciaio inossidabile 18/10 senza rivestimento
Tri-ply Deep pot

Ø cm. 20 - Lt. 3,5
 Ø cm. 22 - Lt. 5,0
 Ø cm. 24 - Lt. 6,5

Ø 7 7/8" - Qt. 3 2/3
 Ø 8 2/3" - Qt. 5 1/3
 Ø 9 1/2" - Qt. 6 1/5



18110

Mini casseruole per soufflé, condimenti e salse in **Trimetallo** con interno in acciaio inossidabile 18/10 senza rivestimento
Tri-ply Mini casseroles for soufflé, condiments and sauces

Ø cm. 9 - Lt. 0,25
 Ø 3 1/2" - Qt. 1/11
 Ø cm. 14 - Lt. 1,0
 Ø 5 1/2" - Qt. 1
 Ø cm. 16 - Lt. 2,0
 Ø 6 1/3" - Qt. 2 1/9



18210

Mini casseruole per soufflé, condimenti e salse in **Trimetallo** con interno in acciaio inossidabile 18/10 senza rivestimento
Tri-ply Mini casseroles for soufflé, condiments and sauces

Ø cm. 12 - Lt. 0,6
 Ø 4 2/3" - Qt. 1/11



18410
Padella in **Trimetallo**
Tri-ply Frying pan
Poêle à frire
Bratpfanne
Sartén

| | |
|----------|------------------------------------|
| Ø cm. 22 | Ø 8 ² / ₃ " |
| Ø cm. 26 | Ø 10 ¹ / ₄ " |
| Ø cm. 30 | Ø 11 ³ / ₄ " |





Rame, cuore in alluminio, interno in acciaio inossidabile 18/10 - Superficie esterna ed interna lucidate a specchio - Maniglie con rivetti in acciaio inossidabile 18/10, a tenuta rinforzata

Il calore si distribuisce uniformemente su tutta la superficie della pentola - Maggiore controllo della temperatura di cottura - Notevole risparmio di energia e tempo - Minor alterazione delle vitamine e proteine durante la cottura

Copper, aluminum core, 18/10 Stainless Steel inside - Mirror polished surfaces, outside and inside - Handles with strongly fixed 18/10 Stainless Steel rivets.

The heat is distributed evenly over the surface of the pot - Greater control of cooking temperature - Considerable saving of energy and time - Minor alteration of vitamins and proteins during cooking.

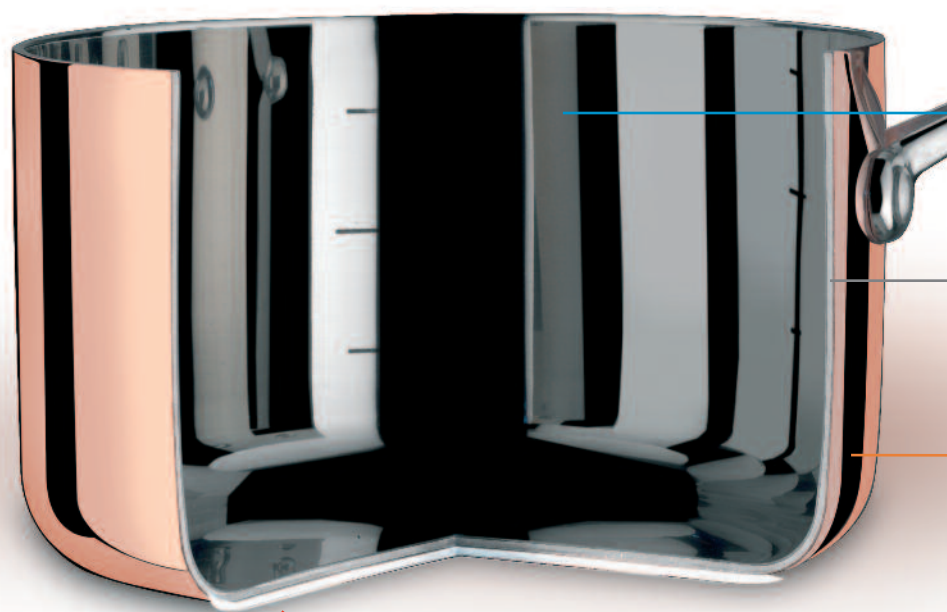
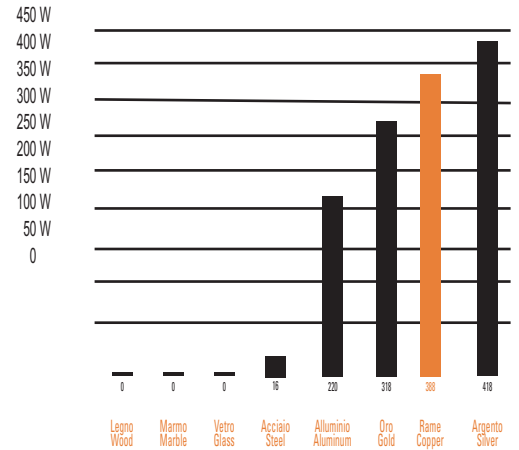

Strato interno - Inner layer

Acciaio Inossidabile 18/10 - Il materiale in assoluto più igienico e più facile da pulire
Stainless Steel 18/10 - The material even more hygienic easier to clean

Strato centrale - Middle layer

Cuore in alluminio - Il materiale leggero, non soggetto a corrosione ed atossico
Aluminum core - The lightweight, non-corrosive and non-toxic

Strato esterno - Outer layer

Rame - Il materiale a più alta conduttività dopo l'argento
Copper - The material with higher conductivity after silver

Fondo speciale - Special bottom

Adatto all'induzione - Suitable for inductions stoves too.

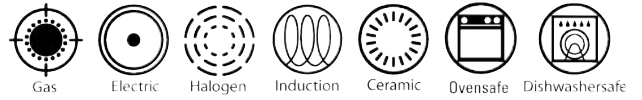

1231

Risottiera e tegame per arrosti e brasati in **Trimetallo** con interno in acciaio inossidabile 18/10 senza rivestimento.
 Low casserole for risotto and stews. **Tri-ply** with 18/10 inside, aluminum and copper.
 Ø cm. 28 - Lt. 4,5 Ø 11" - Qt. 4 1/2



1211

Sauteuse per condimenti e salse in **Trimetallo** con interno in acciaio inossidabile 18/10 senza rivestimento.
Tri-ply saucepan with 18/10 inside, aluminum and copper.
 Ø cm. 16 - Lt. 1,9 Ø 6 1/3" - Qt. 1



1241

Padella in **Trimetallo** con interno in acciaio inossidabile 18/10 senza rivestimento
Tri-ply frying pan with 18/10 inside, aluminum and copper.
 Ø cm. 26 - Lt. 2,9 Ø 10 1/4" - Qt. 2 1/8



1201

Pentola in **Trimetallo** con interno in acciaio inossidabile 18/10 senza rivestimento
Tri-ply deep pot with 18/10 inside, aluminum and copper.
 Ø cm. 20 - Lt. 4,0 Ø 7 7/8" - Qt. 4 1/5
 Ø cm. 24 - Lt. 7,7 Ø 9 1/2" - Qt. 8 1/8



1221

Casseruola per soufflé, condimenti e salse in **Trimetallo** con interno in acciaio inossidabile 18/10 senza rivestimento
Tri-ply Saucepan for soufflé, seasonings and sauces with 18/10 inside, aluminum and copper.
 Ø cm. 20 - Lt. 2,9 Ø 7 7/8" - Qt. 3
 Ø cm. 24 - Lt. 3,5 Ø 9 1/2" - Qt. 3 2/3



2179
Padella antiaderente
Non-stick frying pan
Poêle à frire anti-adhérent
Antihaft Bratpfanne
Sartén antiadherente

| | |
|----------|------------------------------------|
| Ø cm. 20 | Ø 7 ¹ / ₈ " |
| Ø cm. 24 | Ø 9 ¹ / ₂ " |
| Ø cm. 28 | Ø 11" |
| Ø cm. 32 | Ø 12 ⁴ / ₅ " |

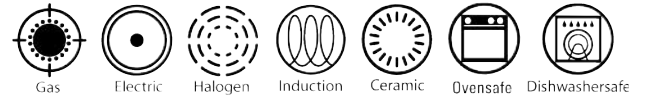

Strato interno - Inner layer

Rivestimento triplo strato antiaderente di ultima generazione, antimacchia. Rivestimento resistente agli utensili metallici non taglienti.

The last generation triple non-stick layer is so strong, that allow you to cook with non-sharp metal utensils.

Strato esterno - Outer layer

Triplo fondo incapsulato per cottura ad induzione

Sandwiched thermoradiant bottom for induction cooking

Acciaio Inossidabile 18/10 - Fondo termodiffusore incapsulato (Acciaio Inossidabile 18/10 - Alluminio - Acciaio per induzione). Bordo antigoccia rinforzato - Lavabile in lavastoviglie senza che ne venga compromessa l'antiaderenza. Le eccezionali proprietà antiaderenti permettono una cucina completamente priva di grassi, per uno stile di vita attivo e salutare. Rispetto della natura e del pianeta, grazie alla totale assenza di PFOA.

18/10 Stainless Steel - Sandwiched thermoradiant bottom (18/10 Stainless Steel - Aluminum - Steel for Induction). Reinforced non-drip edge. The non-stick coating is not compromised during the washing cycle. The outstanding non-stick properties also allow a fully fatfree cuisine, for an active and healthy life. Thanks to the total absence of PFOA, the collection respects the nature.



2180

Bistecchiera ad alto spessore per alte temperature con rivestimento antiaderente, PFOA Free, per induzione, antimacchia, antigraffio.

High gauge steak pan for high heat with "Eterna" non-stick coating, PFOA free, stain resistant and scratch resistant.

cm. 28 x 28 11" x 11"



2131

Risottiera e tegame per arrostiti e brasati con coperchio per alte temperature con rivestimento antiaderente, PFOA Free, per induzione, antimacchia, antigraffio.

Low casserole for risotto and stews with "Eterna" non-stick coating, PFOA free, stain resistant and scratch resistant.

Ø cm. 32 - Lt. 5,0 Ø 12 3/5" - Qt. 5 1/7



2178

Wok saltapasta con coperchio per alte temperature con rivestimento antiaderente, PFOA Free, per induzione, antimacchia, antigraffio.

Wok with lid for high heat with "Eterna" non-stick coating, PFOA Free, for induction, stain resistant and scratch resistant.

Ø cm. 28 - Lt. 3,0 Ø 11 1/4" - Qt. 3 1/2

GOURMET



Gas



Electric



Halogen



Induction



Ceramic



Ovensafe



Dishwashersafe



1501
Pentola alta con coperchio
Deep pot with lid

Ø cm. 20 - Lt. 4,2 Ø 7 7/8" - Qt. 4 2/7
Ø cm. 22 - Lt. 4,8 Ø 8 2/3" - Qt. 5
Ø cm. 24 - Lt. 5,4 Ø 9 1/2" - Qt. 5 2/3



1511
Casseruola 1 manico con coperchio
Deep casserole 1 handle with lid

Ø cm. 16 - Lt. 1,5 Ø 6 1/3" - Qt. 1 2/5



1521
Casseruola fonda 2 manici con coperchio
Deep casserole 2 handles with lid

Ø cm. 20 - Lt. 2,9 Ø 7 7/8" - Qt. 3
Ø cm. 22 - Lt. 3,3 Ø 8 2/3" - Qt. 3 1/2
Ø cm. 24 - Lt. 3,8 Ø 9 1/2" - Qt. 4



1531
Tegame 2 manici con coperchio
Frying pan 2 handles with lid

Ø cm. 26 - Lt. 3,3 Ø 10 1/4" - Qt. 3 1/2
Ø cm. 30 - Lt. 5,6 Ø 11 4/5" - Qt. 5 7/8



1500/08

Batteria da cucina 8 pezzi
8 pcs. Kitchen set
Composta da - Composed by:

| | | |
|----------------------------|----------|-----------|
| 1 Pentola alta - Deep pot | Ø cm. 20 | Ø 7 7/8" |
| 1 Casseruola 1 manico | Ø cm. 16 | Ø 6 1/3" |
| 1 Deep casserole 1 handle | | |
| 1 Casseruola 2 manici | Ø cm. 20 | Ø 7 7/8" |
| 1 Deep casserole 2 handles | | |
| 1 Tegame 2 manici | Ø cm. 26 | Ø 10 1/4" |
| 1 Frying pan 2 handles | | |
| 2 Coperchi - Lids | Ø cm. 20 | Ø 7 7/8" |
| 1 Coperchio - Lid | Ø cm. 16 | Ø 6 1/3" |
| 1 Coperchio - Lid | Ø cm. 26 | Ø 10 1/4" |



1500/14

Batteria da cucina 14 pezzi
14 pcs. Kitchen set
Composta da - Composed by:

| | | |
|----------------------------|----------|-----------|
| 1 Pentola alta - Deep pot | Ø cm. 20 | Ø 7 7/8" |
| 1 Casseruola 1 manico | Ø cm. 16 | Ø 6 1/3" |
| 1 Deep casserole 1 handle | | |
| 1 Casseruola 2 manici | Ø cm. 20 | Ø 7 7/8" |
| 1 Deep casserole 2 handles | | |
| 1 Tegame 2 manici | Ø cm. 26 | Ø 10 1/4" |
| 1 Frying pan 2 handles | | |
| 1 Spghettiera | Ø cm. 22 | Ø 8 2/3" |
| 1 Pasta pot (3pcs) | | |
| 1 Cuociverdura | Ø cm. 22 | Ø 8 2/3" |
| 1 Vegetable steamer (3pcs) | | |
| 1 Coperchio - Lid | Ø cm. 16 | Ø 6 1/3" |
| 2 Coperchi - Lids | Ø cm. 20 | Ø 7 7/8" |
| 1 Coperchio - Lid | Ø cm. 26 | Ø 10 1/4" |





1579
Padella antiaderente
Non-stick frying pan
Poêle à frirre anti-adhérent
Antihaft Bratpfanne
Sartén antiadherente
Ø cm. 22 Ø 8 ¹/₃"
Ø cm. 26 Ø 10 ¹/₄"
Ø cm. 30 Ø 11 ¹/₅"



GOURMET

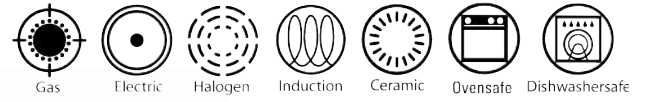

1578
Wok antiaderente con coperchio
Non-stick wok with lid

Ø cm. 30 - Lt. 5,0 Ø 11 3/4" - Qt. 5 1/4



1581
Bollilatte
Milk boiler

cm. 12 - Lt. 1,2

Ø 4 3/4" - Qt. 1 1/2



1591
Inserto cuocipasta 2 scomparti
Pasta pot insert 2 compt.

Per pentola Ø cm. 24
For pot Ø 9 1/2"



883
Colapasta
Colander

cm. 33 13"



1571
Cuocipasta con coperchio
Pasta pot with lid

Ø cm. 22 - Lt. 6,6

Ø 8 2/3" - Qt. 7



1572
Cuociverdura con coperchio
Vegetable steamer with lid

Ø cm. 22 - Lt. 4,3

Ø 8 2/3" - Qt. 4 1/2

Spa & Wellness



- Infrangibile
- Adatto alla lavastoviglie
- Adatto al forno a microonde
- Ideale per:
 - Discoteche
 - Yacht e navi da crociera
 - Cliniche
 - Case di riposo per anziani
 - Asili
- Ideale per tutti i luoghi dove i clienti possono accedere a piedi nudi:
 - Piscine
 - Spiagge
 - Prati
 - Centri di benessere
 - Impianti sportivi
 - Tonalità diverse disponibili a richiesta
- Possono essere personalizzati con logo, anche a più colori

- Unbreakable
- Dishwasher Safe
- Microwave Safe
- Ideal for:
 - Night Clubs
 - Yachts and Cruise Ships
 - Hospitals and Medical Clinics
 - Rest Homes
 - Schools
 - Perfect for Barefoot Environments:
 - Swimming Pools
 - Beaches
 - Lawns
 - Wellness Centers
 - Fitness Centers
 - Available in additional colors.
- Imprinting and logos available. Multicolor printing available.

- Incassable
- Utilisable au laves-vaisselles
- Utilisable au Four à micro-ondes
- Idéal pour :
 - Discothèques
 - Yacht et bateaux de croisière
 - Cliniques
 - Maisons de repos
 - Crèches
- Idéal pour tous les lieux où les clients peuvent accéder à pied nus :
 - Piscines
 - Plages
 - Jardin
 - Centre de bien-être

- Installations sportives
- Tonalités différentes disponibles sur demande
Ils peuvent être personnalisés avec logo, multicouleurs, gravées ou lazer

- Unzerbrechlich
- Spülmaschinenfest
- Microwellenfest
- Daher bestens geeignet zum Gebrauch:
- in Cocktailbars & Night Clubs
- für Yachten und Kreuzfahrtschiffe
- in Kliniken und Heimen
- in Badezimmern
- für Schulen und Kindergärten

Auch aufgrund der Bruchsicherheit perfekt einzusetzen an Orten, die barfuß betreten werden:

- Schwimmbäder und Poolbereiche
- Strände und Strandbars
- Rasenflächen
- Wellnesscenter
- Fitnesscenter
- Alle Produkte sind auch in zusätzlichen, weiteren Farben erhältlich.
- Alle Produkte können auch mit Logos und Beschriftung individualisiert werden.
- Dabei ist auch mehrfarbiger Druck möglich.

- Irrompible
- Apto para lavavajillas
- Apto para microondas
- Ideal para:
- Discotecas
- Yates y barcos de crucero
- Clinicas
- Residencias de ancianos
- Asilos
- Ideal para todos los lugares donde los clientes pueden ir descalzos:
- Piscinas
- Playas
- Praderas
- Centros de bienestar
- Centros deportivos
- Tonos diversos disponibles por encargo
- Se pueden personalizar con logo, incluso en varios colores.



588



Bicchiere
Glass
Gobelet
Glas
Vaso

H cm 10
cl. 33
H 3⁷/₈"
oz. 11 ¹/₈

591



Bicchiere
Glass
Gobelet
Glas
Vaso

H cm 13
cl. 45
H 5"
oz 15 ¹/₄

554



Fondo
Bowl
Bol
Obstschale oval
Cuenco

Ø cm. 18 Ø 7"

553

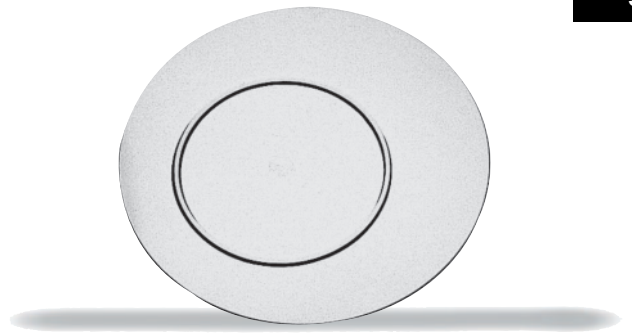

Piano
Tray
Plateau
Tablett oval
Bandeja

Ø cm. 27 Ø 10 ¹/₂"

555



Piano per buffet
Tray for buffet
Plateau pour buffet
Buffettablett
Bandeja para buffet

Ø cm. 27 Ø 10 ¹/₂"

536



Coppa per gelato
Ice cream cup
Coupe à glace
Eisbecher
Copa helado

H cm 12 H 4 3/4"
cl. 27 oz 9 1/8

535



Coppa Martini
Martini glass
Coupe à Martini
Martini glas
Vaso para Martini

H cm. 19 H 7 1/2"
cl 27 oz 9 1/8

534



Bicchiere per birra
Beer glass
Gobelet pour birre
Bierbecher
Vaso para cerveza

H cm. 17,5 H 6 7/8"
cl 45 oz 15 1/8

533



Bicchiere per vino
Beverage glass
Gobelet pour vin
Weinbecher
Vaso para vino

H cm. 24,5 H 9 1/3"
cl 45 oz 15 1/8

527



Bicchiere da whisky
Whisky glass
Gobelet pour whisky
Whisky Becher
Vaso para whisky

cl. 15
oz. 5 1/8

531



Bicchiere da liqueure
Liquor glass
Gobelet pour alcool
Schnapsbecher
Vaso para alcohol

cl. 9
oz. 3

543



Bicchiere per champagne
Champagne glass
Gobelet pour champagne
Champagnerglas
Vaso para champany

H cm. 22,7 H 9"
cl. 15 oz. 5 1/8

589



Ciotola tonda
Round bowl
Bol ronde
Früchtekorb, rund
Cuenco redondo

Ø cm. 12 Ø 4 3/4"
H cm. 7,4 H 2 7/8"
cl. 40 oz. 13 1/2

605



Set impilabile di 3 coppette tonde
Stackable set of 3 round bowls
Set empilable de 3 bols ronde
Stapelbarer Relish-Pickles-Gestell , rund
Set impilable de 3 cuencos redondos

cl. 40 (x 3) oz. 13 1/2 (x 3)

589



Ciotola tonda
Round bowl
Bol ronde
Früchtekorb rund
Cuenco redondo

Ø cm. 22 Ø 8 1/2"
H cm. 14 H 5 1/2"
cl. 220 oz. 74 3/8

589+599



Ciotola tonda
Round bowl
Bol ronde
Früchtekorb rund
Cuenco redondo

Ø cm. 28 Ø 11"
H cm. 17,3 H 6 5/8"
lt. 6,03 oz. 202 1/2

589



550



Mug

H cm 10
cl. 33 H 3 7/8"
oz. 11 1/8

552



Piattino per mug e bicchieri (Art. 550,588,591) Ø cm. 13,2 Ø 5 1/4"
Mug coaster (Art. 550,588,591)
Dessous de verre (Art. 550,588,591)
Gläseruntersatz (Art. 550,588,591)
Posavasos por mug (Art. 550,588,591)

592



Tazzina da caffè con piattino
Express coffee cup and saucer
Tasse de moka avec soucoupe
Mokka Tasse mit Untertasse
Taza de moka con platillo

cl 9 oz. 3

593



Tazza da tè con piattino
Tea cup and saucer
Tasse de thé avec soucoupe
Tee Tasse mit Untertasse
Taza de tè con platillo

cl 15 oz 5 1/8

590



Ciotola quadra
Square bowl
Bol carrè
Obstschale viereckig
Cuenco cuadrado

cm. 10 x 10 3 7/8" x 3 7/8"
cl. 27 oz. 9 1/8

606



Set impilabile di 3 coppette quadre
Stackable set of 3 square bowls
Set empilable de 3 bols carrè
Stapelbarer Relish-Pickles-Gestell,
quadratisch
Set impilable de 3 cuencos cuadrados

cl. 27 (x 3) oz. 9 1/8 (x 3)



A Ambra
Amber
Ambre
Amber
Ambar



G Granato
Garnet
Grenat
Granat
Granate



Q Quarzo
Quartz
Quartz
Quarz
Cuarzo



S Smeraldo
Emerald
Emeraude
Smaragd
Esmeralda



V Olivina
Olivine
Olivine
Olivia
Olivino



Z Zaffiro
Sapphyre
Saphir
Saphir
Zafiro

Tutti gli articoli da pagina 342 a pagina 345 sono disponibili in 8 colori, tranne il nero. Gli articoli 533, 534, 535, 536 e 543 sono disponibili solo in 3 colori: bianco, nero e trasparente.

All the items from page 342 to page 345 are available in 8 colors, black excluded. The items 533, 534, 535, 536 and 543 are available in 3 colors only: white, black and transparent.

Tous les articles de la page 342 à la page 345 sont disponibles en 8 couleurs, noir exclu. Les articles 533, 534, 535, 536 et 543 sont uniquement disponibles en 3 couleurs: porcelain, noir et transparent.



M Ametista
Amethyst
Amethyste
Amethyst
Amatista

Alle Polikarbonat-Produkte von Seite 342 bis Seite 345 sind in 8 Farben erhältlich, außer Schwarz. Die Artikel 533, 534, 535, 536 und 543 sind nur in 3 Farben erhältlich: Weiß, Schwarz und Transparent.

Todos los artículos desde la página 342 hasta la página 345 están disponibles en 8 colores, excepto el negro. Los artículos 533, 534, 535, 536 y 543 solo están disponibles en 3 colores: porcelana, negro y transparente.



W Trasparente
Transparent
Glace
Transparent
Vidrio



B Berillo
Beryl
Beryl
Beryl
Berilo



O Onice
Onyx
Onyx
Onyx
Onice



P Porcellana
White
Porcelain
Weiss
Porcelana



N Nero
Black
Noir
Schwarz
Negro



R Rosso
Red
Rouge
Rot
Rojo



886



Secchiello per ghiaccio
Ice bucket
Seau à glaçons
Eisgefäß
Cubitera hielo

Ø cm. 15 Ø 5 7/8"
H cm. 15 H 5 7/8"
cl. 150 oz. 50 3/4

888



Secchiello per spumante
Sparkling wine cooler
Seau à vin/glace
Wein- und Sektkühler
Cubo para champany

Ø cm. 22 Ø 8 7/8"
H cm. 22 H 8 7/8"
lt. 5 gal. 1 1/4

891



Bicchiere
Glass
Gobelet
Glas
Vaso

H cm. 13 H 5"
cl. 33 11 1/8 oz

892



Bicchiere
Glass
Gobelet
Glas
Vaso

H cm. 10 H 4"
cl. 25 8 2/5 oz

517

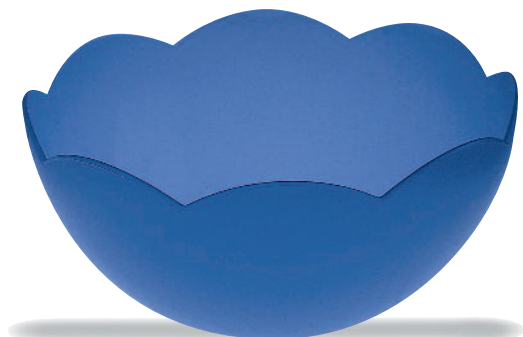

Ciotola
Bowl
Bol
Obstschale
Cuenco

Ø cm. 10 Ø 3 7/8"
cl. 30 oz. 10 1/8
Ø cm. 15 Ø 5 7/8"
cl. 60 oz. 20 1/4
Ø cm. 22 Ø 8 7/8"
cl. 200 oz. 67 7/8
Ø cm. 28 Ø 11"
lt 4 gal. 1

099

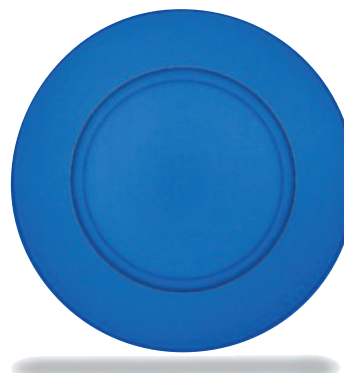

Sottopiatto
Charger
Assiette de bienvenue
Platzteller
Bajo plato

CARAMELLA Ø cm. 32 Ø 12 7/8"
" "
" "
" "

892



W Ghiaccio
Ice
Glace
Eis
Hielo



O Arancio
Orange
Orange
Orange
Naranja



G Limone
Lemon
Jaune
Zitrone
Amarillo



E Verde acido
Acid green
Vert acide
Azid Grün
Pistacho



B Anice
Anis
Bleu
Blau
Azul



U Luce di Wood
Wood light
Lumière de Wood
Schwarzlicht
Luz de Wood
Solo art. 891 - 892
Only for art. 891 - 892
Seulement pour art. 891 - 892
Nur für Art. 891 - 892
Solo para art. 891 - 892

Tutti gli articoli di pagina 348 sono disponibili in 5 colori

All the items of page 348 are available in 5 colors

Toutes les articles de page 348 sont disponibles en 5 couleurs

Alle Produkte von Seite 348 sind in 5 Farben bzw. Ausführungen erhältlich

Todos los artículos de pagina 348 son disponibles en 5 colores

Trolleys



- Carrelli multifunzionali
Vasta gamma di accessori disponibili
- Molteplici finiture
- Ruote speciali a grandezza maggiorata, fascia in gomma antistatica e antitraccia
- Angolari rinforzati
- Logo a richiesta

- Multifunctional trolleys
A complete range of optional accessories
- Numerous customization choices
- The oversized wheels are anti-static, won't leave marks.
- Reinforced legs
- Company logo on demand

- Chariots multifonctions
Complète dotation d'accessoires disponibles
- Variété de finitions
- Roulettes surdimensionnées spéciales, avec bande en caoutchouc synthétique conducteur antitrace
- Arêtes renforcées
- Logo à la demande

- Multifunktioneller Trolley
Grosse Auswahl von optionalem Zubehör
- Grosse Auswahl von Oberflächen- Variationen und Lack-Farben
- Besonders grossdimensionierte Rollen mit antistatischen Gummireifen, die keinen Abrieb hinterlassen
- Spezialverstärkte Beine
- Ihr Firmen-Logo auf Wunsch als Option

- Carros multifunción
Vasta gama de accesorios opcionales
- Múltiples acabados
- Ruedas especiales de mayor tamaño, con cinta de goma antistática y antihuellas
- Angulares reforzados
- Logo a solicitud

MEPRÁ
S.p.A.

TROLLEYS

LONDON



Gueridon

H cm 80
cm 80 x 40

H 31 1/2"
31 1/2" x 15 3/4"

DELUXE

031



032



Massello con angolari in acciaio inossidabile 18/10
Solid wood with 18/10 Stainless Steel legs
Massif avec arêtes en inox 18/10
Massivholz, Beine mit Edelstahl Rostfrei 18/10 Profi-
len verblendet
Tablero con angulares en acero inox 18/10

VIP

036



037



Massello con angolari in massello
Trolley and solid wood legs
Panneaux massif
Trolley und Beine komplett aus Massivholz
Tablero macizo con angulares macizos

COLORI

| | | | | |
|--|--|--|------------|--|
| | | 031 036 | 032 037 | |
| | | Noce Walnut Noyer Walnuss Nuez | Wengè | |

TROLLEYS

HAVANA



H cm 87
cm 50 x 50

H 34 ¹/₄"
19 ³/₄" x 19 ³/₄"

DELUXE

121



122



Massello con angolari in acciaio inossidabile 18/10
Solid wood with 18/10 Stainless Steel legs
Massif avec angle en inox 18/10
Massivholz, Beine mit Edelstahl Rostfrei 18/10
Profilen verblendet
Tablero con angulares en acero inox 18/10

VIP

126



127



Massello con angolari in massello
Trolley and solid wood legs
Panneaux massif avec angles et hanches massif
Trolley und Beine komplett aus Massivholz
Tablero macizo con angulares macizos

COLORI

| | | | | |
|--|--|--|------------|--|
| | | 121 126 | 122 127 | |
| | | Noce Walnut Noyer Walnuss Nuez | Wengè | |

TROLLEYS

NIZZA



H cm 87 H 34 1/4"
cm 50 x 50 19 3/4" x 19 3/4"

DELUXE

091



092

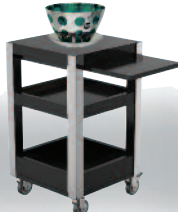

Massello con angolari e maniglioni in acciaio inossidabile 18/10
Solid wood with 18/10 Stainless Steel handles and legs
Massif avec arêtes et hanches en inox 18/10
Massivholz, Beine mit Edelstahl Rostfrei 18/10 Profilen
verblendet, Griffe 18/10
Tablero con angulares y asas en acero inox 18/10

Questo carrello comprende un inserto avvitato sul piano ed il relativo secchiello per champagne, art. 599 + art. 589 (colore a vostra scelta).

This trolley includes a screwed insert onto the top and the relative champagne cooler, art. 599 + art. 589 (color to your choice).

Ce chariot comprend un supplément vissé sur l'étagère et le relatif seau à champagne, art. 599 + art. 589 (couleur à votre choix).

Dieser Trolley einschl. fixiertem Halter für Weinkühler, art. 599 einschl. Weinkühler mit Einsatz, art. 589 (Farben zu Ihrer Wunsch).

Esto carro comprende un legajo atornillado sobre el plan y el relativo cubo por champán, art. 599 + art. 589 (color a vuestra elección).

COLORI

| | | 091 | 092 | |
|--|--|--|-------|--|
| | | Noce Walnut Noyer Walnuss Nuez | Wengè | |

TROLLEYS

LAS VEGAS



H cm 83 H 32 3/4"
cm 104 x 57 41" x 22 1/2"

DELUXE

051



052



Massello con angolari e maniglioni in acciaio inossidabile 18/10
Solid wood with 18/10 Stainless Steel handles and legs
Massif avec arêtes et hanches en inox 18/10
Massivholz, Beine mit Edelstahl Rostfrei 18/10 Profilen
verblendet, Griffe 18/10
Tablero con angulares y asas en acero inox 18/10

VIP

056



057



Massello con angolari e maniglioni in massello
Trolley and solid wood handles and legs
Panneaux massif avec angles et hanches massif
Trolley und Beine komplett aus Massivholz
Tablero macizo con angulares y asas macizas

COLORI

| | | | | |
|--|--|--|------------|--|
| | | 051 056 | 052 057 | |
| | | Noce Walnut Noyer Walnuss Nuez | Wengè | |

TROLLEYS

DALLAS



H cm 83 H 32 3/4"
cm 104 x 57 41" x 22 1/2"

DELUXE

041



042



Massello con angolari e maniglioni in acciaio inossidabile 18/10
Solid wood with 18/10 Stainless Steel handles and legs
Massif avec arêtes et hanches en inox 18/10
Massivholz, Beine mit Edelstahl Rostfrei 18/10 Profilen
verblendet, Griffe 18/10
Tablero con angulares y asas en acero inox 18/10

VIP

046



047



Massello con angolari e maniglioni in massello
Trolley and solid wood handles and legs
Panneaux massif avec angles et hanches massif
Trolley und Beine komplett aus Massivholz
Tablero macizo con angulares y asas macizas

COLORI

| | | | | |
|--|--|--|------------|--|
| | | 041 046 | 042 047 | |
| | | Noce Walnut Noyer Walnuss Nuez | Wengè | |

TROLLEYS

MIAMI



H cm 82
cm 80 x 91

H 32 1/4"
31 1/2" x 35 7/8"

DELUXE

106

107



Massello con angolari in acciaio inossidabile 18/10
Solid wood with 18/10 Stainless Steel legs
Massif avec angle en inox 18/10
Massivholz, Beine mit Edelstahl Rostfrei 18/10
Profilen verblendet
Tablero con angulares en acero inox 18/10

VIP

101

102



Massello con angolari in massello
Trolley and solid wood legs
Panneaux massif avec angles et hanches massif
Trolley und Beine komplett aus Massivholz
Tablero macizo con angulares macizos

COLORI

| | | | | |
|--|--|--|------------|--|
| | | 101 106 | 102 107 | |
| | | Noce Walnut Noyer Walnuss Nuez | Wengè | |

TROLLEYS



MANIGLIA

Maniglione a scomparsa, regolabile in altezza, per la corretta postura della schiena durante la movimentazione.

HANDLE

The foldaway handle can be ergonomically adjusted to the height of the user during transport.

POIGNÉE

Poignée disparible, réglable en hauteur, pour la posture correcte du dos pendant le mouvements.

SCHIEBEGRIFF

Der einklappbare Schiebegriff kann ergonomisch exakt auf die passende Höhe des Fahrers eingestellt werden, die er zum jeweiligen Transport benötigt.

AGARRADOR

Agarrador abatible, ajustable en altura, para una correcta postura de la espalda durante el uso.



HOT BOX

Contenitore Hot Box elettrico a 4 scomparti, con termostato regolabile fino a 90° C. Diametro massimo dei piatti inseribili: 31 cm.

HOT BOX

Electric Hot Box compartment, 4 compartments with adjustable thermostat up to 194° F. Maximum inner dimension:: 12 1/4".

HOT BOX

Récipient Hot Box électrique aux 4 compartiments, avec thermostat réglable jusqu'à 90° C. Maximum diamètre des plats insertables: 31 cms.

HOT BOX

Elektrisch betriebene HOT BOX mit 4 Abteilungen, mit jeweils Nutzfläche bis zu 31 cm Durchmesser. Die HOT BOX ist ausgestattet mit einem regelbaren Thermostat bis zu 90° C.

HOT BOX

Contenedor eléctrico de 4 compartimentos, con termostato ajustable a 90° C. Diámetro máximo de los platos insertables: 31 cm.



PIANO SUPERIORE ESTENSIBILE

Piano superiore estensibile "a tavolino", massima estensione cm. 92 x 80

EXTENDABLE UPPER SURFACE

Upper surface can be extended up to 36 1/4" x 31 1/2"

PLAT SUPÉRIEUR EXTENSIBLE

Plat supérieur extensible, meilleure étendue cm. 92 x 80.

AUSKLAPPBARE TISCHFLÄCHE

Die Tischfläche kann durch Ausklappen vergrößert werden auf das Mass von 92 x 80 cm.

PLANO SUPERIOR EXTENSIBLE

Plano superior extensible, medida total extendida 92 x 80 cm.

TROLLEYS



SCOMPARTI
Scomparti portabottiglie e bicchieri.

COMPARTMENTS
Compartments for wine bottles, glasses and stemware are also available.

COMPARTIMENTS
Compartiments portebouteilles et verres.

FÄCHER
Fächer für Weinflaschen, Becher und Stielgläser sind ebenfalls erhältlich.

COMPARTIMENTOS
Compartimentos para botellas y vasos.



CARATTERISTICHE
Alta resistenza, massima maneggevolezza, ruote maggiorate ed antistatiche.

FEATURES
Durable oversized casters feature maximum maneuverability with non-tracking and non-conductive rubber wheels.

CARACTÉRISTIQUES
Haute résistance, meilleure maniabilité, roues augmentées et antistatiques.

BESONDERHEITEN
Die groß-dimensionierten, robusten Rollen aus antistatischem Gummi-Material erlauben eine hochgrade Beweglichkeit, selbst bei der Überwindung schwierigster Hindernisse und unterschiedlichsten Bödenbelägen.

CARACTERÍSTICAS
Alta resistencia, máxima manejabilidad, ruedas grandes y antiestáticas.

HOT BOX
Contenitore Hot Box elettrico a 4 scomparti, con termostato regolabile fino a 90° C. Diametro massimo dei piatti inseribili: 31 cm.

HOT BOX
Electric Hot Box compartment, 4 compartments with adjustable thermostat up to 194° F. Maximum inner dimension:: 12 1/4".

HOT BOX
Récipient Hot Box électrique aux 4 compartiments, avec thermostat réglable jusqu'à 90° C. Maximum diamètre des plats insertables: 31 cms.

HOT BOX
Elektrisch betriebene HOT BOX mit 4 Abteilungen, mit jeweils Nutzfläche bis zu 31 cm Durchmesser. Die HOT BOX ist ausgestattet mit einem regelbaren Thermostat bis zu 90° C.

HOT BOX
Contenedor eléctrico de 4 compartimentos, con termostato ajustable a 90° C. Diámetro máximo de los platos insertables: 31 cm.

110



DELUXE - VIP



H cm 5,5

H 2 1/4"

Tutte le versioni Deluxe e Vip hanno la struttura in massello e il piano superiore in massello listellare. Colori optional: faggio, ciliegio, rovere e mogano.

All the wood components for the Deluxe and Vip versions are made from solid wood and the workspace top is made from heavy duty solid Block Wood Available colors: Beachwood, Cherry, Oak and Mahogany

Toutes les versions Deluxe et Vip ont la structure en massif et le plan supérieur en massif. Couleurs facultatif: Hêtre, Cerise, Chêne et Acajou.

Alle Ausführungen für die Deluxe- und VIP-Versionen sind hergestellt aus massivem Holz und die oberen Arbeitsbereiche aus strapazierfähigem, solidem Blockholz
Verfügbare Farben: Buche, Kirsche, Eiche und Mahagoni

Todas las versiones "Deluxe" y "Vip" tienen la estructura en tablero macizo y el plano superior en tablero macizo listelar
Colores disponibles: Haya, Cerezo, Roble y Caoba

RICAMBI



cm 15,5 x 7,5
H cm 2

6" x 2 7/8"
H 1"

Piastre eutettiche senza evaporatore, disponibili per tutte le cupole: congelate a -21°C, durano fino a tre ore.

Eutectic cooling plates without evaporator are available for all of the roll-top covers. Refrigerated to -5,8°F, they will keep cool for approximately 3 hours.

Bacs eutectiques sans évaporateur, sont disponibles pour toutes les lavallières: réfrigérée à -21° C, ils durent jusqu'à trois heures.

Eutektische Kühlplatten ohne Verdampfer, für alle Roll-top Aufsatz erhältlich: vor dem Gebrauch, im Gefrierschrank mit -21°C abkühlen; damit verfügen Sie über 3 Stunden Kühlleistung.

Planchas eutecticas sin vaporizador, disponibles para todas las cúpulas: congeláis a -21°C, duran hasta tres horas.

800



H cm 29
cm 11 x 11

H 11 3/8"
4 1/2" x 4 1/2"

Campionario colore per sala esposizione
Colori disponibili: noce, wengè, bianco, nero e oro.

Color Displayer for show room
Available colors: walnut, wenge, gold, black and white.

Couleur Displayer pour show room
Couleurs disponibles: Noyer, Wenge, Blanc, Noir et Or.

Farben Displayer für Show-Room
Erhältliche Farben: Walnuss, Wenge, Weiss, Schwarz und Gold.

Color Displayer para sala de exposiciones
Colores disponibles: Nogal, Wenge, Blanco, Negro y Oro.

ACCESSORI

219

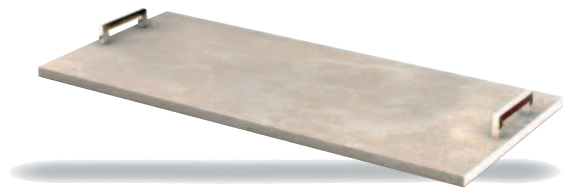

cm 83 x 36
H cm 2

32 3/4" x 14 1/4"
H 1"

Piano in marmo granito, perfettamente levigato e lucidato.

Perfectly ground and polished granite marble top surface.

Plan en marbre granulé, parfaitement lissé et poli.

Polierte Granit-Marmor-Platte mit perfekt glatt geschliffener Oberfläche.

Plano en mármol granito, perfectamente pulido.

TROLLEYS

PARIS

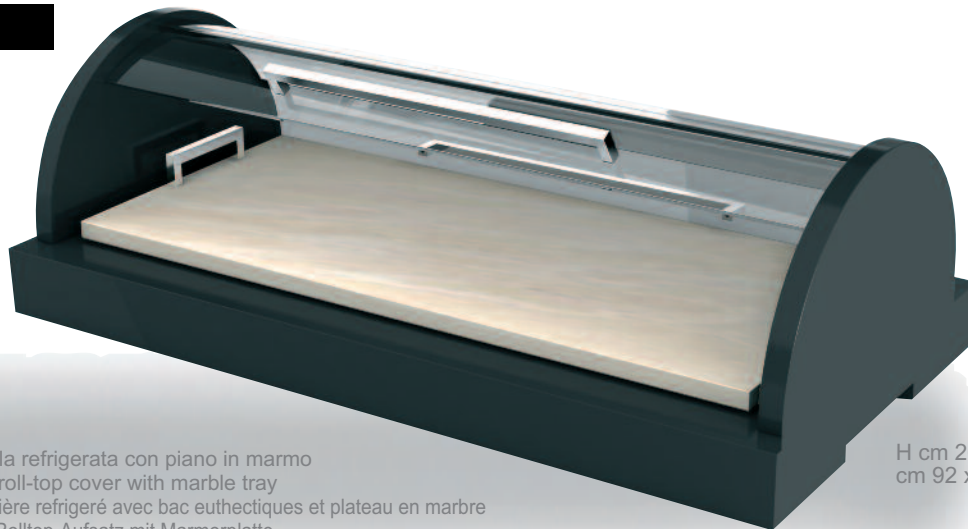

Cupola refrigerata con piano in marmo
Cool roll-top cover with marble tray
Lavallière réfrigéré avec bac eutectiques et plateau en marbre
Kühl-Rolltop-Aufsatz mit Marmorplatte
Cúpula refrigerada con plano en mármol

H cm 26,5
cm 92 x 47

H 10 1/2"
36 1/2" x 18 1/2"

DELUXE

161

162

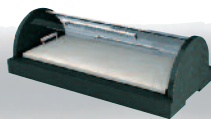
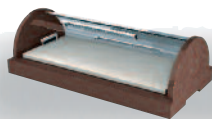

Massello
Solid wood
Massif
Massivholz
Tablero macizo

225

COLORI



- 2 Piastre eutettiche senza evaporatore sono già inserite nella cupola refrigerata
- 2 Eutectic cooling plates without evaporator are already inserted into the roll-top cover
- 2 Bacs eutectiques sans évaporateur sont déjà insérés dans la lavallière
- 2 Bereits eingelegte Kühlaccus gehören mit zum Lieferumfang
- 2 Planchas eutecticas sin vaporizador son ya insertadas en la cúpula refrigerada

| | | | | |
|--|--|--|-------|--|
| | | 161 | 162 | |
| | | Noce Walnut Noyer Walnuss Nuez | Wengè | |

WIEN

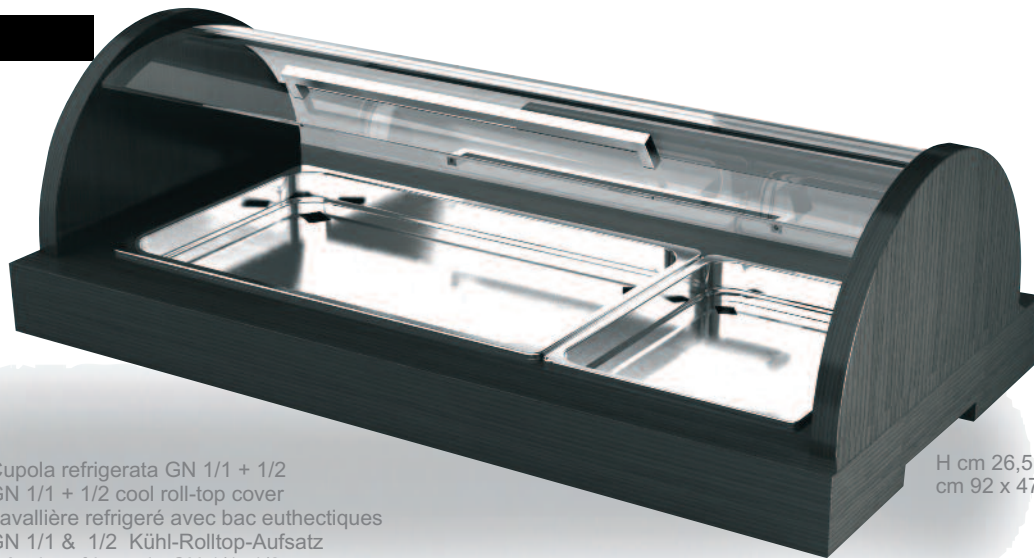

Cupola refrigerata GN 1/1 + 1/2
 GN 1/1 + 1/2 cool roll-top cover
 Lavallière réfrigéré avec bac eutectiques
 GN 1/1 & 1/2 Kühl-Rolltop-Aufsatz
 Cúpula refrigerada GN 1/1 -1/2

H cm 26,5
 cm 92 x 47

H 10 1/2"
 36 1/4" x 18 1/2"

DELUXE

141

142



Massello
 Solid wood
 Massif
 Massivholz
 Tablero macizo

225

COLORI



- 2 Piastre eutettiche senza evaporatore sono già inserite nella cupola refrigerata
- 2 Eutectic cooling plates without evaporator are already inserted into the roll-top cover
- 2 Bacs eutectiques sans évaporateur sont déjà insérés dans la lavallière
- 2 Bereits eingelegte Kühlaccus gehören mit zum Lieferumfang
- 2 Planchas eutecticas sin vaporizador son ya insertadas en la cúpula refrigerada

| | | | | |
|--|--|--|-------|--|
| | | 141 | 142 | |
| | | Noce Walnut Noyer Walnuss Nuez | Wengè | |

TROLLEYS

TEVERE



H cm 80 H 31 1/2"
cm 80 x 40 31 1/2" x 15 3/4"

302



Pannello nobilitato in essenza
Laminated panel
Panneaux noble
Lackierte Paneele
Tablero lacado

309



Pannello nobilitato in essenza
Laminated panel
Panneaux noble
Lackierte Paneele
Tablero lacado

COLORI

| 302 | | 309 |
|-------|--|---|
| Wengè | | Castagno chiaro Light chestnut Châtain clair Heile Kastanie Castaño claro |

TROLLEYS

MISSISSIPPI



H cm 85
cm 98 x 57

H 33 1/2"
38 3/8" x 22 3/8"

332



Pannello nobilitato in essenza
Laminated panel
Panneaux noble
Lackierte Paneele
Tablero lacado

339



Pannello nobilitato in essenza
Laminated panel
Panneaux noble
Lackierte Paneele
Tablero lacado

COLORI

| 332 | | 339 |
|-------|--|---|
| Wengè | | Castagno chiaro Light chestnut Châtain clair Heile Kastanie Castaño claro |

TROLLEYS

RENO



H cm 85 H 33 1/2"
cm 50 x 50 19 3/4" x 19 3/4"

322



Pannello nobilitato in essenza
Laminated panel
Panneaux noble
Lackierte Paneele
Tablero lacado

329



Pannello nobilitato in essenza
Laminated panel
Panneaux noble
Lackierte Paneele
Tablero lacado

COLORI

| 322 | | 329 |
|-------|--|---|
| Wengè | | Castagno chiaro Light chestnut Châtain clair Heile Kastanie Castaño claro |

Alta resistenza al graffio per il normale utilizzo

High resistance to scratch for normal use
 Hautes résistance aux griffures
 Kratzfest bei normalem Gebrauch.
 Alta resistencia a las rayas resultantes del uso normal

**Idrorepellente non cambia colore a contatto con liquidi e cibi**

Hydro repellent, it doesn't change colour when in contact with liquids or foods.
 Matière ne subissant aucunes agressions exterieurs, liquide et autres.....
 Wasserfest, keine Farbveränderung bei Kontakt mit Flüssigkeiten oder Esswaren.
 Repelente al agua, no cambia de color al entrar en contacto con líquidos y alimentos.

**Ruote speciali a grandezza maggiorata, fascia in gomma antistatica e antitraccia.
Ruote e struttura potenziate ad alta portata**

The oversized wheels are antistatic, won't leave marks.
 Wheels and enhanced high-range structure.
 Roulettes surdimensionnées spéciales, avec bande en caoutchouc synthétique conducteur antitrace.
 Roues et roulements adaptées en fonction du poids de la table roulante.
 Besonders grossdimensionierte Rollen mit antistatischen Gummireifen, die keinen Abrieb hinterlassen.
 Die Rollen und das Gefüge verstärkte sind, um grössere Fähigkeit zu tragen.
 Ruedas especiales de mayor tamaño, con cinta de goma antistatica y antihuellas.
 Ruedas y estructura mejoradas de alta capacidad.

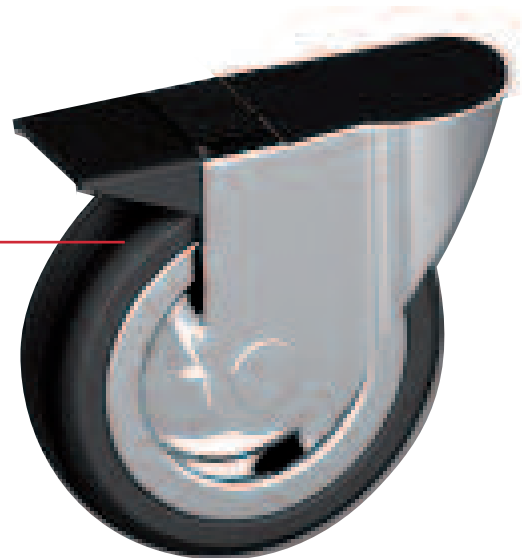



Ambiente Environment



Da molti anni MEPRA ha a cuore la salute dell'ambiente e dei lavoratori e l'uso sostenibile delle risorse ambientali, spesso anticipando di decenni le normative europee sul lavoro e sull'ambiente, investendo e puntando su impianti sempre più sicuri, alla ricerca di materiali e prodotti ausiliari sempre meno pericolosi, a garanzia della sicurezza e della salute del personale addetto e della comunità all'interno della quale l'azienda opera. Nei primi anni '80 del secolo scorso, gli impianti di lavaggio dei manufatti intermedi e finiti che utilizzavano solventi clorurati, vengono interamente rimpiazzati da impianti automatici che utilizzano sgrassanti a base acquosa (tunnel di lavaggio a tappeto). Nello stesso periodo gli impianti di pulitura e lucidatura della posateria manuali, vengono sostituiti da macchinari automatici a ciclo continuo, dotati di impianti di aspirazione e di abbattimento polveri. Negli anni '90, MEPRA, sempre più attenta alle tematiche ecologiche, trasforma i suoi impianti di lavaggio con soluzioni sgrassanti a base acquosa, che utilizzano e scaricano l'acqua per il lavaggio dei pezzi, in impianti che riciclano interamente le acque di lavaggio, filtrandole e re-immettendole nel ciclo senza alcuno scarico negli impianti fognari. Nel 1999 MEPRA con spirito innovativo si proietta verso il futuro, dotandosi di un sistema energetico altamente tecnologico; viene infatti installato un impianto di COGENERAZIONE. Viene utilizzato il metano come combustibile pulito, si genera elettricità per l'uso interno, si recupera il calore sprigionato dalla produzione elettrica, per il riscaldamento dei cicli produttivi che assorbono calore ed inoltre per il riscaldamento ambientale durante l'inverno, in modo da diminuire drasticamente l'inquinamento atmosferico prodotto dai gas serra. MEPRA rifiuta categoricamente ogni forma di sfruttamento del lavoro minorile ed investe ogni giorno per offrire alle nuove generazioni un futuro migliore, collaborando con le università e le scuole secondarie della comunità locale per formare i manager e i tecnici del futuro e per sostenere il mantenimento e l'accrescimento della cultura del lavoro, dei valori e delle competenze professionali che rappresentano una delle caratteristiche peculiari del distretto industriale all'interno del quale l'azienda opera.

Since many years MEPRA cares about the health of workers and the environment and sustainable use of environmental resources, often decades ahead of European regulations on labor and environment. Mepra invests and focus on safer and safer equipments, looking for materials and auxiliary products less and less dangerous, to guarantee safety and health of the workers as well as the community within which it operates. In the early 80s of last century, the washing equipment, previously based on chlorinated solvents, are entirely replaced by automatic systems that use water-based washing tunnels. In the same period the hand operated cutlery cleaning and polishing machineries, are replaced by continuous loop automatic machines, equipped with suction pumps and dust abatement equipment. In the '90s, MEPRA, more and more careful about the environment, converts washing systems previously using water-based degreasing solutions that were filtered and discharged into the sewers, into equipments that recycle the wastewaters by filtering and re-pumping them in the washing cycle without any waste in sewage plants. MEPRA in 1999 with an innovative spirit is projected into the future, adopting a high-tech energy system, a cogeneration system is in fact installed. It uses natural gas as clean fuel, electricity can be generated for internal use, it re-uses the heat generated from electricity production in production cycles and also for heating the plant during the winter, in order to drastically reduce carbon emissions. MEPRA categorically rejects all forms of child labor and invest every day to offer the new generations a better future, working with universities and secondary schools in the local community to train managers and technicians of the future and to carry-on work culture, values and skills that represent one of the characteristics of the industrial district in which the company operates.

CERTIFICATO SISTEMA DI GESTIONE

Certificato n.: 100305/1372-MSC-ACCREDIA-ITA Data Prima Emissione: 28 agosto 2020 Validità: 28 agosto 2020 - 27 agosto 2023

Si certifica che il sistema di gestione di

Mepra S.p.A.
Via Virgilio Montini, 176 - 25067 Lumezzane (BS) - Italia

È conforme allo Standard:
ISO 9001:2015

Questa certificazione è valida per il seguente campo applicativo:
Progettazione, produzione e commercializzazione di: posateria, pentolame, vasellame ed oggettistica in acciaio inox per la tavola e la cucina per uso domestico, Hotel, Ristoranti e Catering (IAF 17)

Luogo e Data:
Vimercate (MB), 28 agosto 2020



ACCREDIA
Istituto Italiano di Accreditamento

ACCREDITAZIONE
SISTEMI DI GESTIONE
E SISTEMI INTEGRATI
PER LE ATTIVITÀ DI PRODUZIONE
E SERVIZI
E PER LE ATTIVITÀ DI PRODUZIONE
E SERVIZI
E PER LE ATTIVITÀ DI PRODUZIONE
E SERVIZI

Per:
DNV GL - Business Assurance
Via Energy Park, 14, - 20871 Vimercate (MB) - Italy

Zeno Beltrami
Zeno Beltrami
Management Representative

Il mancato rispetto delle condizioni stabilite nel regolamento di certificazione potrebbe invalidare il certificato.
Per informazioni: 02-83461000 (ore ufficio) - 02-83461001 (ore ufficio) - 02-83461002 (ore ufficio) - 02-83461003 (ore ufficio) - 02-83461004 (ore ufficio)

MANAGEMENT SYSTEM CERTIFICATE

Certificate No.: 100305/1372-MSC-ACCREDIA-ITA Initial certification date: 28 August 2020 Valid: 28 August 2020 - 27 August 2023

This is to certify that the management system of

Mepra S.p.A.
Via Virgilio Montini, 176 - 25065 Lumezzane (BS) - Italy

has been found to conform to the Quality Management System standard:
ISO 9001:2015

This certificate is valid for the following scope:
Design, production and commercialisation of: flatware, cookware, serverware and items in stainless steel for the table and kitchen for domestic use, Hotels, Restaurants and Catering (IAF 17)

Place and date:
Vimercate (MB), 28 August 2020



ACCREDIA
Istituto Italiano di Accreditamento

ACCREDITAZIONE
SISTEMI DI GESTIONE
E SISTEMI INTEGRATI
PER LE ATTIVITÀ DI PRODUZIONE
E SERVIZI
E PER LE ATTIVITÀ DI PRODUZIONE
E SERVIZI
E PER LE ATTIVITÀ DI PRODUZIONE
E SERVIZI

For the issuing office:
DNV GL - Business Assurance
Via Energy Park, 14, - 20871 Vimercate (MB) - Italy

Zeno Beltrami
Zeno Beltrami
Management Representative

Il mancato rispetto delle condizioni stabilite nel regolamento di certificazione potrebbe invalidare il certificato.
Per informazioni: 02-83461000 (ore ufficio) - 02-83461001 (ore ufficio) - 02-83461002 (ore ufficio) - 02-83461003 (ore ufficio) - 02-83461004 (ore ufficio)

Abbiamo a cuore l'ambiente e il futuro del genere umano
Sin dal 1947 Mepra si trova ai piedi delle Prealpi Italiane. Siamo cresciuti e viviamo ogni giorno in simbiosi con le nostre montagne, abbiamo a cuore i nostri alberi, le nostre acque e l'aria che noi e i nostri figli respiriamo.

Nella lotta al cambiamento climatico ogni voce conta, anche la più piccola, in ogni angolo del mondo, e sentiamo la responsabilità di fare la nostra parte per assicurare un futuro migliore al pianeta.

Riduzione delle Emissioni di CO2

Con l'obiettivo di ridurre drasticamente le emissioni di CO2 Mepra si è impegnata ad installare un impianto fotovoltaico per produrre oltre 160.000 KWh all'anno e ridurre di conseguenza le emissioni di CO2 di 84.000 Kg. Il fabbisogno energetico residuo, nei mesi invernali, viene prodotto, per la maggior parte, con un sistema di cogenerazione. Questo impianto produce elettricità e, allo stesso tempo, il calore necessario per il riscaldamento dei locali aziendali, con un significativo risparmio energetico.

Riciclo

La maggior parte dell'acciaio utilizzato da Mepra nel processo produttivo proviene da fonti riciclate

Tutto lo scarto di produzione viene riciclato per produrre nuova materia prima

Gestione e recupero dei rifiuti

Mepra è da anni impegnata nella raccolta differenziata, non solo degli imballaggi, ma di tutti i rifiuti prodotti in azienda.

Conservazione delle risorse idriche

Dai primi anni '90 Mepra utilizza, all'interno del suo ciclo produttivo, un sistema di recupero dell'acqua di lavaggio e dei detergenti che vengono filtrati e re-immessi nel ciclo idrico senza alcuno scarico negli impianti fognari.

Utilizzo di sostanze non inquinanti:

Già dai primi anni '80, gli impianti di lavaggio dei manufatti intermedi e finiti che utilizzavano solventi clorurati, sono stati interamente rimpiazzati da impianti automatici che utilizzano sgrassanti a base acquosa (tunnel di lavaggio a tappeto).

Depurazione dell'aria

Nello stesso periodo gli impianti manuali di pulitura e lucidatura della posateria, sono stati sostituiti da macchinari automatici a ciclo continuo, dotati di impianti di aspirazione e di abbattimento polveri.

We have the future of the environment and the human species at heart

Since 1947 Mepra has been located at the foothill of the Italian pre Alps. We grew with and live in symbiosis with our mountains, day in day out, we care for our trees, our waters and the air we and our children breathe. In the fight against climate change every voice counts, even the faintest one, in every corner of the earth, and we feel the responsibility to play our part to ensure a better future for our planet.

Reduction of CO2 emissions

In the quest of drastically reducing CO2 emissions, Mepra has been working hard on the installation of a photovoltaic plant to produce more than 160.000 KWh per year, thus reducing CO2 emissions by 84.000 Kg.

The residual energy requirement in the winter months is produced for the most part by a cogeneration system that at the same time produces electricity and the necessary heat to heat up the offices, resulting in a significant energy saving.

Recycling

The majority of the steel used by Mepra in the production process comes from recycled sources. All the production waste is recycled to produce new raw material.

Waste management and recovery

For years Mepra has been practicing differentiated waste collection, not only with packaging, but all waste produced by the company.

Conservation of water resources

Since the early '90s Mepra uses a system that recovers the washing water and detergents used in production, by filtering them and re-introducing them in the water cycle without any discharge into the sewage system.

Use of non-polluting substances

Since the beginning of the 80's the washing machinery of the intermediate or finished products that used chlorinated solvents have entirely been replaced by automated machinery that use water-based degreasers.

Air purification

Always in the 80's the cleaning and polishing machinery used for cutlery have been replaced by automated loop machines equipped with dust suction and elimination systems.

B O B

BOB

AIUTA IL NOSTRO PIANETA
RIDUCI LA PLASTICA

Abbiamo creato una nuova linea di bottiglie riutilizzabili per garantire un futuro ai nostri oceani.

Per questo motivo il nome 'BOB = Blue Ocean Bottle', un progetto che ci aiuterà a ridurre l'utilizzo della plastica eliminando il consumo di bottiglie quotidiane.

BOB non è una semplice bottiglia termica, è l'esempio perfetto di utilità e eleganza fusi insieme.

We have created a new line of reusable bottles to grant a future to our oceans.

Hence the name "BOB = Blue Ocean Bottle", a project that will help us reduce the use of plastic by eliminating the consumption of daily plastic bottles. BOB is not a simple thermal bottle, it is the perfect example of utility and elegance fused together.

Perchè scegliere BOB? Why BOB?



Aiuta la salvaguardia dei nostri oceani.
Helps safeguard of our oceans.



Ferma il single use delle bottiglie di plastica.
Stops the single use of plastic bottles.



Diminuisce i batteri ingeriti che si annidano nelle bottiglie di plastica.
Reduces the ingested bacteria lurking in plastic bottles.



Durabilità nel tempo.
Longevity over time



Grazie al suo molteplici utilizzo, è un'ottima scelta per risparmiare denaro.
Can be used multiple times and is an excellent way to save money.



BLUE OCEAN BOTTLE

BOB è una bottiglia termica di capacità 0,5 litri. Grazie alla doppia camera in acciaio inossidabile, mantiene la temperatura della bevanda calda 12h e fredda fino a 24h.

BOB è in grado di contenere qualsiasi bevanda, dall'acqua ai succhi di frutta, senza rischio di corrosioni o alterazioni.

BOB is a thermal bottle with 0.5 liter capacity . Thanks to its double stainless steel chamber, it keeps the hot temperature for 12 hours and the cold one for up to 24 hours.

BOB is able to hold any drink, from water to fruit juices, without the risk of corrosion or alterations.



Chiusura Termica

Thermal Closure

Bilaminato acciaio e rame

Bi-laminated steel and copper

Camera sotto vuoto

Vacuum room

Corpo esterno di protezione

External protection body

Triplo fondo

Triple bottom



COLORI DISPONIBILI
 AVAILABLE COLORS
 COULEURS DISPONIBLE
 VERFÜGBARE FARBEN
 COLORES DISPONIBLE:

W
 Bianco
 White
 Blanc
 Weiss
 Blanco



O7
 Arancio
 Orange
 Orange
 Orange
 Naranja



S7
 Rosso
 Red
 Rouge
 Rot
 Rojo



693

BOB
 Bottiglia termica
 Insulated bottle
 Bouteille thermique
 Isolier Flasche
 Botella térmica

lt. 0,5
 oz. 16 7/8

H7
 Lilla
 Lilac
 Lilas
 Lila
 Lila



Q7
 Oliva
 Olive
 green
 Olive
 Olivegrün
 Oliva



D7
 Lavanda
 Lavendal
 Lavande
 Lavendal
 Lavanda



O
 Oro
 Gold
 Or
 Gold
 Oro



B
 Rame
 Copper
 Cuivre
 Kupfer
 Cobre



N
 Nero
 Black
 Noir
 Schwarz
 Negro



You can save the oceans too, one bottle at a time!





INDICE

INDEX

INDEX

ALPHABETISCHES REGISTER

INDICE

NUMERI

RESTAURANT
HOTEL

Indice

| A B | Pag |
|----------------------|-------------------------------------|
| Agitatore | 301 |
| Agitatore Boston | 301 |
| Allacciatovaglioli | 130 259 |
| Alzata dolci | 173 177 216 217 220 221 227 266 288 |
| Alzata pane | 234 235 289 |
| Alzata pesce crudo | 158 159 160 223 231 |
| Alzata portafrutta | 158 159 216 217 220 231 266 |
| Alzata portapiatti | 221 287 |
| Alzata torta | 173 177 216 230 266 |
| Ampolla | 219 239 242 268 |
| Antipastiera | 248 258 |
| Appoggia borse | 284 |
| Appoggia chop sticks | 82 |
| Appoggia posate | 84 102 173 177 195 209 |
| Apribottiglie | 282 |
| Apriostriche | 160 |
| Base per buffet | 196 197 |
| Bicchiere | 154 178 202 206 340 341 346 |
| Big champagnera | 310 |
| Bistecchiera | 333 |
| Bollilatte | 337 |
| Bottiglia termica | 368 <> 371 |
| Braciere con griglia | 242 244 |
| Bricco | 147 293 |
| Brocca per acqua | 294 0 |
| Bugia | 227 0 |

| C | Pag |
|------------------------------------|---|
| Caffettiera | 220 291 292 294 295 296 |
| Caffettiera termica | 291 292 296 |
| Candelabro | 221 227 |
| Caraffa per bibite | 199 291 292 294 |
| Caraffa termica | 291 292 |
| Carrello portavivande | 348 <> 362 |
| Casseruola | 322 324 326 331 334 |
| Cavatappi | 282 |
| Centrotavola | 155 158 159 161 189 202 |
| Cestino | 125 126 128 129 130 135 146 149 150 151 152 153 155 172 174 176 177 182 186 193 195 202 218 234 235 237 259 262 263 265 280 342 346 |
| Cestino portabonbon | 180 182 265 |
| Cestino portacondimenti | 135 262 277 280 |
| Cestino portafrutta | 135 146 149 150 151 152 153 155 234 237 262 265 308 309 342 346 |
| Cestino portapane | 135 146 149 150 151 186 193 195 218 234 235 237 259 262 265 280 342 |
| Cestino portatovaglioli | 193 234 289 298 |
| Cesto porta agrumi | 135 146 149 150 151 152 153 155 234 237 262 265 308 309 342 346 |
| Chafing dish | 208 210 |
| Champagnera | 152 223 233 310 314 315 |
| Chillcup | 219 238 |
| Chop sticks | 82 |
| Ciambella termica | 249 251 |
| Ciotola in acciaio | 146 216 237 277 |
| Ciotola in legno | 277 |
| Ciotola in policarbonato | 135 309 310 340 342 343 |
| Ciotola in polipropilene | 346 |
| Cloche | 221 223 224 236 251 273 276 281 |
| Coffee Urn | 209 |
| Colapasta | 337 |
| Colino da cocktail | 282 |
| Colonna porta big champagnera | 311 |
| Colonna portasecchiello | 126 128 135 153 222 232 233 302 303 304 305 306 307 309 315 |
| Colonna portasigari | 154 |
| Coltelli | 14 <> 72 86 88 104 118 160 243 |
| Contenitore per bibite | 199 209 |
| Coperchio | 224 272 274 |
| Coperchio per legumiera e zuppiera | 224 274 |
| Coperchio per piatto ovale | 272 |
| Coppa burro | 219 238 |
| Coppa caviale | 219 238 |
| Coppa cocktail e scampi | 219 238 |
| Coppa con piede | 146 147 216 218 223 237 301 |
| Coppa con vassoio | 178 180 182 219 225 238 |
| Coppa crema/potage | 274 |
| Coppa intermezzo | 100 278 |
| Coppa in vetro | 218 249 |
| Coppa lavadita | 146 276 |
| Coppa Martini | 278 341 |
| Coppa multiservizio | 218 |
| Coppa per champagne | 223 227 301 |
| Coppa per gelato e/o macedonia | 147 180 182 225 237 238 280 288 341 |
| Coppa per pinzimonio | 218 249 |
| Coppa per punch | 223 227 301 |
| Coppa vichyssoise | 219 238 274 |
| Coppetta amouse bouche | 102 178 |
| Copripiatto | 270 273 |
| Cremiera | 154 248 288 299 |

| C | Pag |
|---------------------------|------------------------------|
| Cubetto luminoso LED | 317 |
| Cucchiaino da cocktail | 14 <> 72 102 206 |
| Cucchiaino per cappuccino | 104 299 |
| Cucchiaino per caviale | 282 |
| Cucchiaino sale | 102 206 |
| Cucchiaino agitatore | 14 <> 72 104 106 299 316 |
| Cucchiaino monoporzione | 102 206 |
| Cucchiaino multifunzione | 96 163 |
| Cucchiaino per bibita | 14 <> 72 104 106 299 316 |
| Cucchiaino per insalata | 14 <> 72 106 119 209 210 |
| Cucchiaino per miele | 98 |
| Cucchiaino per parmigiano | 14 <> 72 |
| Cucchiaino per risotto | 104 106 119 209 210 |
| Cucchiaino per salsa | 14 <> 72 119 210 274 |
| Cucchiaino servire | 14 <> 72 104 106 119 209 210 |
| Culla porta champagne | 211 |
| Cuocipasta | 337 |
| Cuociverdura | 337 |

| DEF | Pag |
|---------------------------------|---|
| Distributore di latte | 209 |
| Distributore di succo di frutta | 209 |
| Dosatore sale e pepe | 154 |
| Dosatore | 301 |
| Espositore per buffet | 202 |
| Finger food | 102 106 133 162 <> 167 172 176 185 195 202 206 212 94 104 |
| Forchetta aragosta | 94 104 |
| Forchetta monoporzione | 102 172 176 206 |
| Forchetta per insalata | 14 <> 72 106 119 209 210 |
| Forchetta per lumache | 104 |
| Forchetta servire | 14 <> 72 104 106 119 209 210 |
| Forchetta servire pesce | 14 <> 72 106 119 |
| Forchettina ostriche | 14 <> 72 |
| Forchettina cocktail | 102 172 176 206 |
| Forchettone | 14 <> 72 104 106 119 209 210 |
| Formaggiera | 133 219 239 259 260 262 263 265 269 276 |
| Fruttiera | 155 158 159 161 189 |

| GHIL | Pag |
|-------------------------|-------------------------|
| Glacette termica | 304 |
| Golf club mixer spoon | 104 316 |
| Grattugia | 282 |
| Gueridon d'appoggio | 308 |
| Happy spoon | 106 |
| Infusiera | 199 |
| Inserto per cuocipasta | 337 |
| Insalatiera | 146 216 237 249 342 346 |
| Inserto per finger food | 133 165 |
| Lasagnera | 249 258 |
| Lattiera | 220 291 292 294 295 296 |
| Legumiera | 224 274 |
| Legumiera escoffier | 274 |

| MNO | Pag |
|---------------------------------|---|
| Macine | 283 |
| Mestolo | 14 <> 72 106 210 301 |
| Micro forchetta | 102 172 176 |
| Micro presentoire | 163 288 |
| Mini burriera | 144 225 239 264 267 277 288 |
| Mini casseruola | 322 324 326 |
| Mini cestello | 177 |
| Mini forchetta | 102 206 |
| Mini presentoire | 163 288 |
| Mini spoon | 102 206 |
| Mini vaporiera | 166 |
| Mini vassoio | 164 181 182 183 202 220 |
| Misurino cocktail | 301 |
| Molla fonda per servire | 212 |
| Molla per aperitivi | 212 293 |
| Molla per asparagi | 147 212 275 |
| Molla per arrosto e verdure | 147 212 275 |
| Molla per dolci | 212 275 |
| Molla per Finger Food | 212 |
| Molla per frutta | 212 275 |
| Molla per ghiaccio | 212 275 316 |
| Molla per ghiaccio e limone | 212 |
| Molla per lumache | 104 275 276 |
| Molla per pane | 212 |
| Molla per pasticceria | 212 |
| Molla per servire | 212 275 |
| Molla per spaghetti | 147 212 275 |
| Molla per zucchero | 212 275 293 |
| Molla per zucchero ed aperitivi | 212 293 |
| Molla piana per servire | 212 |
| Mug | 343 |
| Numero da tavola | 185 223 237 278 281 |
| Oliera | 133 225 239 259 260 262 263 265 268 269 |

| PQR | Pag |
|----------------|--------------------------|
| Padella | 323 325 327 331 332 336 |
| Pala per torta | 14 <> 72 106 118 209 210 |
| Pentola | 322 324 326 331 334 |
| Petit marmite | 208 |

Indice

| P Q R | Pag |
|-----------------------------------|--|
| Piano | 130 149 150 151 189 202 206 340 |
| Piastra ad induzione ed elettrica | 208 |
| Piastra eutettica | 358 359 |
| Piattino | 171 176 238 343 |
| Piattino per burro | 264 267 |
| Piattino per lumache | 276 |
| Piattino per mug | 343 |
| Piattino per pane | 149 267 |
| Piattino per pasticceria | 179 181 182 |
| Piattino porta monete | 176 301 |
| Piattino sottocoppa | 238 |
| Piatto concavo | 193 235 |
| Piatto da presentazione | 134 146 149 151 165 186 194 257 263 264 266 283 346 |
| Piatto da torta | 218 230 |
| Piatto ovale | 144 146 270 272 |
| Piatto per buffet | 340 |
| Piatto per legumi | 146 272 |
| Piatto per ostriche | 158 159 161 |
| Piatto pesce | 144 270 |
| Piatto quadrato | 150 202 248 |
| Piatto rotondo | 144 146 206 251 270 272 340 |
| Piatto termico | 251 |
| Pietra ollare | 242 |
| Pinza aragosta | 104 |
| Pinza per antipasti e dolci | 212 275 293 |
| Pinza per dolci | 212 275 |
| Pinza per servire | 147 212 275 |
| Pinza per torta | 212 275 |
| Pinza per verdure | 147 212 275 |
| Pirofile e porcellane | 249 258 |
| Poggia pane | 178 |
| Porta badge | 281 |
| Porta bastoncini di zucchero | 298 |
| Porta bicchieri | 259 |
| Porta bottiglie | 277 279 |
| Porta burro e marmellata | 277 299 |
| Porta bustine da zucchero | 193 220 234 289 296 298 299 |
| Porta cannuce | 316 |
| Porta condimenti | 135 262 277 280 |
| Porta cono gelato | 165 242 |
| Porta crackers | 178 |
| Porta cucchiaini | 301 |
| Porta gioie | 170 176 |
| Porta grissini | 151 178 186 193 195 279 |
| Porta macarons | 219 267 288 |
| Porta marmellata | 225 269 299 |
| Porta menù | 223 237 |
| Porta noccioli | 133 236 |
| Porta numero | 185 223 237 278 281 |
| Porta pane porta grissini | 151 178 185 186 193 195 279 |
| Porta pasticcini | 216 217 227 266 288 |
| Porta patatine fritte | 165 242 278 |
| Porta piatti | 221 259 287 |
| Porta salatini | 219 287 342 343 |
| Porta salse | 280 |
| Porta salviettine | 299 |
| Porta sapone | 299 |
| Porta sigari | 154 |
| Porta sorpresa | 170 176 |
| Porta spazzolini | 301 |
| Porta spezie | 258 |
| Porta stuzzicadenti | 185 195 219 225 234 239 268 269 274 280 |
| Porta tacos | 279 |
| Porta toast | 278 288 |
| Porta tovaglioli | 192 193 234 258 289 298 |
| Porta uovo | 144 277 |
| Porta vivande | 208 210 |
| Portaghiaccio termico | 232 304 305 306 |
| Posacenere | 151 154 276 |
| Posate | 14 <> 72 86 88 96 98 102 104 106 118 119 160 163 176 206 209 210 243 274 282 299 301 |
| Presentoire | 163 221 227 287 288 289 |
| Quarta posata | 90 <> 93 163 175 |
| Rechaud | 208 210 |
| Rinfresca macedonia | 223 |
| Rinfrescatore per yogurt | 210 223 |
| Rinfrescavino bianco | 304 305 307 |
| Risottiera | 258 320 324 326 331 333 |

| S | Pag |
|---------------------------------|---|
| Salino | 219 269 |
| Salsiera | 144 274 |
| Salvagoccia | 279 |
| Saucière | 144 178 |
| Sauteuse | 246 |
| Schiaccianoci | 282 |
| Scodella lavadita | 146 276 |
| Secchiello per ghiaccio | 146 152 153 222 232 301 302 303 304 305 306 308 314 316 317 346 |
| Secchiello per ghiaccio termico | 232 304 305 306 |
| Secchiello per spumante | 126 146 152 153 186 222 232 301 302 303 304 305 306 307 308 309 310 314 316 317 342 346 |

| S | Pag |
|------------------------------|--|
| Segnaposto | 278 |
| Servizio per antipasto | 219 |
| Servizio per caffè | 224 293 |
| Servizio per caviale | 238 |
| Servizio per champagne | 305 |
| Servizio per latte macchiato | 299 |
| Servizio per olio e aceto | 262 277 280 |
| Servizio per pinzimonio | 249 |
| Servizio per zucchero | 225 267 287 293 |
| Set impilabile | 342 343 |
| Set per aperitivi | 133 |
| Set per ceviche | 281 |
| Set sale e pepe | 154 225 239 268 269 274 |
| Sottobicchiere | 257 264 267 |
| Sottobottiglia | 185 186 195 257 264 267 283 |
| Sottopiatto | 134 146 149 151 165 186 194 257 263 264 266 283 346 |
| Spaghiettiera | 337 |
| Spargipepe | 154 |
| Spargisale | 154 219 225 239 268 269 274 |
| Spumantiera | 152 233 310 314 315 |
| Street cover | 138 140 |
| Supporto | 248 249 |
| Supporto per informazioni | 223 237 |

| T V W Z | Pag |
|-----------------------------------|--|
| Taglia tartufi | 283 |
| Tazza | 343 |
| Tegame | 320 324 326 331 333 334 |
| Tegamino friggiuova | 147 276 |
| Teiera | 220 291 292 294 295 296 |
| Teiera termica | 296 |
| Tiffin' box | 252 |
| Tovaglietta americana | 134 138 140 185 194 |
| Trolley | 348 <> 363 |
| Tube per ghiaccio | 199 |
| Tumbler | 178 |
| Vaporiera | 166 |
| Vasetto portafiori | 283 |
| Vaso | 171 176 346 |
| Vassoietto | 181 182 183 220 |
| Vassoio | 123 133 134 144 150 158 159 161 164 165 175 177 179 180 181 182 185 186 189 192 194 195 202 206 209 215 218 228 229 230 234 235 236 254 257 260 262 263 264 272 273 279 280 288 289 298 |
| Vassoio concavo | 279 |
| Vassoio conto | 151 |
| Vassoio gn | 185 186 194 215 228 |
| Vassoio in carbonio | 122 123 |
| Vassoio ovale | 150 159 164 189 218 230 263 273 |
| Vassoio per carrelli | 186 235 254 |
| Vassoio petit four | 179 180 181 182 183 |
| Vassoio portabicchieri impilabile | 235 |
| Vassoio prima colazione | 133 |
| Vassoio quadrato | 134 150 158 164 165 185 195 202 229 257 262 |
| Vassoio rettangolare | 123 133 134 144 150 158 164 185 186 189 192 194 195 202 206 209 215 218 228 229 230 234 235 236 254 257 260 262 263 264 272 273 279 280 288 289 298 |
| Vassoio rotondo | 159 161 175 177 215 218 229 230 236 257 260 264 |
| Versatore per profumo | 225 |
| Vetrina (cupola) refrigerata | 358 359 |
| Wok | 333 337 |
| Zuccheriera | 147 154 220 291 292 294 295 296 298 299 |
| Zuppiera | 208 224 274 |
| Zuppiera monoporzione | 274 |

Index

A B

| | Pag |
|--------------------------------|--|
| Accessories | 82 <> 107 |
| Afternoon tea stand | 221 287 |
| Amenities tray | 133 134 135 165 186 234 289 299 |
| Appetizer bowl | 133 178 |
| Appetizer set | 133 |
| Asparagus tongs | 147 212 275 |
| Bags support | 284 285 |
| Bar spoon | 104 106 299 316 |
| Basket for aromatic condiments | 260 277 280 |
| Beverage server | 199 291 292 293 294 |
| Beverage server, insulated | 291 292 |
| Big wine party tub | 152 223 233 310 314 315 |
| Boston shaker | 301 |
| Bottle cooler | 304 |
| Bottle, insulated | 368 <> 371 |
| Bottle opener | 282 |
| Bottle stand/coaster | 185 186 195 254 262 264 283 |
| Bowl | 146 149 150 151 177 178 182 202 216 218 225 235 237 259 277 309 340 342 343 346 309 310 342 |
| Bowl, small | 102 146 178 180 216 218 237 277 342 343 346 |
| Bread basket | 135 146 149 150 151 186 193 195 218 234 235 237 259 262 265 280 342 |
| Bread plate | 149 267 |
| Bread stand | 192 234 289 |
| Bread/Pastry tongs | 212 |
| Breakfast tray | 133 |
| Buffet rack | 202 340 |
| Buffet showcase, cooled | 358 359 |
| Butter cup and dish | 219 238 264 267 277 299 |

C

| | |
|--|---|
| Cafè au lait set | 224 293 299 |
| Cake server | 14 <> 72 106 118 209 210 |
| Cake stand | 173 177 216 217 220 221 227 266 288 |
| Candlestick | 221 227 |
| Carbon fiber tray | 122 123 |
| Carving fork | 16 <> 72 104 119 |
| Cash tray | 176 301 |
| Caviar cup | 219 238 |
| Caviar set | 238 |
| Caviar spoon | 282 |
| Casserole | 322 324 326 331 334 |
| Centerpiece | 155 158 159 161 189 202 |
| Ceviche set | 281 |
| Chafing dish | 208 210 |
| Champagne bowl | 152 223 233 310 314 315 |
| Champagne bowl stand | 126 128 135 153 222 232 233 302 303 304 305 306 307 309 315 |
| Champagne bucket | 126 146 152 153 186 222 232 301 302 303 304 305 306 307 308 309 310 314 316 317 342 346 |
| Champagne holder | 211 |
| Charger | 134 146 149 151 165 186 194 257 263 264 266 283 346 |
| Chillcup | 219 238 |
| Chilli mill | 283 |
| Chips cone holder | 165 240 278 |
| Chopsticks | 82 |
| Chopsticks rest | 82 |
| Cigar ash tray | 151 154 276 |
| Cloche | 221 223 224 236 251 273 276 281 |
| Cloche for wedding cake stand | 224 236 281 |
| Cocktail measuring cup double | 301 |
| Cocktail strainer | 282 |
| Coffee cup | 343 |
| Coffee dispenser solid alcohol heating | 209 |
| Coffee pot | 220 291 292 294 295 296 |
| Coffee pot, insulated | 291 292 296 |
| Coffee urn | 209 |
| Colander | 337 |
| Cookware | 318 <> 337 |
| Cooled juice pitcher | 291 292 294 |
| Cork screwer | 282 |
| Cover | 270 273 |
| Cover for oval meat dish | 270 |
| Cover for soup tureen and vegetable dish | 270 272 273 |
| Creamer | 154 248 288 299 |
| Cruet | 219 239 242 268 |
| Cruet set | 135 225 239 259 260 261 262 263 265 268 269 |
| Cup and tray | 178 180 182 219 225 238 |
| Cup with feet | 146 147 216 218 223 237 301 |

DEF

| | |
|-----------------------|---------------------------------|
| Deep serving tongs | 275 |
| Dish cover | 270 273 |
| Dome cover for dish | 221 223 224 236 251 273 276 281 |
| Egg cup | 144 277 |
| Electric heating unit | 208 |
| Escargot fork | 104 |
| Escargot plate | 276 |

DEF

| | |
|----------------------------|---|
| Escargot tongs | 104 275 276 |
| Eutectic pads | 357 358 |
| Finger bowl | 146 276 |
| Finger food | 102 106 133 162 <> 167 172 176 185 195 202 206 212 |
| Finger food insert | 133 164 |
| Finger food tongs | 212 |
| Fish dish | 144 270 |
| Fish serving fork | 14 <> 72 106 119 |
| Fish serving knife | 14 <> 72 106 119 |
| Flat serving tongs | 212 |
| Flatware | 14 <> 72 86 88 96 98 102 104 106 118 119 163 206 209 210 243 282 |
| Flower vase | 283 |
| Food pan | 204 206 |
| French fry holder | 165 241 278 |
| Front cooking & Apartments | 318 <> 337 |
| Fruit basket | 151 155 158 159 189 202 |
| Fruit bowl | 135 146 149 150 151 152 153 155 234 237 262 265 308 309 342 346 146 216 237 340 342 |
| Fruit salad bowl | 158 159 216 217 220 231 266 |
| Fruit stand | 212 275 |
| Fruit tongs | 323 325 327 331 332 336 |
| Frying pan | 147 276 |
| Frying pan for eggs | 147 276 |

GHIJKL

| | |
|---------------------------------|--|
| Giant champagne bucket | 310 |
| Glass | 154 178 202 206 340 341 346 |
| Glass coaster | 257 264 267 |
| Golf club mixer spoon | 104 316 |
| Grated cheese pot | 133 219 239 259 260 262 263 265 269 276 |
| Grater | 282 |
| Gravy boat | 140 268 |
| Grill | 333 |
| Gueridon | 308 |
| Happy spoon | 106 |
| Herbs mill | 283 |
| Holder | 223 237 248 249 |
| Honey spoon | 98 |
| Hors d'oeuvre tray | 248 258 |
| Hors d'oeuvre and pastry pliers | 275 276 |
| Ice and lemon tongs | 212 |
| Ice bucket | 146 152 153 222 232 301 302 303 304 305 306 308 314 316 317 346 |
| Ice bucket, insulated | 232 304 305 306 |
| Ice cream cup | 147 180 182 225 237 238 280 288 341 |
| Ice tea spoon | 14 <> 72 77 106 295 312 |
| Ice tongs | 212 275 316 |
| Intermezzo cup | 100 278 |
| Infuser jug | 199 |
| Infuser jug insert | 199 |
| Induction cooker | 208 |
| Jam and honey holder | 225 269 |
| Jar | 176 |
| Jug | 147 291 292 293 |
| Juice dispenser | 209 |
| Kitchen set | 334 |
| Knife rest | 84 102 173 177 195 209 |
| Knives | 14 <> 72 86 88 104 118 160 243 |
| Ladle | 14 <> 72 106 210 301 |
| LED Ice cubes | 317 |
| Lobster cracker | 104 |
| Lobster pick | 94 |

MNO

| | |
|----------------------------|--|
| Meat dish | 144 270 |
| Micro fork | 102 172 176 |
| Micro and Mini presentoire | 163 288 |
| Milk boiler | 337 |
| Milk dispenser | 209 |
| Milk pot | 220 291 292 294 295 296 |
| Mini basket | 177 |
| Mini butter dish | 144 225 239 277 288 |
| Mini casserole | 322 324 326 |
| Mini fork | 102 206 |
| Mini spoon | 102 206 |
| Mini steamer | 166 |
| Mini table stand | 281 |
| Mini tray | 164 181 182 183 202 220 |
| Mixing glass | 301 |
| Monoportion fork | 102 172 176 206 |
| Monoportion spoon | 102 172 176 177 206 |
| Mug | 343 |
| Multifunctional spoon | 96 163 |
| Multipurpose bowl | 218 |
| Napkin holder | 192 193 234 258 289 298 |
| Napkin ring | 130 259 |
| Nut-cracker | 282 |
| Oil and vinegar set | 262 277 280 |
| Oil pourer | 133 225 239 259 260 262 263 265 268 269 |

Index

M N O

| | |
|-----------------|-----------------|
| Olive seeds jar | 133 236 |
| Oval meat dish | 144 146 270 272 |
| Oval dish/china | 249 258 |
| Oyster fork | 14 <> 72 |
| Oyster plate | 158 159 161 |

P Q R

| | |
|-------------------------|---|
| Parmesan cheese basin | 133 219 239 259 260 262 263 265 269 276 |
| Parmesan spoon | 14 <> 72 |
| Party forks | 102 172 176 206 |
| Party spoon | 14 <> 72 |
| Pasta pot | 337 |
| Pasta pot insert | 337 |
| Pastry pliers | 212 275 |
| Pastry stand | 173 177 216 217 220 221 227 266 288 |
| Patè holder | 144 225 239 288 |
| Pepper grinder | 283 |
| Pepper shaker | 154 225 239 268 269 274 |
| Perfume drops dispenser | 225 |
| Petit four stand | 173 177 216 217 220 221 231 266 287 |
| Petit marmite | 208 |
| Pie pliers | 212 275 |
| Pinzimonio set | 249 |
| Plate cover, round | 271 271 272 273 |
| Plate, crescent | 193 235 |
| Plates | 144 146 149 171 176 179 181 182 193 218 230 235 238 248 264 267 270 272 276 301 343 |
| Pliers | 104 147 212 275 276 293 316 |
| Polycarbonate drinkware | 338 <> 341 |
| Porcelain insert | 249 258 |
| Presentoire | 163 221 227 287 288 289 |
| Punch bowl | 223 227 301 |
| Quarta Posata | 90 <> 93 163 175 |
| Relish dish | 219 287 342 343 |
| Riser | 196 197 |
| Room service system | 251 |

S

| | |
|----------------------------|--|
| Salad bowl | 146 216 237 309 342 346 |
| Salt and pepper set | 154 225 239 268 269 274 |
| Salt cellar | 219 269 |
| Salt grinder | 283 |
| Salt shaker | 154 225 239 268 269 274 |
| Salt spoon | 102 206 |
| Salt/Pepper dispenser | 154 225 239 268 269 274 |
| Sauce boat | 144 274 |
| Sauce bowl | 280 |
| Sauce spoon | 14 <> 72 106 |
| Saucepan | 322 324 326 331 334 |
| Saucer | 171 176 238 264 267 343 |
| Sauteuse | 246 |
| Seafood stand | 158 159 160 223 231 |
| Serving fork | 14 <> 72 104 106 119 209 210 |
| Serving pliers | 147 212 275 |
| Serving spoon | 14 <> 72 104 106 119 209 210 |
| Serving tongs | 147 212 275 |
| Set for Risotti | 258 |
| Shaker | 301 |
| Show plate | 134 146 149 151 165 186 194 257 263 264 266 283 346 |
| Small spoon | 102 206 |
| Snack server | 219 287 342 343 |
| Soapstone | 242 |
| Soap tray | 299 |
| Soup cup | 274 |
| Soup tureen | 208 224 274 |
| Spaghetti tongs | 147 212 275 |
| Square tray | 134 150 158 164 165 185 195 202 229 257 262 |
| Stackable tray | 228 229 235 |
| Stackable tray for glasses | 235 |
| Stock pot | 322 324 326 331 334 |
| Street cover | 139 141 |
| Sugar bowl | 147 154 220 291 292 294 295 296 298 299 |
| Sugar, milk and coffee set | 224 293 |
| Sugar set | 224 225 267 287 293 |
| Sugar tongs | 212 275 293 |
| Sugar and cocktails tongs | 212 293 |
| Sugar/Tea bags holder | 193 220 234 289 298 299 |
| Supreme cup | 219 238 |

T U V W Y

| | |
|--------------------|-------------------------|
| Table grill | 242 244 |
| Table mat | 134 138 140 185 194 |
| Table number | 185 223 237 278 281 |
| Table number stand | 185 223 237 278 281 |
| Tacos holder | 279 |
| Tall container | 125 126 128 146 153 186 |
| Tea cup | 343 |
| Tea pot | 220 291 292 294 295 296 |
| Tea pot, insulated | 296 |

T U V W Y

| | |
|--------------------------|--|
| Thermal serving unit | 249 251 |
| Tiffin' box | 252 |
| Toast rack | 278 288 |
| Toast/Pastry tongs | 212 275 |
| Tongs | 104 147 212 275 276 293 316 |
| Toothpick holder | 185 195 219 225 234 239 268 269 274 280 |
| Tray | 123 133 134 144 150 158 159 161 164 165 175 177 179 180 181 182 185 186 189 192 194 195 202 206 209 215 218 228 229 230 234 235 236 254 257 260 262 263 264 272 273 279 280 288 289 298 |
| Tray for rack trolley | 186 235 254 |
| Tray gn | 185 186 194 215 228 |
| Tray, oval | 150 159 164 189 218 230 263 273 |
| Tray, rectangular | 123 133 134 144 150 158 164 185 186 189 192 194 195 202 206 209 215 218 228 229 230 234 235 236 254 257 260 262 263 264 272 273 279 280 288 289 298 |
| Tray, round | 159 161 175 177 215 218 229 230 236 257 260 264 |
| Tray, square | 134 150 158 164 165 185 195 202 229 257 262 |
| Tray with holes | 177 |
| Trolley | 348 <> 363 |
| Truffle slicer | 283 |
| Tumbler | 178 |
| Underliner | 238 |
| Vacuum jug | 291 292 |
| Vase | 171 176 346 |
| Vegetable dish | 224 274 |
| Vegetable dish escoffier | 274 |
| Vegetable/Meat tongs | 147 212 275 |
| Vegetable pliers | 147 212 275 |
| Vegetable steamer | 337 |
| Vichyssoise cup | 219 238 274 |
| Vinegar dispenser | 219 239 242 268 |
| Water pitcher | 199 291 292 294 |
| Water pitcher, insulated | 291 292 |
| Wine cooler | 304 305 307 |
| Wine cooler stand | 126 128 135 153 222 232 233 302 303 304 305 306 307 309 315 |
| Wine holder | 211 277 |
| Wok | 333 337 |
| Yogurt cooler | 210 223 |

Index

A B

| | |
|---------------------------------|---------------------------------|
| Accessoires | 82 <> 107 |
| Ardoise | 242 |
| Assiette de bienvenue | 134 146 149 151 165 186 194 257 |
| | 263 264 266 283 346 |
| Batteries de cuisine | 334 |
| Beurrir | 144 225 239 277 288 |
| Bol | 125 126 128 129 130 135 146 149 |
| | 150 151 152 153 155 172 174 176 |
| | 177 182 186 193 195 202 218 234 |
| | 235 237 259 262 263 265 280 342 |
| | 346 |
| Bol à caviar | 219 238 |
| Bol à champagne | 223 227 301 |
| Bol à punch | 223 227 301 |
| Bol à rafraîchir | 210 223 |
| Bol à salade de fruits | 146 216 237 249 342 346 |
| Bol à sauce | 280 |
| Bol à snacks | 219 287 342 343 |
| Bol avec socle | 146 147 216 218 223 237 301 |
| Bol en bois | 277 |
| Bol en polycarbonate | 135 309 310 340 342 343 |
| Bol en polypropylène | 346 |
| Bol en verre | 218 249 |
| Bol universel | 102 178 |
| Boston shaker | 301 |
| Bouilleur | 209 |
| Bouilloire à lait | 337 |
| Borne étouffoir | 154 |
| Bouteille thermique | 368 <> 371 |
| Brasero avec pierres naturelles | 242 244 |
| But de canapé | 308 |

C

| | |
|---------------------------------------|---------------------------------|
| Cache eau mineral | 279 |
| Cafetière | 220 291 292 294 295 296 |
| Cafetière thermique | 291 292 296 |
| Carafe | 199 291 292 294 |
| Carafe à eau | 199 291 292 294 |
| Carafe à eau thermique | 291 292 |
| Cartouches eutectiques | 358 359 |
| Casse-noix | 282 |
| Cendrier | 151 154 276 |
| Cendrier à cigares | 151 154 276 |
| Centre de table/Comptoir | 155 158 159 161 189 202 |
| Chafing-dish | 208 210 |
| Chandelier | 221 227 |
| Chandelier/bougeoir | 227 |
| Chariot | 348 <> 363 |
| Chariot de service | 229 |
| Chopsticks | 82 |
| Cloche pour plat | 221 223 224 236 251 273 276 281 |
| Cloche pour plat ovale | 272 |
| Cloche pour plat rond | 221 236 251 273 276 |
| Cloche support à tartes | 224 236 281 |
| Coffee Urn | 209 |
| Conteneur à thé | 220 291 292 294 295 296 |
| Coquetier | 147 276 |
| Corbeille | 125 126 128 129 130 135 146 149 |
| | 150 151 152 153 155 172 174 176 |
| | 177 182 186 193 195 202 218 234 |
| | 235 237 259 262 263 265 280 342 |
| | 346 |
| Corbeille à pain | 135 146 149 150 151 186 193 195 |
| | 218 234 235 237 259 262 265 280 |
| | 342 |
| Corbeille pour aromatiques condiments | 135 262 277 280 |
| Corps de chauffe électrique | 208 |
| Coupe à beurre | 144 225 239 264 267 277 288 |
| Coupe à caviar | 219 238 |
| Coupe à creme/potage | 274 |
| Coupe à crevettes | 219 238 |
| Coupe à fruits | 147 180 182 225 237 238 280 288 |
| | 341 |
| Coupe à glace | 147 180 182 225 237 238 280 288 |
| | 341 |
| Coupe à intermezzo | 100 278 |
| Coupe à Martini | 278 341 |
| Coupe à punch | 223 227 301 |
| Coupe à suprême | 219 238 |
| Coupe à vichyssoise | 219 238 274 |
| Coupe multifonctions | 218 |
| Coupe sur pied | 146 147 216 218 223 237 301 |
| Coupe thermique à glace | 237 280 288 |
| Coupelle | 102 149 150 151 178 202 216 237 |
| | 276 277 342 343 346 |
| Coupe-truffes | 283 |
| Couteau à huîtres | 160 |
| Couteau à servir poisson | 14 <> 72 106 119 |
| Couteaux | 14 <> 72 86 88 104 118 160 |
| | 243 |
| Couvercle | 224 272 274 |
| Couvercle légumier | 224 274 |
| Couverts | 14 <> 72 86 88 96 98 102 |
| | 104 106 118 119 160 163 176 206 |
| | 209 210 243 274 282 299 301 |
| Couvre-plat | 270 273 |

C

| | |
|-----------------------------|------------------------------|
| Crémier | 154 248 288 299 |
| Cuiller à bar | 14 <> 72 104 106 299 316 |
| Cuillère à miel | 98 |
| Cuiller à risotto | 104 106 119 209 210 |
| Cuiller à servir | 14 <> 72 104 106 119 209 210 |
| Cuiller à soda | 14 <> 72 104 106 299 316 |
| Cuillèr cocktail | 14 <> 72 102 206 |
| Cuillère à glace | 14 <> 72 104 106 299 316 |
| Cuillère à parmesan | 14 <> 72 |
| Cuillère à sauce | 14 <> 72 119 210 274 |
| Cuillère à sel | 102 206 |
| Cuillère monoportion | 102 172 |
| Cuillère multifonctionnelle | 96 163 |
| Cuit pâtes | 337 |
| Curette à homard | 94 104 |

DEF

| | |
|-----------------------------|---------------------------------|
| Décapsuleur | 282 |
| Dessous de bouteille | 185 186 195 257 264 267 283 |
| Dessous de verre | 257 264 267 |
| Distributeur à jus | 209 |
| Distributeur à lait | 209 |
| Distributeur de serviettes | 192 193 234 258 289 298 |
| Doseur | 301 |
| Douser sel/poivre | 154 |
| Ecuelle | 146 276 |
| Élément pour cuit pâtes | 337 |
| Étagère | 158 159 160 177 182 216 217 223 |
| | 227 231 266 |
| Étiquettes | 185 223 237 278 281 |
| Faitout | 322 324 326 331 334 |
| Finger food | 102 106 133 162 <> 167 172 176 |
| | 185 195 202 206 212 |
| Fourchette amouse-bouche | 102 172 176 206 |
| Fourchette à escargots | 104 |
| Fourchette à fromage | 104 |
| Fourchette à huîtres | 14 <> 72 |
| Fourchette à servir | 14 <> 72 104 106 119 209 210 |
| Fourchette à servir poisson | 14 <> 72 106 119 |
| Fourchette cocktail | 102 172 176 206 |
| Fourchette monoportion | 102 172 176 206 |
| Fromagère | 133 219 239 259 260 262 263 265 |
| | 269 276 |

GHIL

| | |
|-------------------------|---------------------------------|
| Glacette thermique | 304 |
| Glaçon lumineux | 317 |
| Golfrosse pour cocktail | 104 316 |
| Gril | 333 |
| Huiliér | 219 239 242 268 |
| Huillier/vinaigrier | 133 225 239 259 260 262 263 265 |
| | 268 269 |
| Légumier | 224 274 |
| Légumier escoffier | 274 0 |
| Louche | 14 <> 72 106 210 301 |

MNO

| | |
|-------------------------|---------------------------------|
| Marmite traiteur | 322 324 326 331 334 |
| Ménagère | 133 225 239 259 260 262 263 265 |
| | 268 269 |
| Mesure à alcool, double | 301 |
| Micro fourchette | 102 172 176 |
| Mini corbeille | 177 |
| Mini faitoute | 322 324 326 |
| Mini marquer de table | 281 |
| Mini spoon | 102 206 |
| Mini plateau | 164 181 182 183 202 220 |
| Mini vaporisateur | 166 |
| Moulin à herbes | 283 |
| Moulin à piment | 283 |
| Moulin à poivre | 283 |
| Moulin à sel | 283 |
| Mug | 343 |
| Numéro de table | 186 223 237 278 281 |
| Ouvre-bouteilles | 282 |

PQ

| | |
|----------------------------|---------------------------------|
| Panier à fruits | 135 146 149 150 151 152 153 155 |
| | 234 237 262 265 308 309 342 346 |
| Passoire | 337 |
| Passoire à cocktail | 282 |
| Pelle à gâteau / à tarte | 14 <> 72 106 118 209 210 |
| Petit sous-plat | 149 171 176 238 267 301 343 |
| Petite marmite | 208 |
| Petite plateau | 164 181 182 183 202 220 |
| Pied pour bol a champagne | 311 |
| Pied pour seau à champagne | 126 128 135 153 222 232 233 302 |
| | 303 304 305 306 307 309 315 |
| Pince | 104 147 212 275 276 293 316 |
| Pince à amuse-bouche | 212 293 |
| Pince à asperges | 147 212 275 |
| Pince à escargots | 104 275 276 |
| Pince à fruits | 212 275 |
| Pince à glace | 212 275 316 |
| Pince à glaçon et citron | 212 |
| Pince à homard | 104 |

Index

P Q

| | Pag |
|--------------------------------------|--|
| Pince à hors-d'oeuvres et pâtisserie | 212 275 293 |
| Pince à légumes | 147 212 275 |
| Pince à pain et pâtisserie | 212 |
| Pince à pâtisserie | 212 |
| Pince à rôti | 147 212 275 |
| Pince à servir | 212 |
| Pince à spaghetti | 147 212 275 |
| Pince à sucre | 212 275 293 |
| Pince à sucre et apéritifs | 212 293 |
| Pince à tarte | 212 275 |
| Pince à toast et tarte | 212 275 |
| Pince fonde pour servir | 212 |
| Pince plaine pour servir | 212 |
| Plaque à induction | 208 |
| Plat à escargots | 276 |
| Plat à huîtres | 158 159 161 |
| Plat à oeuf | 144 277 |
| Plat à pain | 149 267 |
| Plat à poisson | 144 270 |
| Plat à présentation | 134 146 149 151 165 186 194 257 263 264 266 283 346 |
| Plat oval | 144 146 270 272 |
| Plat rond | 144 151 206 251 270 272 340 |
| Plateau | 123 133 134 144 150 158 159 161 164 165 175 177 179 180 181 182 185 186 189 192 194 195 202 206 209 215 218 228 229 230 234 235 236 254 257 260 262 263 264 272 273 279 280 288 289 298 |
| Plateau à hors d'oeuvre | 248 258 |
| Plateau à monnaie | 176 301 |
| Plateau avec trousse | 177 |
| Plateau carré | 134 150 158 164 165 185 195 202 229 257 262 |
| Plateau concave | 279 |
| Plateau en fibre de carbone | 122 123 |
| Plateau gn | 185 186 194 215 228 |
| Plateau ovale | 150 159 164 189 218 230 263 273 |
| Plateau porte verres empilable | 235 |
| Plateau pour chariot porte-plateau | 186 235 254 |
| Plateau rond | 159 161 175 177 215 218 229 230 236 257 260 264 |
| Plateau, rectangulaire | 123 133 134 144 150 158 164 185 186 189 192 194 195 202 206 209 215 218 228 229 230 234 235 236 254 257 260 262 263 264 272 273 279 280 288 289 298 |
| Poêle | 323 325 327 331 332 336 |
| Poivrier | 154 |
| Porcelaine | 249 258 |
| Porte brosse à dents | 301 |
| Porte confitures | 225 269 299 |
| Porte craquelins | 178 |
| Porte cure-dents | 185 195 219 225 234 239 268 269 274 280 |
| Porte gobelets | 259 |
| Porte gressin | 151 178 186 193 195 279 |
| Porte macarons | 219 267 288 |
| Porte noyaux | 133 236 |
| Porte petits fours | 216 217 227 266 288 |
| Porte pommes frites | 165 242 278 |
| Porte savon | 299 |
| Porte serviette | 299 |
| Porte-appetizers | 219 287 342 343 |
| Porte-badge | 281 |
| Porte-bouteille | 277 279 |
| Porte-pate/beurre/caviar | 144 225 239 288 |
| Porte-surprises | 170 176 |
| Porte toast | 278 288 |
| Pot à cuillères | 301 |
| Pot à lait | 220 291 292 294 295 296 337 |
| Pot à sucre | 147 154 220 291 292 294 295 296 298 299 |
| Presentoire | 163 221 227 287 288 289 |
| Quarta Posata | 90 <> 93 163 175 |

R S

| | |
|---------------------------|---|
| Râpe | 282 |
| Rafrachisseur à bouteille | 304 |
| Rafrachissoir à yogourt | 210 223 |
| Ravier à parmesan | 133 219 239 259 260 262 263 265 269 276 |
| Rechaud à cafe | 209 |
| Rince doigts | 146 276 |
| Saladier | 146 216 237 249 342 346 |
| Salière | 219 269 |
| Saucière | 144 274 |
| Sauteuse | 246 |
| Seau à champagne | 126 146 152 153 186 222 232 301 302 303 304 305 306 307 308 309 310 314 316 317 342 346 |
| Seau à glace | 146 152 153 222 232 301 302 303 304 305 306 308 314 316 317 346 |
| Seau à glace, thermique | 232 304 305 306 |
| Seau à vin | 126 146 152 153 186 222 232 301 302 303 304 305 306 307 308 309 |

R S

| | |
|---------------------------------------|--|
| Seau à vin | 310 314 316 317 342 346 |
| Service à caviar | 238 |
| Set de table | 134 138 140 185 194 |
| Set pinzimonio | 249 |
| Set pour Amouse bouche | 133 |
| Set pour ceviche | 281 |
| Set salière, poivrier | 154 219 225 239 268 269 274 |
| Shaker | 301 |
| Soliflore | 283 |
| Soupière avec couvercle | 208 224 274 |
| Sous plat | 134 146 149 151 165 186 194 257 263 264 266 283 346 |
| Sous bouteille | 185 186 195 257 264 267 283 |
| Sous verre | 257 264 267 |
| Soutier de sacs | 284 |
| Soutier porte-couverts | 84 102 173 177 195 209 |
| Stands de buffet | 196 197 |
| Street Cover | 138 140 |
| Sucrier | 147 154 220 291 292 294 295 296 298 299 |
| Support | 248 249 |
| Support à tarte | 173 177 216 230 266 |
| Support avec numéro de table | 185 223 237 278 281 |
| Support pour seau à champagne / à vin | 126 128 135 153 222 232 233 302 303 304 305 306 307 309 315 |
| Support pour tacos | 279 |
| Support pour toast | 278 288 |

T V W

| | |
|------------------------------|-----------------------------|
| Tasse | 343 |
| Théière | 220 291 292 294 295 296 |
| Théière thermique | 296 |
| Tiffin box | 252 |
| Tire-bouchon | 282 |
| Tumbler | 178 |
| Vase | 171 176 346 |
| Vase à fleurs | 283 |
| Verre | 154 178 202 206 340 341 346 |
| Verseur de parfum en gouttes | 225 |
| Vinaigre | 219 239 242 268 |
| Vitrine réfrigérée | 358 359 |
| Wok | 333 337 |

Alphabetisches Register

A B C

| | Pag |
|---------------------------|---|
| Aderhalter | 133 236 |
| Ascher | 151 154 276 |
| Ascherständer | 154 |
| Auflaufform auf Porzellan | 249 258 |
| Austernöffner | 160 |
| Badge-Halter | 281 |
| Bargestell | 219 287 342 343 |
| Beilagenschale | 146 276 |
| Beutelstand | 284 |
| Bierbecher | 341 |
| Blumenvase | 283 |
| Bonbonsschale | 170 176 265 |
| Boston Shaker | 301 |
| Bowlenöffel | 301 |
| Bratenplatte | 144 270 |
| Bratentopf | 322 324 326 331 334 |
| Bratpfanne | 323 325 327 331 332 336 |
| Brot Platte | 149 267 |
| Brotkorb | 135 146 149 150 151 186 193 195 218 234 235 237 259 262 265 280 342 |
| Brottschale | 135 146 149 150 151 186 193 195 218 234 235 237 259 262 265 280 342 |
| Buffet Display | 202 |
| Buffetständer | 196 197 |
| Buffet-Tablett | 122 123 134 150 158 159 161 182 185 186 189 192 194 195 202 206 209 215 218 220 223 228 229 230 235 236 254 262 263 264 270 279 280 340 |
| Butterdose | 144 225 239 277 288 |
| Butterkühler | 264 267 |
| Café au Lait-Set | 224 293 |
| Cappuccinolöffel | 104 299 |
| Cevichese | 281 |
| Chafing dish | 208 210 |
| Chafing dish besteck | 209 210 |
| Champagner Bowl | 152 223 233 310 314 315 |
| Champagner Bowlständer | 311 |
| Champagnerflaschenhalter | 211 |
| Champagnerglas | 206 341 |
| Chilimühle | 283 |
| Chillcup | 219 238 |
| Cocktailsieb | 282 |
| Coffee Urn | 209 |
| Cracker Schale | 178 |

DEF

| | |
|--------------------------------------|---|
| Deckel | 224 272 274 |
| Dessertgestell | 221 287 |
| Dressingbehälter | 144 274 |
| Dressinglöffel | 14 <> 72 119 210 274 |
| Eierbecher-Set | 144 277 |
| Eierlöffel | 14 <> 72 |
| Eierpfanne | 147 276 |
| Einsatz Tablett | 133 165 |
| Eis- und Zitronenzange | 212 |
| Eisbecher | 147 180 182 225 237 238 280 288 341 |
| Eisfruchtbecher, Isoliert | 237 280 288 |
| Eisgefäß | 146 152 153 222 232 301 302 303 304 305 306 308 314 316 317 346 |
| Eisgefäß, Isoliert | 232 304 305 306 |
| Eislöffel | 14 <> 72 104 106 299 316 |
| Eisschale | 238 |
| Eisschaufel | 14 <> 72 |
| Eiswasserkrug | 199 291 292 294 |
| Eiswürfel LED | 317 |
| Eiszange | 212 275 316 |
| Essig-/Ölflasche | 219 239 242 268 |
| Essig-/Ölflaschenhalter | 135 262 277 280 |
| Essig-/Ölgestell | 225 239 268 269 |
| Essig-/Öl-Menage | 133 225 239 259 260 262 263 265 268 269 |
| Ess-Stäbchen Paar | 82 |
| Ess-Stäbchen Ablage | 82 |
| Etagère | 158 159 160 177 216 217 223 227 231 266 |
| Feuerschale | 242 244 |
| Fingerfoodzange | 212 |
| Fingerfood-/Vorspeisen-/Butter-Gefäß | 102 133 151 164 165 178 202 206 218 219 236 238 242 264 267 277 278 342 343 |
| Fingerschale | 146 276 |
| Fischplatte | 144 270 |
| Flachzange zum Servieren | 212 |
| Flasche, Isoliert | 368 <> 371 |
| Flaschenhalter | 277 279 |
| Flaschenteller | 185 186 195 257 264 267 283 |
| Fleischgabel | 14 <> 72 104 106 119 209 210 |
| Früchtekorb | 135 146 149 150 151 152 153 155 234 237 262 265 308 309 342 346 |
| Frühstück Tablett | 133 |

G H K

| | Pag |
|-----------------------------|--|
| Gebäckplatte | 144 273 |
| Gebäck- und Servierzange | 212 276 |
| Gemüseseiher | 337 |
| Gemüsetopf | 337 |
| Getränkekühler | 154 209 210 233 291 292 304 315 |
| Gewürzmenage | 269 |
| Gewürzständer | 258 |
| Glas | 154 178 202 206 340 341 346 |
| Glassflasche | 219 239 242 268 |
| Glaskrug | 199 |
| Glasschale | 218 249 |
| Glasuntersatz | 257 264 267 |
| Golf Schleger | 104 316 |
| Gratinplatte | 144 272 273 |
| Griffschale | 129 130 149 |
| Grifftablett | 130 149 |
| Grill Pfanne | 333 |
| Grissini-Halter | 151 178 186 193 195 279 |
| Gueridon | 308 |
| Happy Spoon | 106 |
| Heizelement | 208 |
| Honiglöffel | 98 |
| Hummergabel | 94 104 |
| Hummerzange | 104 |
| Innenteil für Spaghettitopf | 337 |
| Kaffeekanne | 220 291 292 294 295 296 |
| Kaffeekanne, isoliert | 291 292 296 |
| Kaffeespender | 209 |
| Kaffeetablett | 298 |
| Kartenhalter | 223 237 |
| Kartoffenbehälter | 165 242 278 |
| Kartoffellöffel | 14 <> 72 |
| Kasserolle | 322 324 326 331 334 |
| Kaviarkühler | 219 238 |
| Kaviarlöffel | 282 |
| Kaviarschale | 219 238 |
| Korkenheber | 282 |
| Korkenzieher | 282 |
| Kuchen-/Tortenplatte | 218 230 |
| Käsedose | 133 219 239 259 260 262 263 265 269 276 |
| Käsemesser | 14 <> 72 |
| Kohlefaser-Tablett | 122 123 |
| Kühlschale | 158 159 160 161 210 223 |
| Kühlvitrine | 358 359 |

LMN

| | |
|--------------------------|-------------------------|
| Latte Macchiato-Set | 299 |
| Légumier | 146 224 272 274 |
| Leuchter | 221 227 |
| Löffelbecher | 301 |
| Macaronsträger | 219 267 288 |
| Marmeladegestell | 225 269 299 |
| Martini Glass | 278 341 |
| Milchdispenser | 209 |
| Milchkaffee-Set | 224 293 |
| Milchkanne | 220 291 292 294 295 296 |
| Milchkännchen | 154 248 288 299 |
| Milch-Kaffee-Zucker-Set | 224 293 |
| Milchkocher | 337 |
| Mikrogabel | 102 172 176 |
| Mini Bratentopf | 322 324 326 |
| Mini Butterdose | 144 225 239 277 288 |
| Mini Gabel | 102 206 |
| Mini Schale | 177 |
| Mini Spoon | 102 206 |
| Mini Tablett | 164 181 182 183 202 220 |
| Mini Verdampfer | 166 |
| Mokkaétagère | 182 217 227 266 |
| Mug | 343 |
| Multifunktionaler Löffel | 96 163 |
| Nussknacker | 282 |

OPQ

| | |
|----------------------|---|
| Obstschale | 146 150 151 155 158 159 161 189 202 216 218 220 230 237 262 263 265 280 340 343 346 |
| Papierbecherständer | 259 |
| Pâtisserie Tablett | 192 234 235 289 298 |
| Petits Fours-Ständer | 173 177 216 217 220 221 227 266 288 |
| Petits Fours-Tablett | 179 180 181 182 183 |
| Pfeffermühle | 283 |
| Pfefferstreuer | 154 |
| Platten | 144 149 149 193 218 230 235 238 248 258 267 270 272 273 276 299 |
| Platzteller | 134 146 149 151 165 186 194 257 263 264 266 283 346 |
| Portionsschöpfer | 14 <> 72 106 210 301 |
| Porzellanschale | 249 258 |
| Presentoire | 163 221 227 287 288 289 |
| Punchbowl | 223 227 301 |
| Quarta Posata | 90 <> 93 163 175 |

RS

| | |
|-------|-----|
| Reibe | 282 |
|-------|-----|

Alphabetisches Register

| RS | Pag |
|---------------------------------|--|
| Reislöffel | 104 106 119 209 210 |
| Relish-Pickles-Gestell | 219 287 342 343 |
| Rotweinwiege | 277 |
| Saftdispenser | 209 |
| Saftkrug | 199 291 292 294 |
| Sahne-/Zucker-Set | 224 293 |
| Sahnegießer | 154 248 288 299 |
| Sahnekännchen | 147 293 |
| Salat-/Vorlegebesteck | 14 <> 72 106 119 209 210 |
| Salatzange | 147 212 275 |
| Salz- und Pfeffergestell | 154 225 239 268 269 274 |
| Salzmühle | 283 |
| Sauce Set | 280 |
| Saucenlöffel | 14 <> 72 119 210 274 |
| Sauciere | 144 178 |
| Sauteuse | 246 |
| Schale | 125 126 128 129 130 135 146 149 150 151 152 153 155 172 174 176 177 182 186 193 195 202 218 234 235 237 259 262 263 265 280 342 346 |
| Schalenhalter | 248 249 |
| Schmuckablage | 170 176 |
| Schnapsbecher | 341 |
| Schneckengabel | 104 |
| Schneckenzange | 104 275 276 |
| Schneckenplatte | 276 |
| Serviergestell | 221 287 |
| Serviertablett | 123 133 134 144 150 158 159 161 164 165 175 177 179 180 181 182 185 186 189 192 194 195 202 206 209 215 218 228 229 230 234 235 236 254 257 260 262 263 264 272 273 279 280 288 289 298 |
| Servierwagen | 348 <> 363 |
| Serviettenhalter | 192 193 234 258 289 298 |
| Serviettenring | 130 259 |
| Set mit Porzellanschale | 258 |
| Shot Glass | 154 |
| Snackschale | 277 |
| Sorbetschale | 100 278 |
| Spaghettitopf | 337 |
| Speckstein | 242 |
| Speisekartenhalter | 223 237 |
| Stand für Plastik Platte | 259 |
| Stapelbare Gläserträger Tablett | 235 |
| Steakmessern | 14 <> 72 86 88 243 |
| Stielkasserolle | 322 324 326 331 334 |
| Suppenmarmite | 208 |
| Suppenschöpfer | 14 <> 72 106 301 |
| Suppenstation | 208 |
| Suppentasse | 274 |
| Suppenterrine | 224 274 |
| Street Cover | 138 140 |
| Strohalm Halter | 316 |

| T | |
|-----------------------------|--|
| Tablett | 123 133 134 144 150 158 159 161 164 165 175 177 179 180 181 182 185 186 189 192 194 195 202 206 209 215 218 228 229 230 234 235 236 254 257 260 262 263 264 272 273 279 280 288 289 298 |
| Tablett Gastronorm | 185 186 194 215 228 |
| Tablett für Rack | 186 235 254 |
| Tablett für Stoffservietten | 299 |
| Tablett, konkave | 279 |
| Tablett, oval | 150 159 164 189 218 230 263 273 |
| Tablett, quadratisch | 134 150 158 164 165 185 195 202 229 257 262 |
| Tablett, rechteckig | 123 133 134 144 150 158 164 185 186 189 192 194 195 202 206 209 215 218 228 229 230 234 235 236 254 257 260 262 263 264 272 273 279 280 288 289 298 |
| Tablett, rund | 159 161 175 177 215 218 229 230 236 257 260 264 |
| Tacoshalter | 279 |
| Tafelaufsatz | 155 158 159 161 189 202 |
| Teeglas | 202 |
| Teekanne | 220 291 292 294 295 296 |
| Teekanne, Isoliert | 296 |
| Teller | 146 251 272 |
| Teller cloche | 221 223 224 236 251 273 276 281 |
| Thermische Ringröhre | 249 251 |
| Tiefzange zum Servieren | 212 |
| Tiffin box | 252 |
| Tischnummer | 185 223 237 278 281 |
| Tischnummernständer | 185 223 237 278 281 |
| Tischnummern-Aufsteller | 223 237 281 |
| Tischrestebehälter | 151 176 301 |
| Tischset | 134 140 185 194 |
| Toastständer | 278 288 |
| Tortenheber | 14 <> 72 106 118 209 210 |
| Tranchiergabel | 14 <> 72 104 106 119 209 210 |
| Tranchiermesser | 14 <> 72 86 88 243 |

| T | Pag |
|----------------------------|---|
| Tropf-Parfüm Aussteller | 225 |
| Trüffel Hobel | 283 |
| Tumbler | 178 |
| U V W | |
| Universalschale | 146 216 237 342 343 346 |
| Universalschale auf Holz | 277 |
| Universalträger | 170 176 |
| Vorspeisenplatte | 248 258 |
| Vorspeisen Set | 133 |
| Yogurtkühler | 210 223 |
| Warmhalteteller | 251 |
| Wasserascher | 151 |
| Weinbecher | 206 340 341 |
| Wein-/Sekt Kühler | 126 146 152 153 186 222 232 301 302 303 304 305 306 307 308 309 310 314 316 317 342 346 |
| Weinkühler | 304 305 |
| Weinkühlerständer | 126 128 135 153 222 232 233 302 303 304 305 306 307 309 315 |
| Whisky Becher | 341 |
| Wokpfanne | 333 337 |
| Z | |
| Zahlsteller | 151 |
| Zahnstocherbehälter | 185 195 219 225 234 239 268 269 274 280 |
| Zucker- und Cocktailszange | 212 293 |
| Zuckerdose | 147 154 220 291 292 294 295 296 298 299 |
| Zuckergestell | 224 225 287 293 |
| Zuckerständer | 267 |
| Zuckerstangengefäß | 193 220 234 289 296 298 299 |
| Zuckerzange | 212 275 293 |

Indice

| A B | Pág. |
|------------------------------------|---|
| Abrebotellas | 282 |
| Accesorios | 82 <> 107 |
| Aceitera | 219 239 242 268 |
| Apoyo para bolsas | 284 |
| Apoyo para chopsticks | 82 |
| Apoyo para cubiertos | 84 102 173 177 195 209 |
| Azucarera | 193 220 234 289 296 298 299 |
| Azucarero | 147 154 220 291 292 294 295 296 298 299 |
| Bac rond | 258 |
| Bajo plato | 134 146 149 151 165 186 194 257 263 264 266 283 346 |
| Bandeja | 123 133 134 144 150 158 159 161 164 165 175 177 179 180 181 182 185 186 189 192 194 195 202 206 209 215 218 228 229 230 234 235 236 236 254 257 260 262 263 264 272 273 279 280 288 289 298 |
| Bandeja con agujeros | 177 |
| Bandeja concavo | 279 |
| Bandeja cuadrada | 134 150 158 164 165 185 195 202 229 257 262 |
| Bandeja cuentas y propinas | 176 301 |
| Bandeja de fibra de carbono | 122 123 |
| Bandeja gn | 185 186 194 215 228 |
| Bandeja para estantes | 186 235 254 |
| Bandeja portaservilletas | 299 |
| Bandeja portavasos impilable | 235 |
| Bandeja rectangular | 123 133 134 144 150 158 164 185 186 189 192 194 195 202 206 209 215 218 228 229 230 234 235 236 254 257 260 262 263 264 272 273 279 280 288 289 298 |
| Bandeja redonda | 159 161 175 177 215 218 229 230 236 257 260 264 |
| Bandeja tartas | 218 230 |
| Baterias de cocina & accesorios | 330 |
| Bistequera | 333 |
| Bobina térmica | 249 251 |
| Bol à salade de fruits | 146 216 237 309 342 346 |
| Bol para caviar | 219 238 |
| Bol para limpiar dedos | 146 276 |
| Botella | 242 |
| Botella térmica | 368 <> 371 |
| C | |
| Cacerola | 322 324 326 331 334 |
| Cafetera | 220 291 292 294 295 296 |
| Cafetera térmica | 291 292 296 |
| Calentador de café | 209 |
| Calientador à inducción | 208 |
| Calientador eléctrico | 208 |
| Candelabro | 221 227 |
| Carros | 348 <> 362 |
| Cascanueces | 282 |
| Cazo | 14 <> 72 106 301 |
| Cenicero | 151 154 276 |
| Cenicero a columna | 154 |
| Centro mesa | 155 158 159 161 189 202 |
| Cesta | 125 126 128 129 130 135 146 149 150 151 152 153 155 172 174 176 177 182 186 193 195 202 218 234 235 237 259 262 263 265 280 342 346 |
| Cesta pan | 135 146 149 150 151 186 193 195 218 234 235 237 259 262 265 280 342 |
| Cesta para fruta | 135 146 149 150 151 152 153 155 234 237 262 265 308 309 342 346 |
| Cesto por aromaticos y condimentos | 135 262 277 280 |
| Cevichera | 281 |
| Chafing-dish | 208 210 |
| Chop sticks | 82 |
| Coctelera | 301 |
| Coctelera con vaso | 301 |
| Colador para cóctel | 282 |
| Colador para olla pastas | 337 |
| Columna porta cesta champany | 311 |
| Columna porta cubo champany | 126 128 135 153 222 232 233 302 303 304 305 306 307 309 315 |
| Contenedor para café | 199 209 |
| Contenedor para zumo de fruta | 199 209 |
| Contenedor sobres té | 193 220 234 289 296 298 299 |
| Copa caviar | 219 238 |
| Copa cóctel camarones | 219 238 |
| Copa con base | 146 147 216 218 223 237 301 |
| Copa de vidrio | 218 |
| Copa gazpacho/potage | 274 |
| Copa helado y macedonia | 147 180 182 225 237 238 280 288 341 |
| Copa mantequilla | 219 238 |
| Copa para intermezzo | 100 278 |
| Copa salsa | 144 178 274 |
| Copa soufflé | 144 178 274 |
| Copa térmica | 237 280 288 |
| Copa universal | 102 178 0 |

| C | Pág. |
|-------------------------------|---|
| Copa vichyssoise | 219 238 274 |
| Copita | 102 178 180 182 225 |
| Cortador de trufas | 283 |
| Cuberteria | 14 <> 72 86 88 96 98 102 104 106 118 119 160 163 176 206 209 210 243 274 282 299 301 |
| Cubitera de champaña | 152 223 233 310 314 315 |
| Cubitera hielo | 146 152 153 222 232 301 302 303 304 305 306 308 314 316 317 346 |
| Cubitera hielo térmica | 232 304 305 306 |
| Cubito hielo LED | 317 |
| Cubo de champagne gigante | 310 |
| Cubo vino | 126 146 152 153 186 222 232 301 302 303 304 305 306 307 308 309 310 314 316 317 342 346 |
| Cubreplatos ovales | 272 273 |
| Cubreplatos, redondo | 251 270 273 |
| Cuchara arroz | 104 106 119 209 210 |
| Cuchara cocktail | 14 <> 72 102 206 |
| Cuchara de miel | 98 |
| Cuchara ensalada | 14 <> 72 106 119 209 210 |
| Cuchara multifuncional | 96 163 |
| Cuchara parmesán | 14 <> 72 |
| Cuchara servir | 14 <> 72 104 106 119 209 210 |
| Cucharita cappuccino | 104 299 |
| Cucharita caviar | 282 |
| Cucharita mezcladora | 14 <> 72 104 106 299 316 |
| Cucharita para sal | 102 206 |
| Cuchillo ostras | 160 |
| Cuchillo servir pescado | 14 <> 72 102 115 |
| Cuchillos | 14 <> 72 86 88 104 118 160 243 |
| Cúpula cobre-plateos | 221 223 224 236 251 273 276 281 |
| Cuenco | 146 149 150 151 177 178 182 202 216 218 225 235 237 259 277 309 340 342 343 346 |
| Cuenco con bandeja | 178 2 182 225 |
| Cuenco con pedestal | 146 216 237 |
| Cúpula refrigerada | 358 359 |
| D E F | |
| Dispensador | 209 |
| Dosador sal/pimienta | 154 |
| Ensaladera | 146 216 237 249 342 346 |
| Entremesera | 248 258 |
| Escurridera | 337 |
| Finger Food | 102 106 133 162 <> 167 172 176 185 195 202 206 212 |
| Florero | 283 |
| Frutero | 155 158 159 161 189 |
| Fuente de marisco | 144 161 270 |
| Fuente oval | 144 146 270 272 |
| Fuente para Lasagne | 249 258 |
| Fuente pescado | 144 270 |
| G H I J L | |
| Golf club cucharita coctél | 104 316 |
| Gueridon | 308 |
| Hoguera con piedras naturales | 242 244 |
| Huevera | 144 277 |
| Individual en acero | 185 194 |
| Individual en madera | 134 |
| Individual en goma | 138 <> 141 |
| Inserto por finger food | 133 165 |
| Jarra | 147 |
| Jarra agua | 199 |
| Jarra leche | 220 291 292 294 295 296 |
| Jarra térmica | 291 292 |
| Jarrita lechera | 154 248 288 299 |
| Joyerero | 170 176 |
| Juego azucar | 225 267 287 293 |
| Juego café au lait | 293 299 |
| Juego leche, café y azucar | 293 299 |
| Lavadodos | 146 276 |
| Legumbreira | 224 274 |
| Legumbreira escoffier | 274 |
| M N O | |
| Mantèl individual | 134 138 <> 140 185 194 |
| Mantequillera | 277 299 |
| Marmeladero | 225 269 299 |
| Medida bar, doble | 301 |
| Micro tenedor | 102 172 176 |
| Mini bandeja | 164 181 182 183 202 220 |
| Mini cacerola | 322 324 326 |
| Mini cuenco | 177 |
| Mini spoon | 102 206 |
| Mini tenedor | 102 206 |
| Mini vaporizador | 166 |
| Molinillo chile | 283 |
| Molinillo hierbas | 283 |
| Molinillo pimienta | 283 |
| Molinillo sal | 283 |
| Mug | 343 |
| Número de mesa | 185 223 237 278 281 |
| Olla para pastas | 337 |

Indice

| P Q | Pág. |
|--------------------------------|---------------------------------|
| Pala para tarta | 14 <> 72 106 118 209 210 |
| Pala pescado | 14 <> 72 106 119 |
| Palillero | 185 195 219 225 234 239 268 |
| | 269 274 280 |
| Panera | 135 151 186 193 195 218 234 235 |
| | 259 265 280 342 |
| Pedestal para tarta | 173 177 216 217 220 221 227 266 |
| | 288 |
| Petit marmite | 208 |
| Pimentero | 154 225 239 268 269 274 |
| Pinzas asados y verduras | 147 212 275 |
| Pinzas azucar | 212 275 293 |
| Pinzas azucar y aperitivos | 212 293 |
| Pinzas caracoles | 104 275 276 |
| Pinzas entremeses y pasteles | 212 275 |
| Pinzas espagueti | 147 212 275 |
| Pinzas espárragos | 147 212 275 |
| Pinzas frutas | 212 275 |
| Pinzas fundas para servir | 212 |
| Pinzas hielo | 212 275 316 |
| Pinzas hielo y limón | 212 |
| Pinzas llanas para servir | 212 |
| Pinzas pan y pasteles | 212 |
| Pinzas pasteles | 212 275 |
| Pinzas pasteles y tostadas | 212 275 |
| Pinzas por finger food | 212 |
| Pinzas servir | 212 |
| Pinzas verduras | 147 212 275 |
| Pinzimonio | 249 |
| Pizarra | 242 |
| Plancha refrigerada | 358 359 |
| Platillo para mantequilla | 264 267 |
| Platito bajo botellas | 185 186 195 257 264 267 283 |
| Platito bajo vasos | 257 264 267 |
| Plato caracoles | 276 |
| Plato concavo | 193 235 |
| Plato de presentación | 134 146 149 151 165 186 194 257 |
| | 263 264 266 283 346 |
| Plato huevos | 147 276 |
| Plato ostras | 158 159 161 |
| Plato para pan | 149 267 |
| Plato térmico | 251 |
| Ponchera | 223 227 301 |
| Porcelana | 249 258 |
| Porta bastoncillos de pan | 151 178 186 193 195 279 |
| Porta botellas | 277 279 |
| Porta cepillo de dientes | 301 |
| Porta cucharitas | 301 |
| Porta dulces | 216 217 227 266 288 |
| Porta galletas saladas | 178 |
| Porta granos | 133 236 |
| Porta jabón | 299 |
| Porta informaciones | 223 237 |
| Porta macaron | 219 267 288 |
| Porta numero de mesa | 185 223 237 278 281 |
| Porta paliillas | 185 195 219 225 234 239 268 |
| | 269 274 280 |
| Porta patatas fritas | 165 242 278 |
| Porta pescado | 158 159 160 223 231 |
| Porta servilletas | 192 193 234 258 289 298 |
| Porta sorpresas | 170 176 |
| Porta Tacos | 279 |
| Porta tarjeta | 281 |
| Porta tostadas | 278 288 |
| Porta vasos | 259 |
| Portapan | 151 178 185 186 193 195 279 |
| Portaplatos de plastica | 259 |
| Posabotella | 185 186 195 257 264 267 283 |
| Posavaso | 257 264 267 |
| Posavaso por mug | 343 |
| Pote leche | 337 |
| Presentoire | 163 221 227 287 288 289 |
| Puerto paté/mantequilla/caviar | 225 269 299 |
| Quarta Posata | 90 <> 93 163 175 |
| Quesera | 133 219 239 259 260 262 263 265 |
| | 269 276 |

R S

| | |
|---------------------------------------|-------------------------|
| Rallador | 282 |
| Refrigerador para yogurt | 210 223 |
| Rompenueces | 282 |
| Salero y pimentero | 154 225 239 268 269 274 |
| Salsera | 144 274 |
| Saucière | 144 178 |
| Sauteuse | 246 |
| Servicio para aperitivos | 133 |
| Servicio para buffet | 202 206 |
| Servicio para café con leche | 224 293 |
| Servicio para caviar | 238 |
| Servicio para champagne | 305 |
| Servicio para ensaladas | 249 |
| Servicio para Lasagne | 249 258 |
| Servicio para salsa | 280 |
| Servicio por aromaticos y condimentos | 135 262 277 280 |
| Servicio por entremes | 219 |
| Servilletero | 130 259 |

R S

| R S | Pág. |
|--------------------|-------------|
| Sopera | 208 224 274 |
| Soportes de buffet | 196 197 |
| Soporte platos | 221 287 |
| Soporte multi usos | 248 249 |
| Street cover | 138 140 |

T V W

| | |
|------------------------------|---------------------------------|
| Tapa | 224 272 274 |
| Tapa legumbrera y sopera | 224 274 |
| Tarjetas | 185 223 237 278 281 |
| Tazas | 343 |
| Tenedor caracoles | 104 |
| Tenedor cocktail | 102 172 176 206 |
| Tenedor diápasón | 104 |
| Tenedor ensalada | 14 <> 72 106 119 209 210 |
| Tenedor langostas | 94 104 |
| Tenedor ostras | 14 <> 72 |
| Tenedor pescado | 14 <> 72 106 119 |
| Tenedor servir | 14 <> 72 104 106 119 209 210 |
| Tetera | 220 291 292 294 295 296 |
| Tetera térmica | 296 |
| Tiffin box | 252 |
| Tumbler | 178 |
| Vaso | 154 178 202 206 340 341 346 |
| Versador de perfume en gotas | 225 |
| Vinagrera | 219 239 242 268 |
| Vinagreras con saleros | 133 225 239 259 260 262 263 265 |
| | 268 269 |
| Wok | 333 337 |

Index

| Pag | | Pag | | Pag | | Pag | | Pag | | Pag | |
|------------|-----|------------|-----|------------|-----|------------|-----|------------|-----|------------|-----|
| 025 | 282 | 260 | 176 | 418 | 185 | 548 | 301 | 666C | 153 | 729 | 301 |
| 03180 | 349 | 260 | 242 | 418 | 194 | 549 | 164 | 666C | 309 | 730 | 152 |
| 03280 | 349 | 262G | 159 | 419 | 186 | 549 | 202 | 666CMG | 128 | 730 | 314 |
| 03680 | 349 | 262 | 159 | 419 | 194 | 550 | 343 | 666E | 232 | 737 | 182 |
| 03780 | 349 | 264 | 280 | 420 | 185 | 551 | 301 | 666E | 306 | 737 | 183 |
| 041104 | 353 | 270 | 192 | 420 | 194 | 552 | 343 | 666F | 222 | 738 | 178 |
| 042104 | 353 | 270 | 234 | 421 | 102 | 553 | 340 | 666F | 302 | 739 | 177 |
| 046104 | 353 | 272A | 251 | 422 | 185 | 554 | 340 | 666H | 303 | 740 | 102 |
| 047 | 282 | 272B | 251 | 422 | 195 | 555N | 206 | 666HMG | 128 | 740 | 178 |
| 047104 | 353 | 272C | 251 | 423 | 102 | 555 | 340 | 666I | 233 | 742 | 179 |
| 048 | 282 | 273A | 251 | 423 | 185 | 557 | 150 | 666I | 315 | 742 | 181 |
| 049 | 282 | 273B | 251 | 423 | 195 | 557 | 189 | 666K | 311 | 742 | 182 |
| 051104 | 352 | 280 | 281 | 424 | 102 | 558 | 150 | 666L | 307 | 743 | 176 |
| 052104 | 352 | 281 | 281 | 424 | 234 | 558G | 159 | 666M | 307 | 744 | 172 |
| 056104 | 352 | 289 | 165 | 425 | 252 | 558V | 159 | 666MG | 126 | 744 | 176 |
| 057104 | 352 | 289 | 242 | 426 | 185 | 559 | 151 | 666W | 308 | 744 | 193 |
| 09150 | 349 | 289 | 242 | 427 | 186 | 561 | 150 | 666Z | 308 | 745 | 179 |
| 09250 | 349 | 289 | 278 | 427 | 195 | 561 | 189 | 668MG | 126 | 745 | 180 |
| 094 | 280 | 292 | 267 | 428 | 186 | 562 | 150 | 668 | 232 | 745 | 181 |
| 098 | 280 | 293 | 266 | 428 | 194 | 562G | 158 | 668 | 306 | 745 | 182 |
| 09841 | 280 | 301 | 238 | 429 | 186 | 562V | 158 | 669 | 232 | 746 | 181 |
| 099 | 346 | 301A | 238 | 430 | 186 | 567 | 151 | 669 | 306 | 746 | 182 |
| 105 | 267 | 301C | 238 | 430 | 307 | 568 | 151 | 669MG | 126 | 746 | 183 |
| 106 | 267 | 301B | 238 | 438 | 152 | 569 | 151 | 670 | 298 | 747 | 180 |
| 133 | 283 | 304 | 269 | 438 | 317 | 570 | 154 | 671 | 283 | 747 | 182 |
| 140 | 229 | 306 | 259 | 439 | 152 | 570 | 248 | 672 | 305 | 748 | 170 |
| 140K | 229 | 307 | 259 | 439 | 317 | 571 | 154 | 674 | 233 | 748 | 176 |
| 141GN | 228 | 308 | 259 | 446 | 278 | 574 | 248 | 674 | 315 | 749 | 172 |
| 144GN | 228 | 309 | 268 | 447N | 283 | 575 | 248 | 675 | 279 | 749 | 176 |
| 144GN2 | 228 | 310 | 259 | 451 | 278 | 576 | 249 | 675P | 279 | 750 | 102 |
| 146GN | 228 | 312 | 268 | 451 | 288 | 579 | 249 | 676 | 304 | 750 | 172 |
| 151 | 209 | 313 | 257 | 462N | 283 | 580 | 249 | 678 | 305 | 750 | 176 |
| 152 | 279 | 315 | 257 | 464N | 283 | 581 | 248 | 679 | 305 | 751 | 276 |
| 154 | 235 | 316 | 257 | 466N | 283 | 582 | 248 | 680 | 305 | 752 | 276 |
| 155 | 133 | 317 | 259 | 473N | 282 | 582 | 249 | 681 | 305 | 753 | 173 |
| 155 | 236 | 319 | 257 | 485 | 160 | 583 | 249 | 682 | 199 | 753 | 177 |
| 156 | 278 | 320 | 257 | 496AC | 279 | 588P | 206 | 683 | 316 | 754 | 175 |
| 163 | 133 | 321 | 259 | 497 | 268 | 588 | 340 | 684 | 316 | 754 | 177 |
| 168 | 260 | 323 | 257 | 498 | 239 | 590 | 343 | 685 | 233 | 755 | 284 |
| 169 | 260 | 324 | 268 | 499 | 299 | 591P | 206 | 685 | 315 | 756 | 284 |
| 170 | 146 | 325 | 268 | 500 | 177 | 591 | 340 | 686 | 233 | 757 | 284 |
| 171 | 146 | 331 | 263 | 501 | 177 | 592 | 343 | 686 | 315 | 758 | 284 |
| 175 | 146 | 332 | 263 | 502 | 265 | 593 | 343 | 688 | 152 | 760 | 212 |
| 176 | 146 | 333 | 263 | 503 | 277 | 594 | 248 | 688 | 317 | 761 | 212 |
| 178 | 144 | 335 | 263 | 504 | 277 | 594 | 299 | 689 | 152 | 762 | 212 |
| 179 | 147 | 336 | 263 | 505 | 235 | 595 | 299 | 689 | 317 | 763 | 212 |
| 180 | 147 | 337 | 263 | 505 | 262 | 596 | 152 | 691 | 199 | 765 | 212 |
| 184 | 144 | 350 | 268 | 506 | 239 | 596 | 309 | 693 | 370 | 766 | 212 |
| 186 | 144 | 355 | 277 | 507 | 239 | 597 | 153 | 700 | 165 | 767 | 212 |
| 187 | 144 | 356 | 277 | 508 | 268 | 597 | 308 | 700 | 242 | 768 | 212 |
| 188 | 147 | 356 | 280 | 509 | 268 | 598 | 153 | 700 | 298 | 769 | 212 |
| 204 | 267 | 364A | 296 | 510 | 268 | 598 | 308 | 702 | 239 | 769 | 293 |
| 205 | 192 | 364B | 296 | 510 | 268 | 598 | 310 | 702 | 288 | 771 | 275 |
| 205 | 235 | 364T | 296 | 510ST | 268 | 599 | 135 | 703AC | 171 | 772 | 275 |
| 205 | 289 | 370 | 303 | 511 | 274 | 599 | 152 | 703AC | 176 | 774 | 275 |
| 206 | 192 | 371 | 303 | 511 | 274 | 599 | 309 | 703 | 299 | 775 | 275 |
| 206 | 235 | 380 | 316 | 512 | 269 | 599 | 309 | 704 | 193 | 777 | 275 |
| 206 | 289 | 381 | 316 | 512 | 269 | 599 | 342 | 704 | 234 | 778 | 275 |
| 206 | 298 | 382 | 196 | 513 | 239 | 601 | 269 | 704 | 289 | 779 | 104 |
| 208 | 267 | 382 | 275 | 513 | 239 | 602 | 269 | 704 | 298 | 779 | 275 |
| 209 | 264 | 382 | 316 | 514P | 154 | 603 | 269 | 706 | 299 | 779 | 276 |
| 210 | 264 | 383 | 196 | 514S | 154 | 604 | 269 | 707 | 277 | 787 | 133 |
| 212A | 189 | 384 | 197 | 516 | 193 | 605 | 342 | 708 | 301 | 789 | 134 |
| 212 | 189 | 385 | 197 | 516 | 234 | 606 | 343 | 709 | 281 | 789 | 134 |
| 220 | 227 | 386 | 197 | 516 | 289 | 607 | 153 | 711 | 277 | 791 | 134 |
| 222A | 189 | 387 | 196 | 516 | 298 | 608 | 152 | 712 | 238 | 791 | 134 |
| 222 | 189 | 388 | 197 | 518 | 234 | 609 | 149 | 713 | 238 | 791 | 165 |
| 225 | 358 | 389 | 197 | 520 | 164 | 611 | 269 | 714 | 238 | 791 | 165 |
| 225 | 359 | 390 | 196 | 522 | 265 | 612 | 149 | 715 | 267 | 791AC | 133 |
| 229 | 280 | 391 | 196 | 523 | 177 | 616AC | 149 | 716 | 264 | 791AC | 165 |
| 230 | 280 | 403 | 185 | 525 | 239 | 617 | 149 | 717 | 178 | 791E | 164 |
| 232 | 279 | 403 | 194 | 526 | 288 | 620 | 242 | 718 | 178 | 793 | 133 |
| 235G | 161 | 404 | 185 | 527 | 341 | 639 | 293 | 719 | 154 | 794 | 133 |
| 235 | 161 | 404 | 195 | 528 | 276 | 649 | 293 | 720 | 299 | 795 | 134 |
| 236 | 210 | 404 | 195 | 531 | 341 | 657 | 223 | 721 | 237 | 796 | 134 |
| 242 | 155 | 406 | 262 | 533 | 341 | 658 | 317 | 721 | 288 | 799N | 277 |
| 242G | 160 | 407 | 262 | 534 | 341 | 660 | 305 | 722 | 238 | 799P | 277 |
| 24222G | 160 | 408 | 262 | 535 | 341 | 661 | 301 | 723 | 238 | 799W | 277 |
| 252 | 158 | 409 | 262 | 536 | 341 | 662 | 304 | 725 | 238 | 804 | 135 |
| 252G | 158 | 410 | 262 | 543N | 206 | 663 | 304 | 727 | 100 | 844 | 265 |
| 254 | 237 | 411 | 262 | 543 | 341 | 664 | 304 | 727B | 100 | 870 | 151 |
| 258 | 227 | 415 | 236 | 544 | 277 | 665 | 301 | 727N | 100 | 870 | 151 |
| 258 | 288 | 416 | 185 | 545 | 301 | 666 | 304 | 727O | 100 | 870 | 193 |
| 260 | 165 | 416 | 195 | 546 | 301 | 666A | 305 | 727OI | 100 | 871 | 155 |
| 260 | 171 | 417 | 186 | 547 | 301 | 666B | 135 | 727 | 278 | 871 | 193 |

Index

| Pag | | Pag | | Pag | | Pag | | Pag | | Pag | |
|-------|-----|--------|-----|-------|-----|--------|-----|--------|-----|--------|-----|
| 872 | 178 | 976C | 219 | 7002B | 231 | 16450 | 260 | 24722 | 221 | 28232 | 242 |
| 874 | 146 | 976S | 219 | 7003A | 266 | 16535 | 260 | 24722 | 273 | 28232 | 244 |
| 878 | 147 | 976C | 287 | 7003B | 266 | 17230 | 144 | 24724 | 221 | 28327 | 236 |
| 879 | 147 | 976S | 287 | 7004A | 231 | 17240 | 144 | 24724 | 273 | 28335 | 236 |
| 880 | 146 | 978 | 217 | 7004B | 231 | 17250 | 144 | 24726 | 221 | 28340 | 236 |
| 881 | 147 | 980B | 217 | 7011 | 202 | 17355 | 144 | 24726 | 273 | 28430 | 236 |
| 882 | 146 | 980A | 217 | 7011E | 202 | 17370 | 144 | 24728 | 221 | 28435 | 236 |
| 883 | 337 | 981A | 216 | 7012 | 206 | 17427 | 144 | 24728 | 273 | 28440 | 236 |
| 884 | 146 | 981B | 216 | 7070 | 227 | 17435 | 144 | 24730 | 221 | 28445 | 236 |
| 886 | 346 | 982 | 218 | 7071 | 227 | 17440 | 144 | 24730 | 273 | 28450 | 236 |
| 888 | 346 | 982 | 220 | 7072 | 227 | 17726 | 144 | 24731 | 221 | 28460 | 236 |
| 891 | 346 | 983 | 223 | 7073 | 227 | 17731 | 144 | 24731 | 273 | 28730 | 230 |
| 892 | 346 | 984 | 221 | 7086 | 210 | 18130 | 144 | 24732 | 221 | 28740 | 230 |
| 899 | 153 | 984 | 287 | 7087 | 210 | 18140 | 144 | 24732 | 273 | 28750 | 230 |
| 899 | 314 | 985 | 221 | 7090 | 210 | 18235 | 144 | 24733 | 221 | 28760 | 230 |
| 901 | 278 | 985 | 287 | 7092 | 221 | 18240 | 144 | 24733 | 273 | 28830 | 230 |
| 902 | 165 | 986 | 223 | 7093 | 221 | 18514 | 146 | 25035 | 229 | 28840 | 230 |
| 902 | 242 | 987 | 223 | 7094 | 221 | 18520 | 146 | 25040 | 229 | 28850 | 230 |
| 902 | 298 | 988 | 225 | 7199 | 208 | 18524 | 146 | 25127 | 270 | 28860 | 230 |
| 903 | 278 | 989 | 221 | 7199A | 208 | 19931 | 264 | 25130 | 270 | 29419 | 266 |
| 904 | 276 | 989 | 287 | 7199B | 208 | 20130 | 264 | 25135 | 270 | 29424 | 266 |
| 905 | 279 | 990 | 180 | 7199C | 208 | 20140 | 264 | 25140 | 270 | 29535 | 230 |
| 905P | 279 | 990 | 182 | 7201 | 208 | 20150 | 264 | 25327 | 273 | 29645 | 230 |
| 906 | 82 | 990 | 225 | 7201A | 208 | 20240 | 264 | 25335 | 223 | 29745 | 230 |
| 906 | 84 | 994A | 237 | 7201B | 208 | 20250 | 264 | 25335 | 273 | 29840 | 230 |
| 907 | 237 | 994B | 237 | 7201C | 208 | 20325 | 264 | 25340 | 273 | 30280 | 360 |
| 909 | 153 | 994C | 281 | 7206 | 209 | 20331 | 264 | 25506 | 163 | 30538 | 257 |
| 909 | 314 | 995A | 223 | 7208 | 209 | 20560 | 192 | 25506 | 288 | 30545 | 257 |
| 910 | 153 | 995B | 223 | 10192 | 354 | 20560 | 235 | 25508 | 163 | 30980 | 360 |
| 910 | 314 | 996 | 278 | 10292 | 354 | 20560 | 289 | 25508 | 288 | 31440 | 279 |
| 911 | 276 | 998 | 277 | 10333 | 266 | 20660 | 192 | 25514 | 227 | 31455 | 279 |
| 912 | 153 | 999C | 154 | 10335 | 266 | 20660 | 235 | 25514 | 289 | 31802 | 268 |
| 912 | 314 | 1001 | 130 | 10432 | 283 | 20660 | 289 | 25520 | 227 | 32250 | 362 |
| 913 | 281 | 1003 | 130 | 10692 | 354 | 20660 | 298 | 25520 | 289 | 32950 | 362 |
| 914 | 182 | 1004 | 130 | 10792 | 354 | 20724 | 234 | 25524 | 227 | 33298 | 361 |
| 914 | 183 | 1005 | 130 | 12150 | 350 | 20730 | 234 | 25524 | 289 | 33998 | 361 |
| 914 | 220 | 1006 | 130 | 12250 | 350 | 20734 | 234 | 25627 | 229 | 36101 | 296 |
| 915 | 84 | 1009 | 129 | 12650 | 350 | 21126 | 273 | 25635 | 229 | 36104 | 296 |
| 916 | 178 | 1010 | 129 | 12750 | 350 | 21131 | 273 | 25640 | 229 | 36106 | 296 |
| 918 | 178 | 1011 | 128 | 13132 | 266 | 22512 | 236 | 25714 | 227 | 36108 | 296 |
| 919 | 174 | 1012 | 128 | 13626 | 298 | 22512 | 281 | 25714 | 288 | 36110 | 296 |
| 919 | 177 | 1013 | 128 | 13760 | 229 | 22522 | 236 | 25720 | 227 | 36116 | 296 |
| 920 | 102 | 1014 | 128 | 13860 | 229 | 22522 | 281 | 25720 | 288 | 36202 | 296 |
| 920 | 173 | 1016 | 125 | 13960 | 229 | 22528 | 236 | 25728 | 227 | 36204 | 296 |
| 920 | 177 | 1017 | 125 | 14130 | 228 | 22528 | 281 | 25728 | 288 | 36206 | 296 |
| 922 | 225 | 1581 | 337 | 14135 | 228 | 23125 | 270 | 25920 | 237 | 36208 | 296 |
| 935 | 219 | 1591 | 337 | 14140 | 228 | 23130 | 270 | 25928 | 237 | 36301 | 296 |
| 935 | 288 | 2180 | 333 | 14145 | 228 | 23135 | 270 | 26202 | 155 | 36304 | 296 |
| 937 | 218 | 3100J | 141 | 14150 | 228 | 23140 | 270 | 26202G | 160 | 36306 | 296 |
| 938 | 218 | 3100S7 | 141 | 14160 | 228 | 23145 | 270 | 26203 | 155 | 36308 | 296 |
| 939 | 224 | 3101H7 | 141 | 14180 | 228 | 23150 | 270 | 26203G | 160 | 36316 | 296 |
| 939 | 293 | 3101Q7 | 141 | 14190 | 359 | 23160 | 270 | 26204 | 155 | 36606 | 296 |
| 940 | 224 | 3102F7 | 141 | 14270 | 123 | 23330 | 270 | 26204G | 160 | 36608 | 296 |
| 940 | 293 | 3102N7 | 141 | 14290 | 359 | 23335 | 270 | 26303 | 272 | 36704 | 296 |
| 940E | 224 | 3200J | 141 | 14440 | 228 | 23340 | 270 | 26403 | 272 | 36706 | 296 |
| 940E | 293 | 3200S7 | 141 | 14445 | 228 | 23345 | 270 | 26524 | 192 | 42945 | 254 |
| 941 | 301 | 3201H7 | 141 | 14450 | 228 | 23350 | 270 | 26524 | 234 | 42963 | 254 |
| 941 | 316 | 3201Q7 | 141 | 14460 | 228 | 23535 | 272 | 26524 | 289 | 51610 | 234 |
| 942 | 225 | 3202F7 | 141 | 14480 | 228 | 23540 | 272 | 26530 | 192 | 51610 | 289 |
| 943 | 225 | 3202N7 | 141 | 14630 | 228 | 23635 | 272 | 26530 | 234 | 51710 | 346 |
| 943 | 225 | 3300J | 141 | 14635 | 228 | 23640 | 272 | 26530 | 289 | 51722 | 346 |
| 947 | 225 | 3300S7 | 141 | 14640 | 228 | 23825 | 273 | 26534 | 192 | 51728 | 346 |
| 948 | 307 | 3301H7 | 141 | 14645 | 228 | 23830 | 273 | 26534 | 234 | 51755 | 346 |
| 949 | 223 | 3301Q7 | 141 | 14650 | 228 | 23835 | 273 | 26534 | 289 | 52405 | 288 |
| 956 | 276 | 3302F7 | 141 | 14660 | 228 | 23840 | 273 | 26602 | 272 | 52603 | 164 |
| 957 | 220 | 3302N7 | 141 | 14680 | 228 | 23845 | 273 | 26702 | 272 | 52604 | 164 |
| 958 | 218 | 3403F7 | 139 | 15014 | 193 | 24155 | 270 | 26820 | 273 | 52922 | 164 |
| 959 | 218 | 3403N7 | 139 | 15014 | 235 | 24170 | 270 | 26824 | 273 | 53012 | 166 |
| 960 | 218 | 3404J | 139 | 15018 | 193 | 24202 | 155 | 26826 | 273 | 53022 | 166 |
| 963GN | 215 | 3404S7 | 139 | 15018 | 235 | 24202G | 160 | 26827 | 273 | 53706 | 160 |
| 968 | 219 | 3405H7 | 139 | 15020 | 193 | 24355 | 270 | 26828 | 273 | 53706 | 202 |
| 969 | 219 | 3405Q7 | 139 | 15020 | 235 | 24370 | 270 | 26830 | 273 | 53712 | 164 |
| 970 | 219 | 3503F7 | 139 | 15022 | 193 | 24530 | 273 | 26831 | 273 | 53712 | 202 |
| 971 | 219 | 3503N7 | 139 | 15022 | 235 | 24535 | 273 | 26833 | 273 | 55737 | 150 |
| 972 | 222 | 3504J | 139 | 15024 | 193 | 24540 | 273 | 26928 | 270 | 55737 | 189 |
| 972P | 222 | 3504S7 | 139 | 15024 | 235 | 24545 | 273 | 27228 | 251 | 55837 | 150 |
| 972 | 302 | 3505H7 | 139 | 15026 | 193 | 24550 | 273 | 27230 | 251 | 56012 | 151 |
| 972P | 302 | 3505Q7 | 139 | 15026 | 235 | 24710 | 221 | 27233 | 251 | 56012 | 202 |
| 973 | 222 | 3600J | 141 | 15028 | 193 | 24710 | 273 | 27328 | 251 | 56015 | 151 |
| 973P | 222 | 3600S7 | 141 | 15028 | 235 | 24713 | 221 | 27330 | 251 | 56015 | 202 |
| 973 | 302 | 3601H7 | 141 | 15338 | 235 | 24713 | 273 | 27333 | 251 | 56022 | 151 |
| 973P | 302 | 3601Q7 | 141 | 15338 | 254 | 24714 | 221 | 28215 | 242 | 56022G | 159 |
| 974 | 221 | 3602F7 | 141 | 16190 | 358 | 24714 | 273 | 28215 | 244 | 56022V | 159 |
| 975 | 219 | 3602N7 | 141 | 16290 | 358 | 24720 | 221 | 28222 | 242 | 56022 | 202 |
| 976 | 219 | 7001B | 231 | 16440 | 260 | 24720 | 273 | 28222 | 244 | 56032 | 151 |

Index

| | Pag | Pag | Pag | Pag | Pag | Pag | | | | | |
|--------|-----|--------|-----|-------|-----|---------|-----|------------|-----|------------|-----|
| 56032 | 202 | 64112 | 292 | 78140 | 246 | 96535 | 215 | 247075 | 221 | 10001144B | 86 |
| 56123 | 150 | 64116 | 292 | 78214 | 274 | 96540 | 215 | 247075 | 273 | 10001144N | 86 |
| 56123 | 189 | 64202 | 292 | 78218 | 274 | 96545 | 215 | 247100 | 221 | 10001144O | 86 |
| 56315 | 150 | 64204 | 292 | 78220 | 274 | 96550 | 215 | 247100 | 273 | 10001144OI | 86 |
| 56315 | 202 | 64206 | 292 | 78222 | 274 | 96560 | 215 | 247132 | 221 | 10001144 | 243 |
| 56322 | 150 | 64208 | 292 | 78224 | 274 | 96613 | 215 | 247132 | 273 | 10001147 | 104 |
| 56322 | 202 | 64210 | 292 | 78226 | 274 | 96619 | 215 | 247145 | 221 | 10001150 | 104 |
| 56415 | 150 | 64300 | 292 | 78228 | 274 | 96624 | 215 | 247145 | 273 | 10001150 | 316 |
| 56422 | 150 | 64301 | 292 | 78830 | 134 | 96627 | 215 | 280120 | 324 | 10001151 | 301 |
| 56422G | 158 | 64302 | 292 | 78850 | 134 | 96635 | 215 | 280122 | 324 | 10001175 | 84 |
| 56422V | 158 | 64304 | 292 | 79230 | 134 | 96640 | 215 | 280124 | 324 | 10001175B | 84 |
| 57220 | 242 | 64306 | 292 | 79250 | 134 | 96727 | 215 | 281109 | 324 | 10001175N | 84 |
| 57234 | 242 | 64308 | 292 | 79715 | 135 | 96735 | 215 | 281114 | 324 | 10001175O | 84 |
| 57262 | 242 | 64310 | 292 | 79720 | 135 | 96740 | 215 | 281116 | 324 | 10001175OI | 84 |
| 58912 | 342 | 64312 | 292 | 83422 | 237 | 97413 | 287 | 282112 | 324 | 10001175 | 209 |
| 58922 | 342 | 64316 | 292 | 83434 | 237 | 97419 | 287 | 282120 | 324 | 10061101 | 118 |
| 58928 | 135 | 64402 | 292 | 84331 | 265 | 97713 | 216 | 282122 | 324 | 10061102 | 118 |
| 58928 | 309 | 64402P | 292 | 86320 | 237 | 97719 | 216 | 282124 | 324 | 10061103 | 118 |
| 58928 | 342 | 64404 | 292 | 86420 | 237 | 97803 | 217 | 282128 | 324 | 10061104 | 118 |
| 58970 | 310 | 64404P | 292 | 87504 | 147 | 98402 | 221 | 283124 | 324 | 10061105 | 118 |
| 59870 | 310 | 64406 | 292 | 87508 | 147 | 98402 | 287 | 283128 | 324 | 10061106 | 118 |
| 61322 | 149 | 64406P | 292 | 92727 | 218 | 100222 | 130 | 284122 | 325 | 10061107 | 118 |
| 61340 | 149 | 64408 | 292 | 92735 | 218 | 100240 | 130 | 284126 | 325 | 10061110 | 119 |
| 61422 | 149 | 64408P | 292 | 92740 | 218 | 120120 | 331 | 284130 | 325 | 10061111 | 119 |
| 61440 | 149 | 64504 | 292 | 92830 | 218 | 120124 | 331 | 290576 | 249 | 10061115 | 118 |
| 61739 | 149 | 64506 | 292 | 92835 | 218 | 121116 | 331 | 430350 | 239 | 10061116 | 118 |
| 62101 | 291 | 64512 | 292 | 92840 | 218 | 122120 | 331 | 430491 | 269 | 10061120 | 119 |
| 62102 | 291 | 64604 | 291 | 92845 | 218 | 122124 | 331 | 430491SS | 269 | 10061121 | 119 |
| 62104 | 291 | 64606 | 291 | 92850 | 218 | 123128 | 331 | 430510SS | 239 | 10061122 | 119 |
| 62106 | 291 | 64612 | 291 | 92860 | 218 | 124126 | 331 | 430510SS | 239 | 10061123 | 119 |
| 62108 | 291 | 65102 | 295 | 93612 | 224 | 150008 | 334 | 430510ST | 268 | 10061140 | 119 |
| 62110 | 291 | 65104 | 295 | 93622 | 224 | 150014 | 334 | 430511SS | 274 | 10061142 | 119 |
| 62112 | 291 | 65106 | 295 | 93628 | 224 | 150120 | 334 | 430602 | 269 | 10101136 | 88 |
| 62116 | 291 | 65108 | 295 | 94003 | 225 | 150122 | 334 | 647150 | 292 | 10101136 | 243 |
| 62202 | 291 | 65110 | 295 | 94003 | 287 | 150124 | 334 | 648150 | 291 | 10131140 | 274 |
| 62204 | 291 | 65112 | 295 | 94003 | 293 | 151116 | 334 | 720411 | 209 | 10141136 | 88 |
| 62206 | 291 | 65116 | 295 | 94004 | 225 | 152120 | 334 | 720419 | 209 | 10141136 | 243 |
| 62208 | 291 | 65202 | 295 | 94004 | 287 | 152122 | 334 | 799906 | 211 | 10201110 | 210 |
| 62210 | 291 | 65204 | 295 | 94004 | 293 | 152124 | 334 | 799909 | 211 | 10201111 | 210 |
| 62301 | 291 | 65206 | 295 | 94005 | 224 | 153126 | 334 | 10001108 | 282 | 10201116 | 210 |
| 62302 | 291 | 65208 | 295 | 94005 | 293 | 153130 | 334 | 10001109 | 106 | 10201122 | 210 |
| 62304 | 291 | 65301 | 295 | 94414 | 224 | 157122 | 337 | 10001110 | 106 | 10201123 | 210 |
| 62306 | 291 | 65302 | 295 | 94418 | 224 | 157222 | 337 | 10001110 | 209 | 10201136 | 88 |
| 62308 | 291 | 65304 | 295 | 94420 | 224 | 157830 | 337 | 10001111 | 106 | 10201136 | 243 |
| 62310 | 291 | 65306 | 295 | 94422 | 224 | 157922 | 336 | 10001111 | 209 | 10201140 | 210 |
| 62312 | 291 | 65308 | 295 | 94424 | 224 | 157926 | 336 | 10001115 | 106 | 10201141 | 210 |
| 62316 | 291 | 65310 | 295 | 94426 | 224 | 157930 | 336 | 10001116 | 106 | 10201142 | 210 |
| 62402 | 291 | 65312 | 295 | 94428 | 224 | 180120 | 322 | 10001116 | 209 | 10201143 | 104 |
| 62402P | 291 | 65316 | 295 | 94514 | 224 | 180120O | 326 | 10001120 | 106 | 10201143 | 210 |
| 62404 | 291 | 65402 | 295 | 94518 | 224 | 180122 | 322 | 10001121 | 106 | 10201144 | 104 |
| 62404P | 291 | 65404 | 295 | 94520 | 224 | 180122O | 326 | 10001122 | 106 | 10201144 | 299 |
| 62406 | 291 | 65406 | 295 | 94522 | 224 | 180124 | 322 | 10001122 | 209 | 10231136 | 88 |
| 62406P | 291 | 65408 | 295 | 94524 | 224 | 180124O | 326 | 10001123 | 106 | 10231136 | 243 |
| 62408 | 291 | 67301 | 232 | 94526 | 224 | 181109 | 322 | 10001123 | 209 | 10341136 | 88 |
| 62408P | 291 | 67301 | 306 | 94528 | 224 | 181109O | 326 | 10001124 | 106 | 10341136 | 243 |
| 63102 | 294 | 67304 | 232 | 94614 | 224 | 181114 | 322 | 10001125 | 104 | 10341146 | 96 |
| 63104 | 294 | 67304 | 306 | 94618 | 224 | 181114O | 326 | 10001126 | 104 | 10341146B | 96 |
| 63106 | 294 | 67701 | 304 | 94620 | 224 | 181116 | 322 | 10001127 | 106 | 10341146N | 96 |
| 63108 | 294 | 67704 | 304 | 94622 | 224 | 181116O | 326 | 10001128 | 82 | 10341146O | 96 |
| 63110 | 294 | 68702 | 199 | 94624 | 224 | 182112 | 322 | 10001128B | 82 | 10341146OI | 96 |
| 63112 | 294 | 69202 | 199 | 94626 | 224 | 182112O | 326 | 10001128N | 82 | 10341146 | 163 |
| 63116 | 294 | 70110 | 274 | 94628 | 224 | 182118 | 322 | 10001128O | 82 | 10521108 | 102 |
| 63202 | 294 | 70115 | 274 | 95014 | 216 | 182118O | 326 | 10001128OI | 82 | 10521108 | 206 |
| 63204 | 294 | 70130 | 274 | 95020 | 216 | 182120 | 322 | 10001129 | 92 | 10521131 | 102 |
| 63206 | 294 | 72611 | 278 | 95024 | 216 | 182120O | 326 | 10001129 | 163 | 10521131 | 206 |
| 63208 | 294 | 72620 | 278 | 95028 | 216 | 182122 | 322 | 10001129 | 175 | 10701136 | 88 |
| 63301 | 294 | 73112 | 274 | 95104 | 220 | 182122O | 326 | 10001133 | 98 | 10711136 | 88 |
| 63302 | 294 | 73214 | 274 | 95106 | 220 | 182124 | 322 | 10001133B | 98 | TU0687G | 199 |
| 63304 | 294 | 73218 | 274 | 95202 | 220 | 182124O | 326 | 10001133N | 98 | TU0692V | 199 |
| 63306 | 294 | 73220 | 274 | 95206 | 220 | 183124 | 322 | 10001133O | 98 | | |
| 63308 | 294 | 73222 | 274 | 95302 | 220 | 183124O | 326 | 10001133OI | 98 | | |
| 63310 | 294 | 73224 | 274 | 95304 | 220 | 183128 | 322 | 10001136 | 88 | | |
| 63312 | 294 | 73226 | 274 | 95406 | 220 | 183128O | 326 | 10001136 | 243 | | |
| 63316 | 294 | 73228 | 274 | 95613 | 276 | 184122 | 323 | 10001138 | 104 | | |
| 63404 | 294 | 73614 | 274 | 96330 | 215 | 184122O | 327 | 10001139 | 94 | | |
| 63406 | 294 | 73618 | 274 | 96335 | 215 | 184126 | 323 | 10001139B | 94 | | |
| 63408 | 294 | 73620 | 274 | 96340 | 215 | 184126O | 327 | 10001139N | 94 | | |
| 63510 | 294 | 73622 | 274 | 96345 | 215 | 184130 | 323 | 10001139O | 94 | | |
| 63516 | 294 | 73624 | 274 | 96350 | 215 | 184130O | 327 | 10001139OI | 94 | | |
| 64101 | 292 | 73626 | 274 | 96360 | 215 | 213132 | 333 | 10001139 | 104 | | |
| 64102 | 292 | 73628 | 274 | 96440 | 215 | 217828 | 333 | 10001140 | 104 | | |
| 64104 | 292 | 74116 | 276 | 96445 | 215 | 217920 | 332 | 10001141 | 106 | | |
| 64106 | 292 | 78125 | 246 | 96450 | 215 | 217924 | 332 | 10001142 | 106 | | |
| 64108 | 292 | 78130 | 246 | 96460 | 215 | 217928 | 332 | 10001142 | 209 | | |
| 64110 | 292 | 78135 | 246 | 96530 | 215 | 217932 | 332 | 10001144 | 86 | | |



Ci mettiamo il cuore



HOTEL Catalog



www.mepra.it



HOTEL Catalog USA



HOTEL Catalog



25065 LUMEZZANE - BRESCIA - ITALIA - VIA MONTINI 176
TEL. 0308921441 - FAX 0308925075 - MEPRA@MEPRA.IT
WWW.MEPRA.COM